



## ÍNDICE

GLOSSÁRIO	4-5
CANDEEIROS SUSPENSOS	6-87
CANDEEIROS DE TETO	88-175
CANDEEIROS DE PAREDE	176-265
FOCOS	266-317
CANDEEIROS DE MESA	318-347
CANDEEIROS DE PÉ	348-371
LUZES EMBUTIDAS	372-481
CALHAS TRIFÁSICAS	482-531
SISTEMA DE CALHAS MONOFÁSICAS	532-555
FITAS LED	556-565
ABAJURES E ACESSÓRIOS	566-619
ILUMINAÇÃO EXTERIOR	620-725
FONTES DE LUZ	726-743
ACESSÓRIOS PARA CANDEEIROS	744-751
LISTA ALFABÉTICA DE LUZES	752-755
IDENTIFICAÇÃO ÍNDICE	756-759

# GLOSSÁRIO



## NOME

Descrição

## PRODUTO

230 V/350 mA LED... Informação técnica

IDENTIFICAÇÃO DO ARTIGO cor / material

PREÇO ➔



↑ 50

● Ø40

● LED

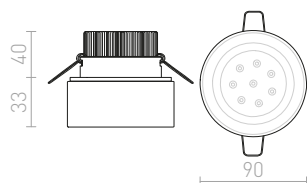

- está incluído
- não está incluído
- ↑ profundidade necessária (em mm)
- diâmetro do furo redondo (em mm)
- ▣ dimensão do furo quadrado (em mm)
- ∠ 20° ângulo de inclinação
- ∠ 90° ângulo de rotação
- 44 dimensão (em mm)
- NEW novo
- % mercadorias a preço reduzido
- ➔ stock de apuramento, descontinuado

Os valores do fluxo luminoso especificados são valores nominais gerados pela fonte de luz. O fluxo luminoso será menor devido à perda causada pela parte óptica da fixação.

Os valores específicos do consumo de energia são os valores nominais do consumo pela fonte de luz. O consumo de energia total do acessório será aumentado pela perda causada pela resistência.

O fabricante reserva-se ao direito de fazer alterações nos parâmetros dos produtos individuais durante a validade do catálogo.

% e ➔ – produtos estão em quantidade limitada e sua disponibilidade não é garantida durante a validade do catálogo.

## GARANTIA ALARGADA

A garantia padrão fornecida a todos os clientes É DE DOIS ANOS.

Uma GARANTIA ALARGADA CONTRATUAL pode ser providenciada para um projeto individual maior. É determinado pelo tipo de mercadoria, volume e duração da garantia. Peça uma cotação.

## EXCLUSÃO DE RESPONSABILIDADE

As alterações estão sujeitas a aviso prévio. Erros e omissões são reservados. Verifique sempre se está a consultar a versão mais recente.

Ao usar outras fontes de luz ou acessórios que não sejam os recomendados por nós, não podemos garantir a funcionalidade da lâmpada.

## IP REQUERIDO

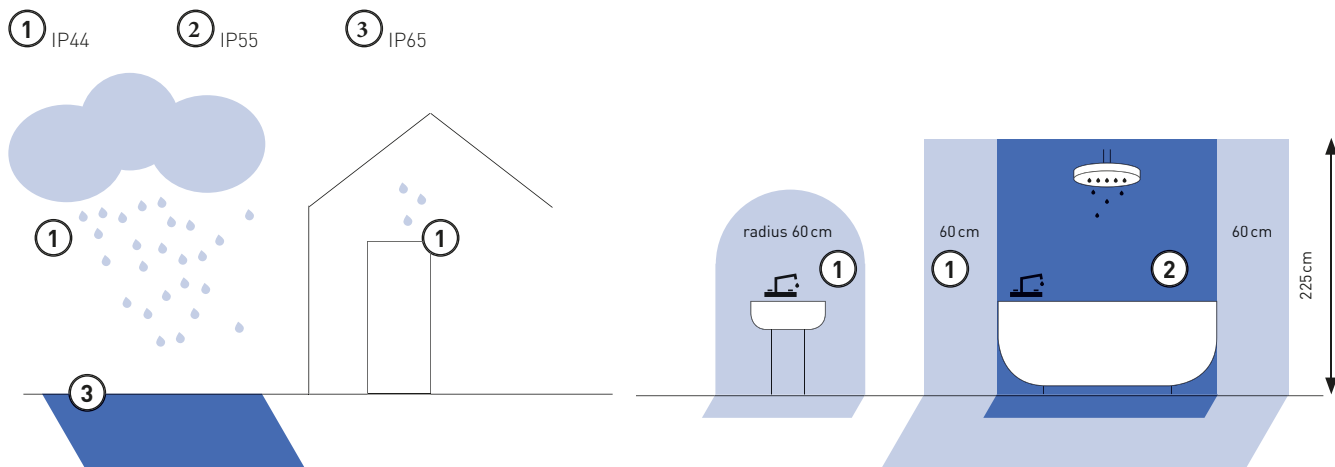

## INSTALAÇÃO DE LUZES EXTERNAS EMBUTIDAS

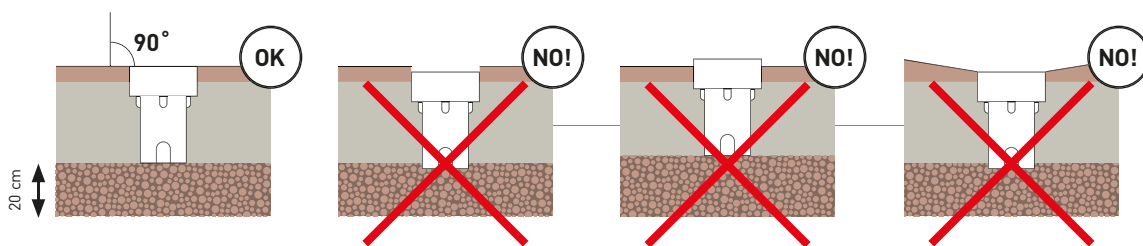

**LED** Integrado

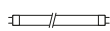

**T5** Tubo fluorescente

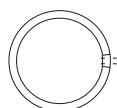

**2GX13** Tubo fluorescente



G11841

Fonte recomendada, mais informações na categoria Fontes de luz.



Transformador não regulável.



regulável

Luz com driver TRIAC regulável.



regulamento opcional

Por um custo adicional, a luz pode ser fornecida com um interruptor ajustável.



G13002

Driver recomendado, mais informações na categoria Acessórios para candeeiros.



Interruptor de alavanca



Interruptor de toque com regulação



Interruptor no cabo



Interruptor de empurrar



Interruptor de puxar



Interruptor elétrico



Interruptor de toque



Interruptor rotativo



**PIR**

Sensor PIR, sensor de movimento por infravermelhos.



**MW**

Sensor MW, Sensor de movimento por microondas.



1800K → 3000K  
**DIMM TO WARM**

**DIMM TO WARM**, controlo de temperatura de cor da luz.



## CANDEEIROS SUSPENSOS

DECORATIVO	14-31
MÚLTIPLO	32-33
VIDRO	34-51
AJUSTÁVEL	52-57
METÁLICO	58-73
TÉCNICO, CIRCULAR	74-77
TÉCNICO, ANGULAR	78-81
OBLONGO	82-85
INDUSTRIAL	86-87

# SUSPENSOS DECORATIVO



**FLORIDA**  
14-15



**HEIDI**  
14-15



**RADICAL**  
14-15

14-31



**ELLA**  
14-15



**CAMINO**  
16-17



**BURTON**  
16-17



**ILUSIA**  
16-17



**JACK RC**  
16-17



**ESME 76**  
18-19



**NANCY III**  
18-19



**TUTTI**  
18-19



**FRUTTI**  
18-19



**ENCOMBRE**  
20-21



**CONFETTI**  
20-21



**COCO**  
20-21



**ZALA**  
22-23



**RARA**  
22-23



**EZRA 40**  
22-23



**CLANK**  
22-23



**BUCKY 40**  
24-25



**VESCO**  
24-25



**JAMAICA 34**  
24-25



**POLLOCK**  
24-25



**ESPLANADE**  
26-27



**ICAR**  
26-27



**CHOUPEPTE**  
26-27



**AMICI**  
26-27



**FIATLUX 41/24**  
28-29



**FANCY 35/25**  
28-29



**FANCY 50/30**  
28-29



**GLAMOUR 35/20**  
28-29



**LALO 55**  
30-31



**LALO 40**  
30-31



**LOPE 80**  
30-31



**AINO 40**  
30-31

## SUSPENSOS MÚLTIPLO

32-33



**ASTRAL**  
32-33



**ASTROMET VII**  
32-33



**CINDY VI**  
32-33

## SUSPENSOS VIDRO

34-51



**BEAU MONDE 25**  
34-35



**BEAU MONDE 30**  
34-35



**BEAU MONDE 35**  
34-35



**LUNA 20**  
36-37



**LUNA 25**  
36-37



**LUNA 30**  
36-37



**BOLLY 17**  
36-37



**LUNEA 30**  
38-39



**LUNEA 40**  
38-39



**LUNEA 50**  
38-39



**JULIETTA 16**  
40-41



**JULIETTA 31**  
40-41



**BABU NEW 22**  
40-41





**BELLINI L E14**  
42-43



**BELLINI M LED**  
42-43



**AZRIA**  
42-43



**CORONA**  
42-43



**PULIRE CON**  
44-45



**PULIRE RD**  
44-45



**COROA NEW 28**  
44-45



**SANSSOUCI I**  
46-47



**SANSSOUCI I**  
46-47



**GARNISH**  
46-47



**EIGHT**  
46-47



**TOMBA**  
46-47



**ESTRA V**  
48-49



**ESTRA I**  
48-49



**GIFT I**  
48-49



**DADOS NEW**  
50-51



**LIZ NEW**  
50-51



**DADOS III 60**  
50-51



**DADOS III 80**  
50-51



**LIZ III 60**  
50-51



**LIZ III 80**  
50-51

## SUSPENSOS AJUSTÁVEL

52-57



**BROADWAY**  
52-53



**LEVITA**  
52-53



**BROADWAY**  
54-55



**MADISON C**  
54-55



**LOYD LED I**  
56-57



**LOYD E27 I**  
56-57



**LOYD E27 III**  
56-57

SUSPENSOS  
**METÁLICO**

58-73



**GIULIA 12**  
58-59



**GIULIA 20**  
58-59



**GIULIA 40**  
58-59



**MAVRO**  
60-61



**RIGA 28**  
60-61



**STIG**  
60-61



**BOGARD**  
62-63



**BELENOS**  
62-63



**OPTIMUS**  
62-63



**AGNETA**  
64-65



**COPA**  
64-65



**DESTY I**  
64-65



**ARAQ**  
64-65



**ASTON 28**  
66-67



**ASTON 30**  
66-67



**BLONDIE 25**  
66-67



**MARGO**  
66-67



**MONROE 30**  
68-69



**MONROE 40**  
68-69



**SINTRA 40**  
68-69



**SINTRA 30**  
68-69



**BABADES I**  
70-71



**BABADES IV**  
70-71



**CARISSIMA 25**  
70-71



**CARISSIMA 40**  
70-71



**GOLDIE 36**  
72-73



**GOLDIE 46**  
72-73



**MERYLYN 48**  
72-73

## SUSPENSOS TÉCNICO, CIRCULAR

74-77



**MEZZO 40**  
74-75



**MEZZO 60**  
74-75



**MEZZO 40/60**  
74-75



**MEZZO 80**  
74-75



**MEZZO 80**  
74-75



**MONETA**  
76-77



**LARISA R 30**  
76-77



**CASSABLANCA 40**  
76-77



**ASTERI**  
76-77

## SUSPENSOS TÉCNICO, ANGULAR

78-81



**MENSA SQ 48**  
78-79



**MENSA RC**  
78-79



**LARISA SQ 30**  
78-79



**STRUCTURAL LED 20x20**  
80-81



**STRUCTURAL LED 40x40**  
80-81



**STRUCTURAL LED 55x55**  
80-81

## SUSPENSOS OBLONGO



**PESANTE 35**  
82-83



**PESANTE 75**  
82-83



**TRIDENT PRO 120**  
84-85

82-85



**TRIDENT PRO 150**  
84-85



**TRIDENT PRO**  
84-85

## SUSPENSOS INDUSTRIAL



**MEGALOS PRO 26**  
86-87



**MEGALOS PRO 30**  
86-87



**MEGALOS PRO 35**  
86-87

86-87



## ELLA

Luminária suspensa de gesso para fonte LED com casquilho E27. Base do teto em metal lacado a branco. A luminária pode ser pintada com tintas para interiores.

**ELLA SUSPENSO**  
230 V LED E27 15 W

**R13788** gesso

**€ 120**

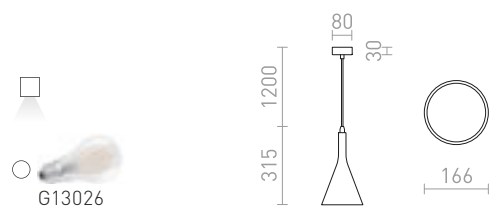



## FLORIDA

Candeeiro suspenso de cerâmica texturada para fontes de luz E27.

### FLORIDA SUSPENSO

230 V E27 28 W

R13298 cerâmica

€ 98

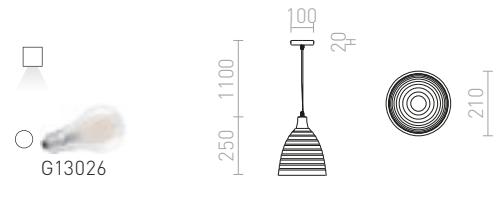

## RADICAL

Candeeiro suspenso em cimento maciço com ligação de cabo e cabo independente para fonte de luz E27.

### RADICAL SUSPENSO

230 V E27 28 W

R12416 cimento

€ 158

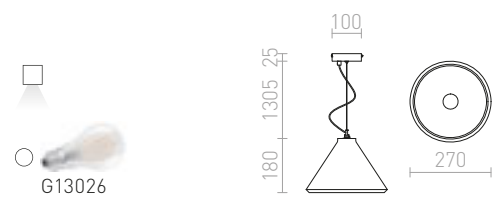

## HEIDI

Luminária cônica em cimento suspensa com tampa em madeira para fonte de luz com casquilho E27.

### HEIDI SUSPENSO

230 V E27 28 W

R12380 cimento/madeira

€ 98

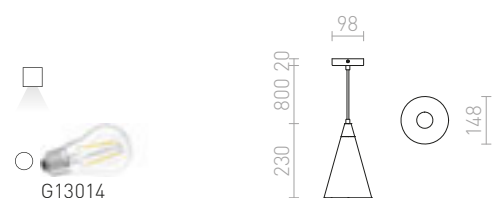



## ILUSIA

Luminária suspensa com cortina de arame e cabo têxtil para uso com uma fonte de luz E27 adequada.

### ILUSIA SUSPENSO

230 V E27 42 W

R13892 preto

€ 68

NEW

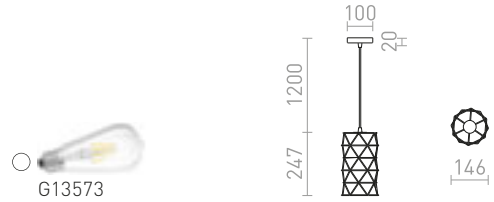

## BURTON

Luminária de cimento suspenso com abajur e arames metálicos para fontes de luz E27.

### BURTON SUSPENSO

230 V E27 42 W

R12931 cimento

€ 88

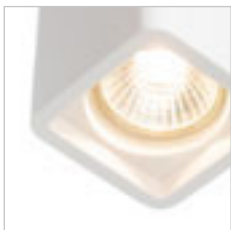

## JACK

Luminária suspensa de gesso para fonte de luz com casquilho GU10. Base do teto em metal lacado a branco. A luminária pode ser pintada com tintas para interiores.

### JACK RC SUSPENSO

230 V GU10 35 W

R11676 gesso

€ 68

%

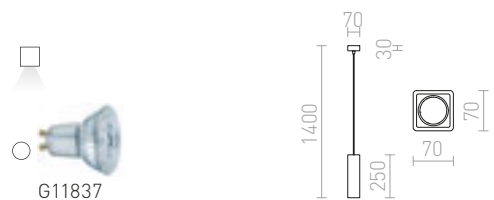



## CAMINO

Candeeiro suspenso, de forma cilíndrica para fontes de luz E27. Cada base tem o seu acabamento exclusivo.

### CAMINO SUSPENSO

230 V E27 28 W

**R13296** terrazzo decor

€ 88

**R13297** cimento

€ 88

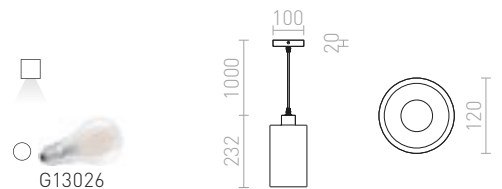





## TUTTI

Candeeiro suspenso com abajur cónico com luz descendente para fontes de luz E27.

### TUTTI SUSPENSO

230 V E27 15 W

R13289 laranja/cerâmica

€ 58 →

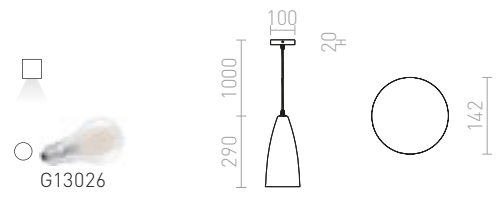

## FRUTTI

Candeeiro suspenso para fontes de luz E27.

### FRUTTI SUSPENSO

230 V E27 28 W

R13290 verde/cerâmica

€ 48 →

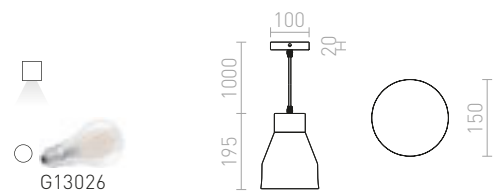



## NANCY

Candeeiro suspenso com uma base e três abajures de tecido, para três fontes de luz E14.

### NANCY III SUSPENSO

230 V E14 3x11 W

R13345 branco/vermelho

€ 48 %

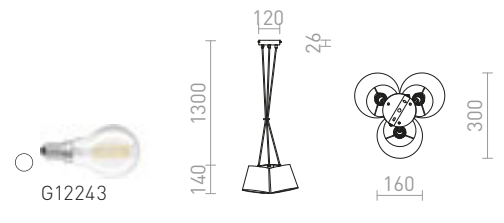

## ESME

Candeeiro suspenso com abajur cônico oblongo branco e o interior cor de laranja.

### ESME 76 SUSPENSO

230 V E27 28 W

R13276 branco/laranja

€ 68 %

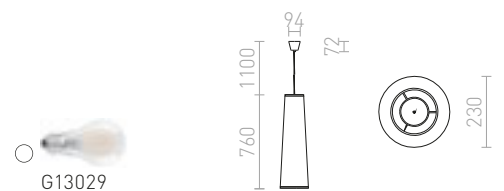



## ENCOMBRE

Luminária decorativa suspensa feita de pétalas de plástico disponível em três cores. Fornecido desmontado, montagem necessária.

### ENCOMBRE SUSPENSO

230 V E27 42 W

**R12381** PVC branco

€ 138

**R12382** folha de cromo

€ 158

**R12383** folha de cobre

€ 178



G13026

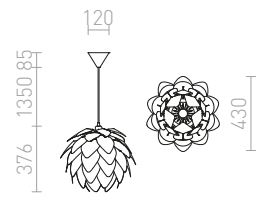

## COCO

Luminária decorativa suspensa feita de elementos plásticos com design de botões de rosa. Fornecido desmontado, montagem necessária.

### COCO SUSPENSO

230 V E27 28 W

**R12384** PVC branco

€ 220



G13026

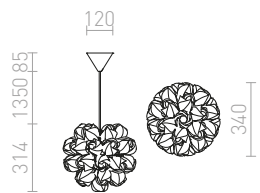



## CONFETTI

Candeeiro divertido com camadas de grandes lantejoulas feitas de lâmina cromada. Fornecido desmontado, montagem necessária.

### CONFETTI SUSPENSO

230 V E27 28 W

R13285 folha de cromo

€ 88

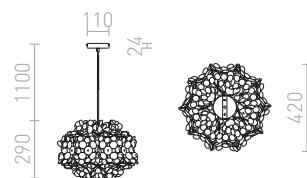
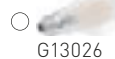



## ZALA

Candeeiro suspenso com tiras decorativas de plástico. Fornecido desmontado, montagem necessária.

### ZALA SUSPENSO

230 V E27 15 W

R13315 PVC branco/preto

€ 48 %

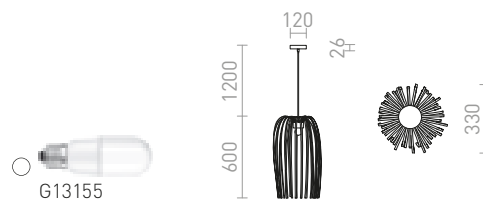

## RARA

Candeeiro suspenso com tiras decorativas de plástico. Fornecido desmontado, montagem necessária.

### RARA SUSPENSO

230 V E27 15 W

R13316 PVC branco/preto

€ 48 %

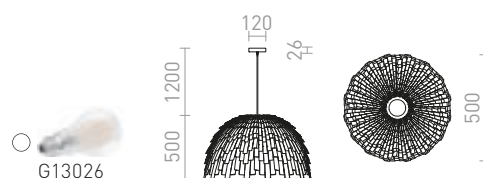



## CLANK

Candeeiro suspenso com tiras decorativas de plástico. Fornecido desmontado, montagem necessária.

### CLANK SUSPENSO

230 V E27 15 W

R13321 PVC branco/preto

€ 68 %

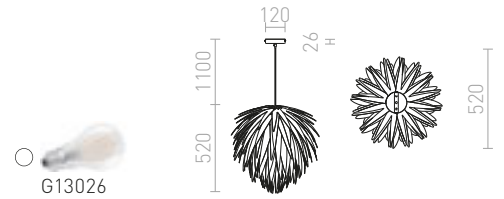

## EZRA

Abajur de plástico redondo com textura decorativa. Fornecido desmontado, montagem necessária.

### EZRA 40 SUSPENSO

230 V E27 15 W

R13319 PVC branco/cinza

€ 48 %

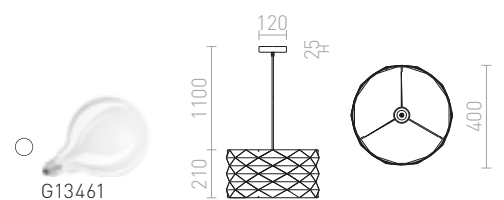



## JAMAICA

Abajur trançado de material natural com formato cónico.

### JAMAICA 34 SUSPENSO

230 V E27 15 W

R13397 natural

€ 78 →



G13026

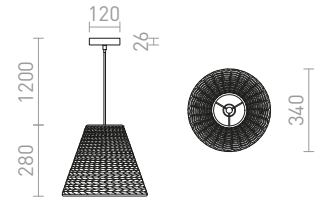

## POLLOCK

Candeeiro têxtil suspenso com difusor embutido cinzento.

### POLLOCK SUSPENSO

230 V E27 28 W

R13280 branco/cinzeno claro

€ 68 →



G13461

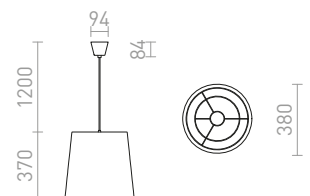



## VESCO

Luminária suspensa com abajur metálico envernizado.

### VESCO SUSPENSO

230 V E27 42 W

R10536 preto

€ 129 %

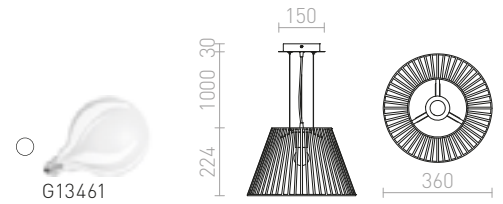

## BUCKY

Candeeiro suspenso de metal com textura martelada.

### BUCKY 40 SUSPENSO

230 V E27 28 W

R13360 branco/cinza/metal

€ 129 %

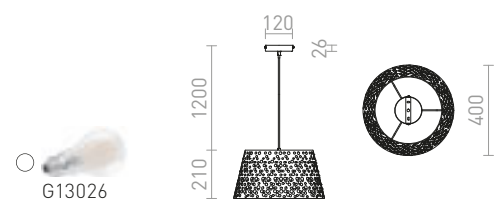





## ESPLANADE

Candeeiro suspenso com abajur têxtil duplo.

### ESPLANADE SUSPENSO

230 V E27 42 W

R12483 preto transparente/branco/cromo

€ 335



G13029

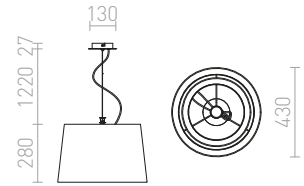



### AMICI

Luminária suspensa com abajur de silicone.

#### AMICI SUSPENSO DE SILICONE

230 V E27 42 W

R10620 verde

€ 10.50 %

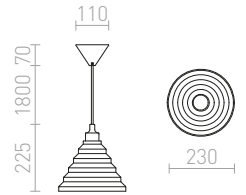

### CHOUETTE

Luminária suspensa em tecido com acessório em madeira para fonte de luz LED com casquilho E27.

#### CHOUETTE SUSPENSO

230 V E27 15 W

R13650 cinzento escuro/têxtil/madeira

€ 120

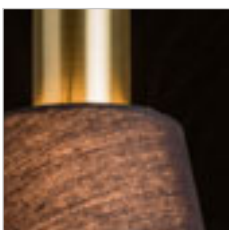
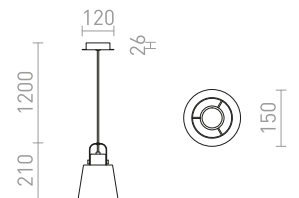

### ICAR

Candeeiro suspenso minimalista com abajur têxtil.

#### ICAR SUSPENSO

230 V E27 15 W

R12418 preto/ouro

€ 120

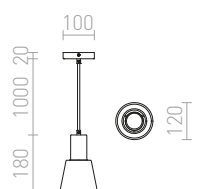



## FIATLUX

Candeeiro suspenso preto de bambu.

### FIATLUX 41/24 SUSPENSO

230 V E27 15 W

R13398 preto/bambu

€ 88 

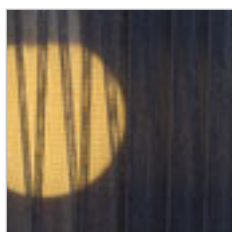
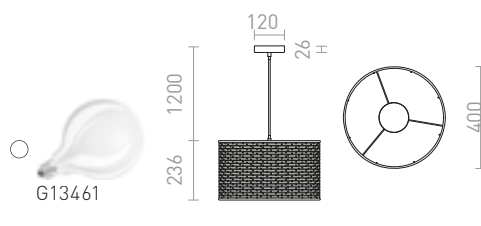

## GLAMOUR

Candeeiro suspenso com abajur em fitas pretas.

### GLAMOUR 35/20 SUSPENSO

230 V E27 28 W

R13271 preto

€ 48 

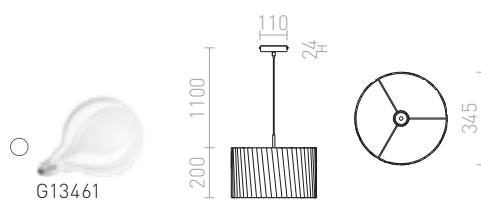



## FANCY

Candeeiro suspenso decorativo com abajur em folha de cromo. Quando a lâmpada está acesa, ela torna-se semi-transparente e, quando desligada, possui uma superfície refletora.

### FANCY 35/25 SUSPENSO

230 V E27 15 W

R13418 folha de cromo

€ 120

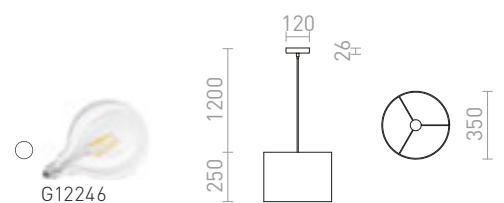

### FANCY 50/30 SUSPENSO

230 V E27 20 W

R13419 folha de cromo

€ 150

R13748 película fumada

€ 178

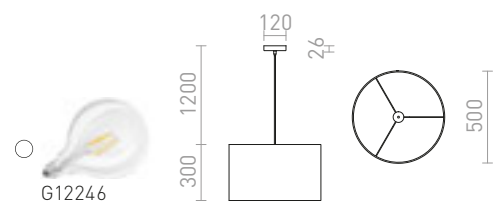



## AINO

Candeeiro suspenso com abajur padrão de malha cinzento.

### AINO 40 SUSPENSO

230 V E27 28 W

R13275 cinzento/cromo

€ 129 %

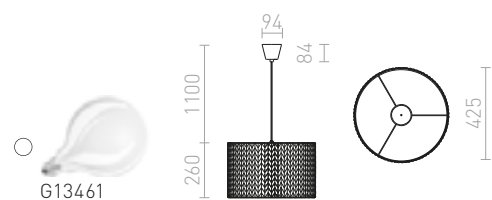



## LALO

Candeeiro suspenso com abajur finamente plissado de cor creme. A luminária tem casquilho E27, revestido com difusor acrílico mate.

### LALO 40 SUSPENSO

230 V E27 3x42 W

R10605 branco creme/níquel mate

€ 215 %

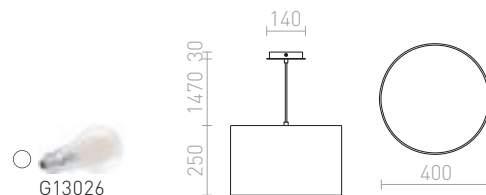

### LALO 55 SUSPENSO

230 V E27 3x42 W

R10540 branco creme/níquel mate

€ 229 %

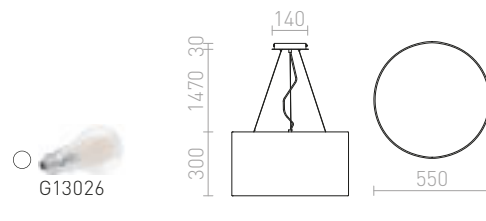

## LOPE

Luminária suspensa com abajur finamente plissado em preto para quatro fontes de luz com casquilho E27. As fontes de luz são cobertas com um difusor acrílico mate.

### LOPE 80 SUSPENSO

230 V E27 4x42 W

R10539 preto/níquel mate

€ 120 %

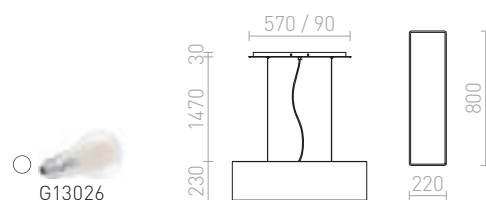

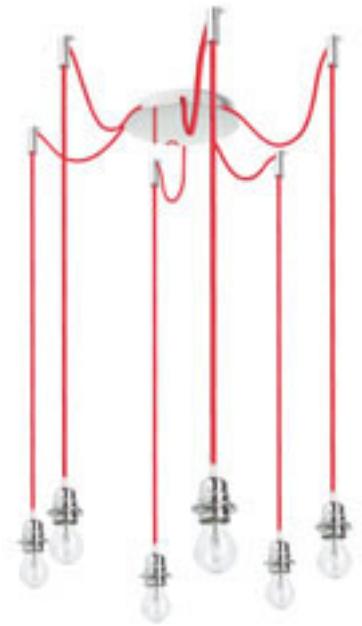

Outras versões do conjunto suspenso **KOMBIX** podem ser encontradas na categoria **Abajures e acessórios**.



## CINDY

Luminária suspensa com base de teto central e seis dobradiças individuais com casquilho E27. As dobradiças estão equipadas com suportes de teto que podem ser colocados a uma distância individual da base. Comprimento total do cabo 2 m.

### CINDY VI SUSPENSO

230 V E27 6x42 W

R12054 preto

€ 238

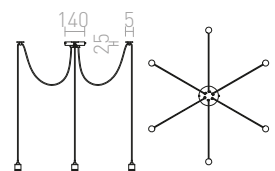



## ASTRAL

Luminária suspensa de design elegante com abajures de vidro semi-colorido. Os abajures podem ser montados em várias formas. Um anel decorativo é usado para ajustar o ângulo de inclinação.

### ASTRAL SUSPENSO

230 V/12 V G4 10x20 W

**R10513** vidro cromado/vidro transparente € 560

**R11706** vidro tingido de cobre/vidro transparente € 645

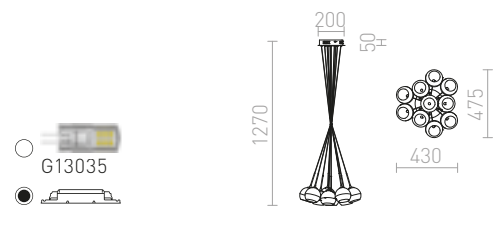

## ASTROMET

Luminária suspensa composta por sete esferas de cromo anexadas a uma base de teto, com casquilhos E27.

### ASTROMET VII SUSPENSO

230 V E27 7x42 W

**R11761** cromo € 320

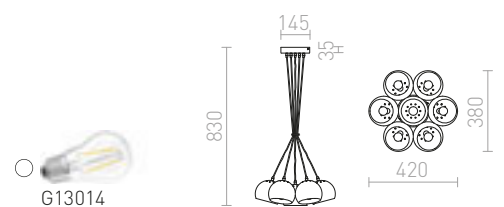







## BEAU MONDE

Luminária suspensa com abajur de vidro soprado à mão. A aparência do espelho do abajur é conseguida por um método especial no qual uma fina camada de metal é aplicada ao vidro. Para fontes de luz E27 de baixo consumo energético. O processo de fabrico origina pequenas bolhas no vidro, não sendo defeitos, são efeitos causados na sua fabricação.

### BEAU MONDE 25 SUSPENSO

230 V E27 25 W

R10517 vidro tingido de cobre

€ 198

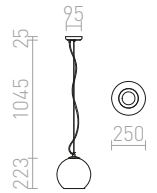

## BEAU MONDE

Luminária suspensa com abajur de vidro soprado à mão. A aparência do espelho do abajur é conseguida por um método especial no qual uma fina camada de metal é aplicada ao vidro. Para fontes de luz E27 de baixo consumo energético. O processo de fabrico origina pequenas bolhas no vidro, não sendo defeitos, são efeitos causados na sua fabricação.

### BEAU MONDE 30 SUSPENSO

230 V E27 25 W

R10518 vidro cromado

€ 278

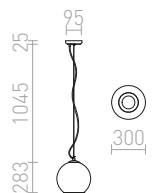

## BEAU MONDE

Luminária suspensa com abajur de vidro soprado à mão. A aparência do espelho do abajur é conseguida por um método especial no qual uma fina camada de metal é aplicada ao vidro. A parte inferior do abajur é feita de vidro transparente. Para fontes de luz E27 de baixo consumo energético. O processo de fabrico origina pequenas bolhas no vidro, não sendo defeitos, são efeitos causados na sua fabricação.

### BEAU MONDE 35 SUSPENSO

230 V E27 25 W

R10516 vidro cromado/vidro transparente

€ 320

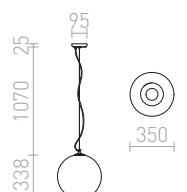



IP44

## BOLLY

Luminária suspensa com vidro opalino e acessórios cromados. Adequado para ambientes húmidos.

### BOLLY 17 SUSPENSO

230 V LED E27 15 W IP44

R13692 vidro colorido opala/cromo

€ 178



G13307

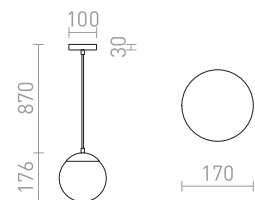



## LUNA

Luminária suspensa em vidro opalino com acessórios cromados e cabo transparente.

### LUNA 20 SUSPENSO

230 V LED E27 15 W

**R13745** vidro colorido opala/cromo

**€ 120**

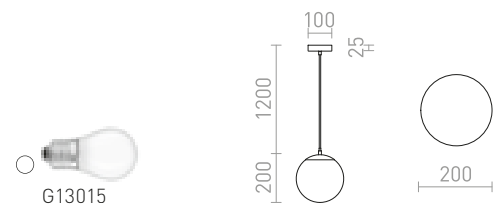

### LUNA 25 SUSPENSO

230 V LED E27 15 W

**R13746** vidro colorido opala/cromo

**€ 150**

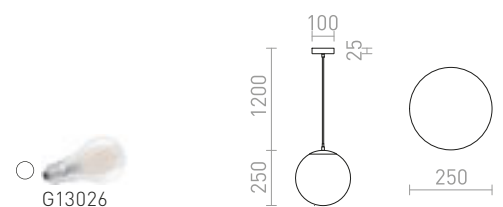

### LUNA 30 SUSPENSO

230 V LED E27 15 W

**R13747** vidro colorido opala/cromo

**€ 198**

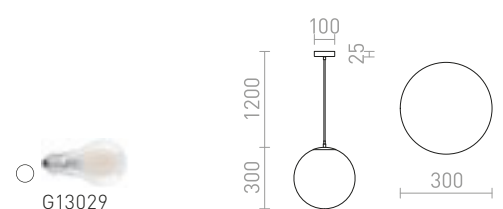



## LUNEA

Luminária suspensa com esfera de vidro triplex em cor opala. O cabo de suspensão é separado do cabo de alimentação. Cabo transparente e detalhes cromados.

### LUNEA 30 TRIPLEX SUSPENSO

230 V E27 70 W

R10478 vidro colorido opala

€ 178

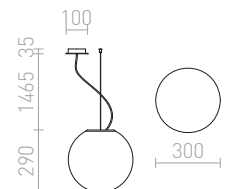

### LUNEA 40 TRIPLEX SUSPENSO

230 V E27 70 W

R10479 vidro colorido opala

€ 320

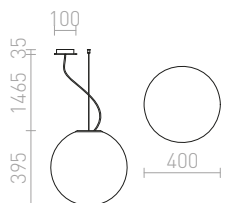

### LUNEA 50 TRIPLEX SUSPENSO

230 V E27 100 W

R11715 vidro colorido opala

€ 450

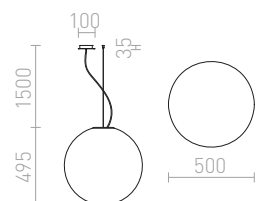







## BABU NEW

Luminária suspensa com abajur de vidro, disponível em duas cores. Base de teto em cromo.

### BABU NEW 22 SUSPENSO

230 V E27 53 W

**R13826** vidro transparente/cromo

€ 178

**R13827** vidro colorido opala/cromo

€ 178

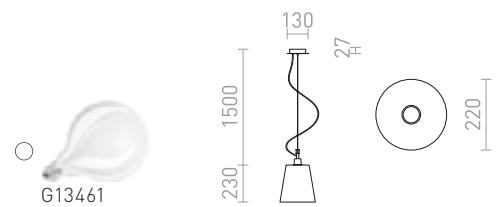

## JULIETTA

Luminária suspensa decorativa de design em vidro cilíndrico opalino. Elementos de metal pintado, cabo têxtil preto.

### JULIETTA 16 SUSPENSO

230 V E27 20 W

**R13752** vidro colorido opala/preto

€ 120

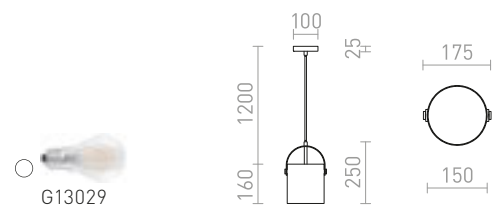

### JULIETTA 31 SUSPENSO

230 V E27 20 W

**R13753** vidro colorido opala/preto

€ 158

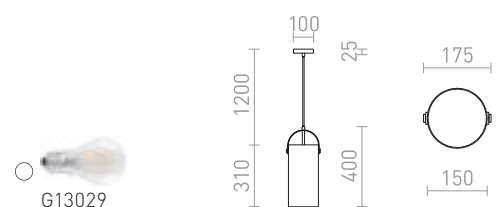





## BELLINI

Luminária suspensa de vidro com acessórios lacados para fonte de luz LED com casquilho E14.

### BELLINI L E14 SUSPENSO

230 V E14 15 W

R13658 branco/vidro transparente

€ 178

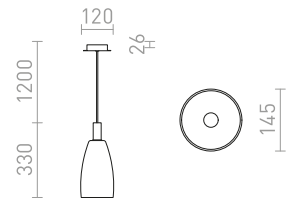

## BELLINI

Luminária LED em vidro com design suspenso. Adequado para iluminar bares e ilhas de cozinha.

### BELLINI M LED SUSPENSO

230 V LED 5 W  $\angle 30^\circ$  3000 K 475 lm Ra 80

R13652 preto/vidro de cor fumo

€ 198

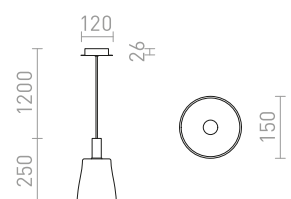



## AZRIA

Candeeiro suspenso elegante com vidro texturado e acessórios cromados.

### AZRIA SUSPENSO

230 V G9 25 W

R12056 vidro de cor fumo

€ 78 %

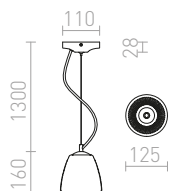

## CORONA

Luminária suspensa com vidro sólido texturado. O vidro é cromado nos dois lados. Quando acesa, a fonte de luz é parcialmente visível.

### CORONA SUSPENSO

230 V E27 42 W

R12055 vidro cromado

€ 215 %

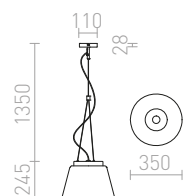



## COROA NEW 28

Luminária suspensa com abajur de vidro. Disponível em duas cores. Base de teto em cromo.

### COROA NEW 28 SUSPENSO

230 V E27 53 W

**R13824** vidro colorido opala/cromo

€ 220

**R13825** preto/cromo

€ 258

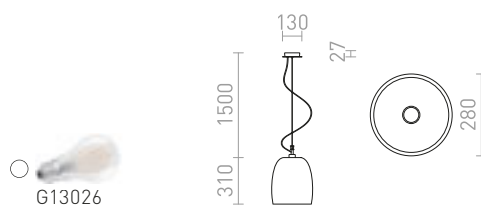

## PULIRE

Candeeiro suspenso retro feito em vidro tingido para fonte de luz com casquilho E14.

### PULIRE CON SUSPENSO

230 V E14 28 W

**R12663** vidro colorido opala/madeira/cromo

€ 98

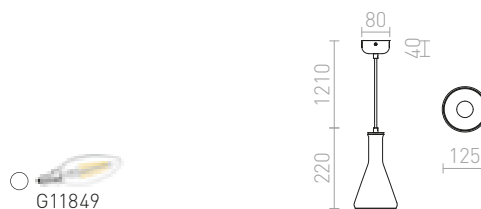

### PULIRE RD SUSPENSO

230 V E14 28 W

**R12664** vidro colorido opala/madeira/cromo

€ 98







## SANSSOUCI

Luminária suspensa com abajur de vidro. A luminária acesa é espelhada, e as fontes de luz são parcialmente visíveis quando a luz está acesa.

### SANSSOUCI I SUSPENSO

230 V E27 42 W

**R10511** vidro tingido de cobre

€ 98 →



G13111

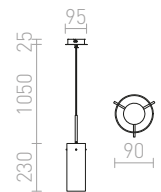

### SANSSOUCI I SUSPENSO

230 V E27 42 W

**R10509** vidro cromado

€ 98 →



G13111

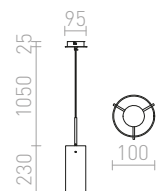



## GARNISH

Luminária suspensa com base de cromo e abajur de vidro transparente. O abajur de vidro é fechado na parte inferior e pode acolher decorações apropriadas.

### GARNISH SUSPENSO

230 V GU10 9 W

**R11756** vidro transparente/cromo

€ 138



G11837

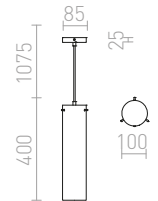

## EIGHT

Luminária suspensa com abajur de vidro opalino com detalhes cromados.

### EIGHT SUSPENSO

230 V E27 28 W

**R10493** vidro colorido opala/cromo

€ 129



G13155

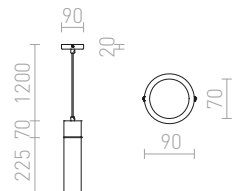

## TOMBA

Luminária cilíndrica de vidro suspensa com acessórios cromados para três fontes de luz fluorescentes lineares.

### TOMBA SUSPENSO

230 V G5 3x21 W

**R10501** vidro colorido opala/cromo

€ 278

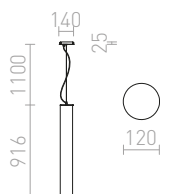
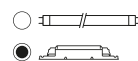





## GIFT

Luminária suspensa com um abajur de vidro texturado transparente com acessórios cromados.

### GIFT I SUSPENSO

230 V E14 42 W

**R10510** vidro transparente/cromo

€ 88

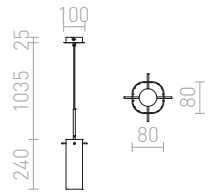

## ESTRA

Luminária LED suspensa com refletores decorativos de alumínio, cercados com um abajur de vidro transparente.

### ESTRA V SUSPENSO

230 V LED 5x5 W 3000 K 2000 lm Ra 81

**R11678** branco/vidro transparente

€ 335

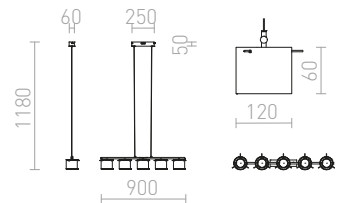
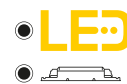

### ESTRA I SUSPENSO

230 V LED 5 W 3000 K 400 lm Ra 81

**R11679** branco/vidro transparente

€ 78

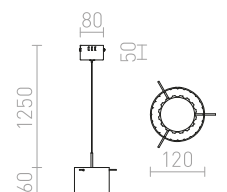





## LIZ NEW

Luminária suspensa com abajur de vidro disponível em duas cores.

### LIZ NEW SUSPENSO

230 V E27 28 W

**R13822** vidro colorido opala/cromo € 98

**R13823** preto/cromo € 98

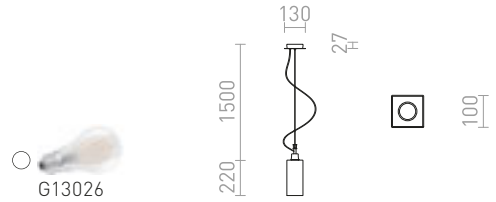

## LIZ NEW

Um candeeiro linear suspenso com abajures de vidro para fontes de luz LED E27. Adequado para ser colocado por cima de uma mesa de jantar.

### LIZ III 60 SUSPENSO

230 V LED E27 3x11 W

**R14023** vidro colorido opala/níquel mate € 150 **NEW**

**R14024** vidro colorido opala/cromo € 150 **NEW**

**R14025** preto/vidro/níquel mate € 158 **NEW**

**R14026** preto/vidro/cromo € 158 **NEW**

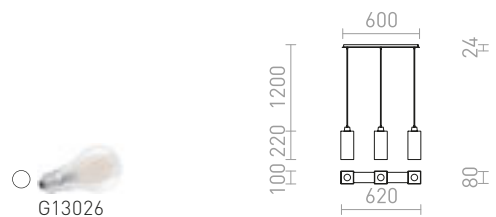

### LIZ III 80 SUSPENSO

230 V LED E27 3x11 W

**R14027** vidro colorido opala/níquel mate € 178 **NEW**

**R14028** vidro colorido opala/cromo € 178 **NEW**

**R14029** preto/vidro/níquel mate € 178 **NEW**

**R14030** preto/vidro/cromo € 178 **NEW**

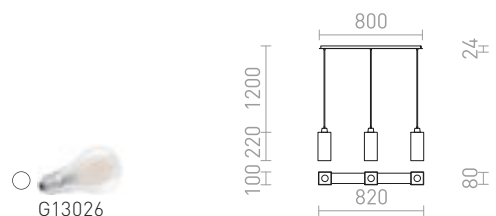

**DADOS NEW**

Luminária suspensa com abajur de vidro opala. Base de teto em cromo.

**DADOS NEW SUSPENSO**

230 V E27 28 W

**R13821** vidro colorido opala/cromo

**€ 98**

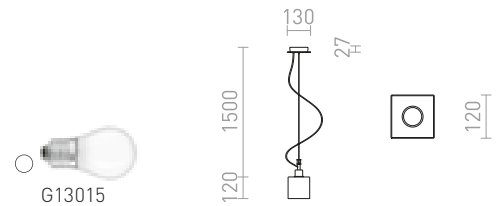
**DADOS NEW**

Um candeeiro linear suspenso com abajures de vidro para fontes de luz LED E27. Adequado para ser colocado por cima de uma mesa de jantar.

**DADOS III 60 SUSPENSO**

230 V LED E27 3x11 W

**R14019** vidro colorido opala/níquel mate

**€ 150** NEW

**R14020** vidro colorido opala/cromo

**€ 150** NEW

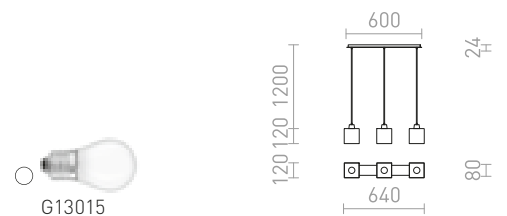
**DADOS III 80 SUSPENSO**

230 V LED E27 3x11 W

**R14021** vidro colorido opala/níquel mate

**€ 178** NEW

**R14022** vidro colorido opala/cromo

**€ 178** NEW

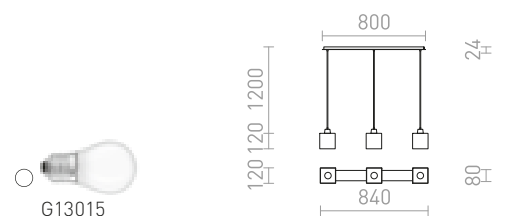



## BROADWAY

Luminária suspensa com altura ajustável. Adequada para tetos sem tomadas. Com abajur têxtil estruturado. O interruptor está localizado no cabo de alimentação.

### BROADWAY SUSPENSO AJUSTÁVEL

230 V E27 42 W

R11989 branco/cromo

€ 178 %

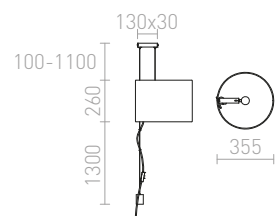



## LEVITA

Candeeiro suspenso ajustável com abajur têxtil preto ou branco.

### LEVITA SUSPENSO AJUSTÁVEL

230 V E27 42 W

**R12477** branco/cromo

€ 420

**R12478** preto/cromo

€ 420

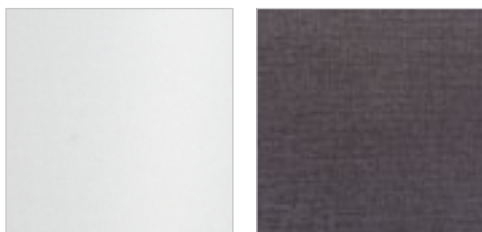

G13029

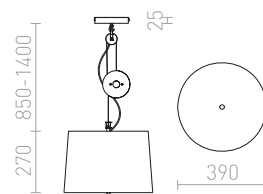



## BROADWAY

Luminária de teto com braço ajustável no eixo do teto.  
Abajur têxtil estruturado.

### BROADWAY COM BRAÇO SUSPENSO

230 V E27 42 W

R11978 branco/cromo

€ 720 %

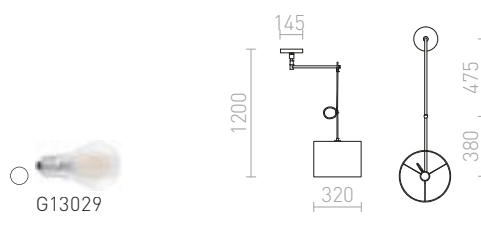
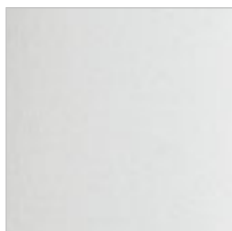

## MADISON

Luminária de teto com braço ajustável e um abajur têxtil.

### MADISON C TETO

230 V E27 42 W

R12479 branco/cromo

€ 560 ▶







## LOYD LED

Luminária de teto embutida LED com ajuste flexível multidirecional e abajur têxtil.

### LOYD LED I TETO

230 V LED 4,5W 3000 K 280 lm Ra 80

R12932 preto/níquel mate

€ 88 %

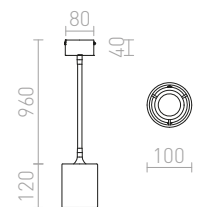



### LOYD E27 I

Luminária de teto com um braço articulado coberto por forro de silicone, ajustável em todas as direções. Para uso com fontes de luz decorativas ou refletivas E27.

#### LOYD E27 I TETO

230 V E27 28 W

R12933 cinzento bege

€ 88

R12934 preto

€ 88



G13461

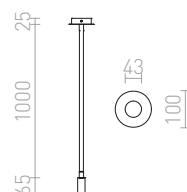

### LOYD E27 III

Luminária de teto com três braços articulados cobertos por forro de silicone, ajustáveis em todas as direções. Para uso com fontes de luz decorativas ou refletivas E27.

#### LOYD E27 III TETO

230 V E27 3x28 W

R12935 preto

€ 188



G12246

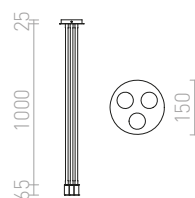







## GIULIA

Candeeiro suspenso com abajur em metal lacado e cabo têxtil.

### GIULIA 12 SUSPENSO

230 V E27 40 W

**R13908** branco/cromo

€ 58

NEW

**R13909** preto/castanho dourado/latão

€ 58

NEW



### GIULIA 20 SUSPENSO

230 V E27 40 W

**R13910** branco/cromo

€ 68

NEW

**R13911** preto/castanho dourado/latão

€ 68

NEW

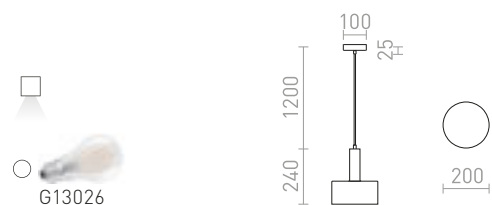

### GIULIA 40 SUSPENSO

230 V E27 40 W

**R13912** branco/cromo

€ 138

NEW

**R13913** preto/castanho dourado/latão

€ 138

NEW

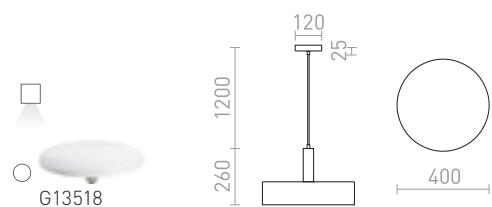



## STIG

LED elegante pendente adequada para pendurar sobre balcões de bar ou ilhas de cozinha.

### STIG SUSPENSO

230 V LED 6,8 W  $\angle 34^\circ$  3000 K 466 lm Ra 80

R13940 preto

€ 88

NEW

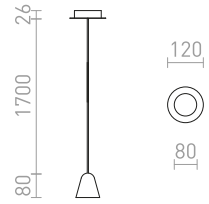
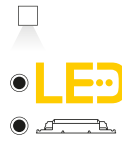

## RIGA

Luz de teto com LED integrado.

### RIGA 28 SUSPENSO

230 V LED 6 W  $\angle 38^\circ$  3000 K 570 lm Ra 80

R12458 branco

€ 98

R12459 preto

€ 98

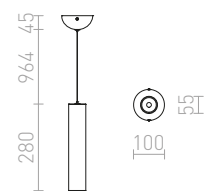
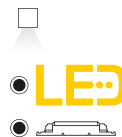

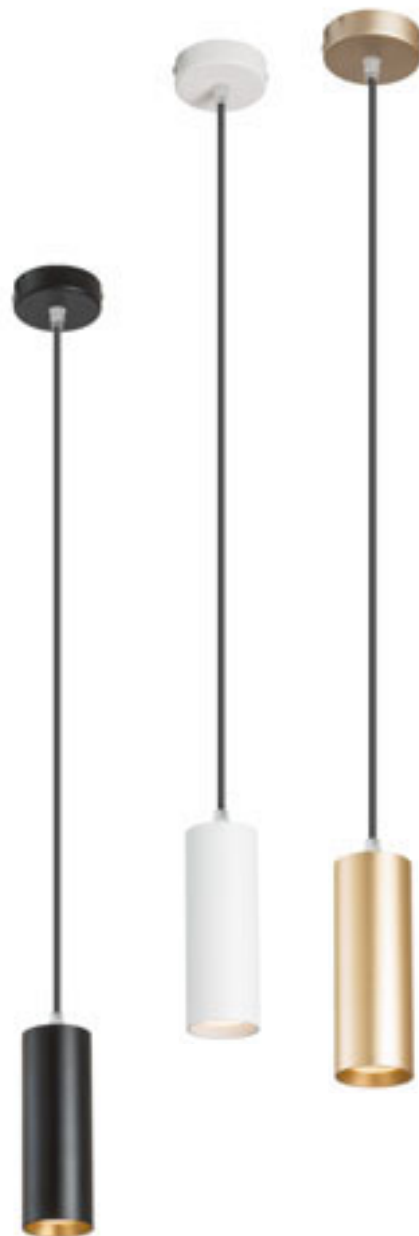

## MAVRO

Elegante foco LED suspenso cilíndrico adequado sobre balcões de bar e ilhas de cozinha. TRIAC com regulação da intensidade da luz.

### MAVRO DIMM SUSPENSO

230 V LED 12 W  $\angle 38^\circ$  3000 K 1020 lm Ra 80

**R13182** branco

€ 178

**R13183** ouro

€ 178

**R13184** preto/ouro

€ 178



## MAVRO

Elegante foco LED tubular suspenso adequado sobre balcões de bar e ilhas de cozinha.

### MAVRO SUSPENSO

230 V LED 12 W  $\angle 38^\circ$  3000 K 1020 lm Ra 80

**R12990** branco

€ 120

**R12991** ouro

€ 120

**R12992** preto/ouro

€ 120

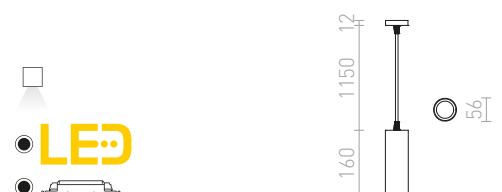



## BOGARD

Luminária LED cilíndrica suspensa. A luminária pode ser ampliada óticamente usando R12495 e R12496.

### BOGARD SUSPENSO

230 V LED 5 W  $\angle 40^\circ$  3000 K 350 lm Ra 80

R12493 mate preto

€ 98

R12494 níquel mate

€ 78

%

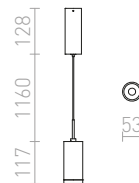
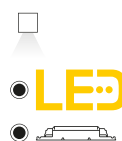

## BOGARD

Acessório para focos suspensos Bogard R12493 e R12494.

### BOGARD

#### EXTENSOR PARA SUSPENSO

R12495 mate preto

€ 13.50

R12496 níquel mate

€ 13.50

%

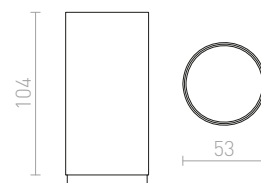

## BELENOS

Foco suspenso cilíndrico minimalista para fontes de luz GU10 sobre base redonda. As molas ligadas ao casquilho permitem o uso de fontes de luz de vários comprimentos.

### BELENOS SUSPENSO

230 V LED GU10 9 W

R13365 branco

€ 58

R13366 preto

€ 58

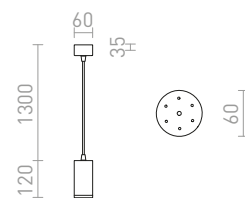
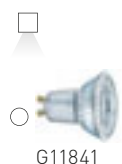



## OPTIMUS

Luminária cilíndrica suspensa com possibilidade de ajuste do cone de luz mediante sistema de zoom de 10-50°. A luminária é adequada para fontes de luz LED com casquilho GU10. Use fontes de luz com um ângulo de feixe de 120° na luminária para evitar sombras indesejadas.

### OPTIMUS SUSPENSO

230 V LED GU10 9 W  $\angle$ 10-50°

**R13777** branco

€ 58

**R13778** preto

€ 58



G12232

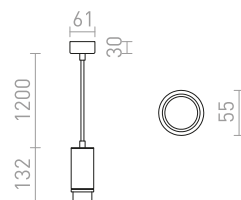



## AGNETA

Luminária suspensa redonda de metal para uso com uma fonte de luz E27 adequada.

### AGNETA SUSPENSO

230 V E27 40 W

R13897 branco

€ 58 NEW

R13898 preto

€ 58 NEW

R13899 latão escovado

€ 88 NEW

R13900 cobre escovado

€ 88 NEW

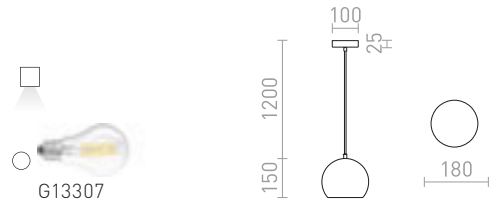

## ARAQ

Luminária suspensa com casquilho em latão, cabo têxtil e base lacada a preto. Para uso com uma fonte de luz decorativa E27 adequada.

### ARAQ SUSPENSO

230 V E27 42 W

R13891 latão escovado/preto

€ 35 NEW

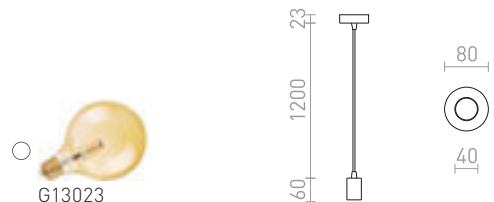

## DESTY

Luminária suspensa com abajur e base de teto em cromo ou cobre. A versão cromada vem com um cabo têxtil preto. A versão cobre tem um cabo têxtil vermelho.

### DESTY | SUSPENSO

230 V GU10 35 W

R12085 vermelho/cobre

€ 78 →

R12086 preto/cromo

€ 78 →

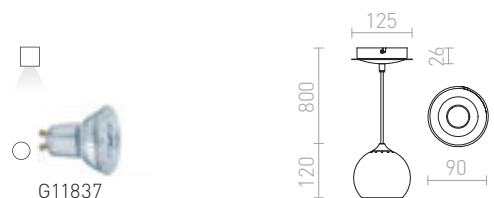



## COPA

Luminária suspensa com abajur de vidro disponível em duas cores.

### COPA SUSPENSO

230 V E27 28 W

**R11823** vidro colorido opala

€ 178

**R11824** preto/vidro

€ 178

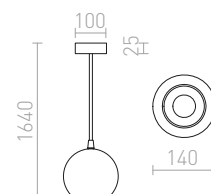





## ASTON

Candeeiro suspenso de metal com cabo transparente, para fonte de luz com casquilho E27.

### ASTON 28 SUSPENSO

230 V E27 42 W

R10515 alumínio escovado

€ 68 %

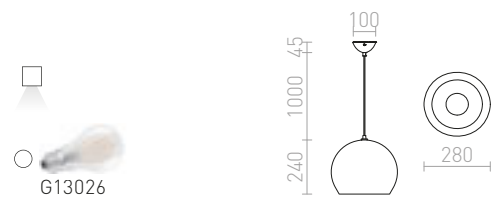

### ASTON 30 SUSPENSO

230 V E27 42 W

R12394 cromo

€ 98 %

R12395 cobre

€ 120 %

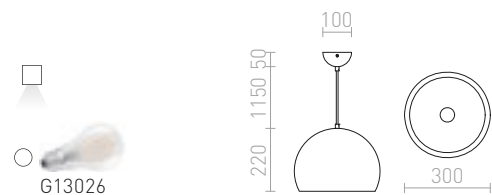



## MARGO

Luminária suspensa em cromo com fonte de alimentação LED integrada, dispersada por difusor de acrílico fosco. O difusor é moldado por um anel de alumínio.

### MARGO SUSPENSO

230 V LED 7 W 3000 K 700 lm Ra 80

R10578 cromo

€ 48 %

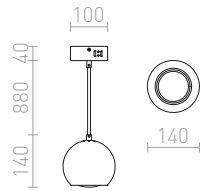

## BLONDIE

Candeeiro suspenso com abajur metálico texturado. O exterior do abajur é em cobre, o interior é lacado a branco. Inclui cabo de PVC preto e copo de cobre.

### BLONDIE 25 SUSPENSO

230 V E27 42 W

R12057 cobre

€ 198



G13461

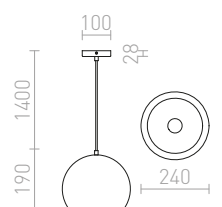





## SINTRA

Candeeiro suspenso com abajur de metal cromado, disponível em dois tamanhos.

### SINTRA 30 SUSPENSO

230 V E27 42 W

R11698 cromo

€ 58 %

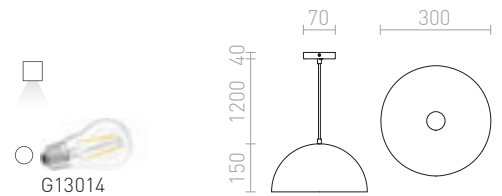

### SINTRA 40 SUSPENSO

230 V E27 42 W

R11699 cromo

€ 120 %

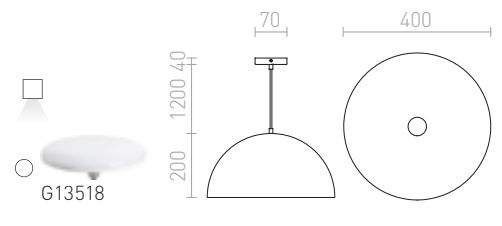

## MONROE

Luminária suspenso com abajur metálico, disponível em dois tamanhos.

### MONROE 30 SUSPENSO

230 V E27 42 W

R11700 mate preto/branco

€ 150

R12396 cobre

€ 120 %

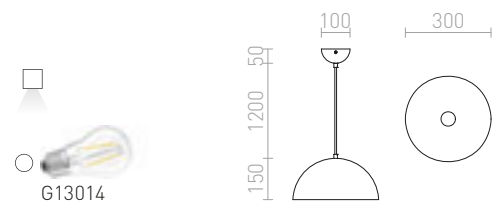

### MONROE 40 SUSPENSO

230 V E27 42 W

R11701 mate preto/branco

€ 215

R11707 branco brilhante/branco

€ 215

R12397 cobre

€ 150 %

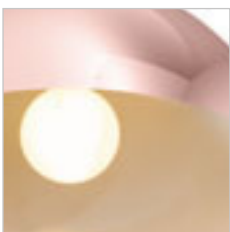
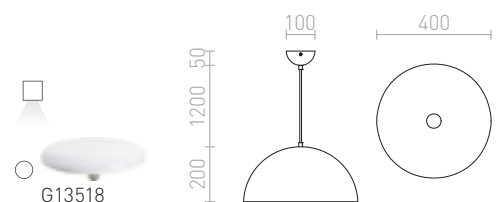



## CARISSIMA

Candeeiro suspenso com abajur de metal lacado ou cromado. A parte interior do abajur tem um design dourado ou cinza prateado.

### CARISSIMA 25 SUSPENSO

230 V E27 28 W

R11765 cromo

€ 58

%



### CARISSIMA 40 SUSPENSO

230 V E27 42 W

R11766 mate preto/ouro

€ 220

R13048 mate branco/cinza prata

€ 220

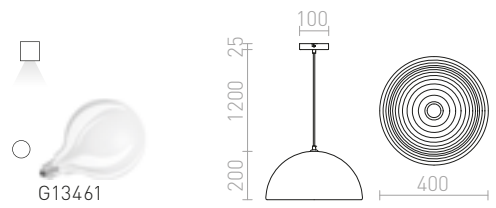

## BABADES

Luminária suspensa com abajur e base de teto em cromo ou níquel mate. Inclui um cabo têxtil preto.

### BABADES IV SUSPENSO

230 V GU10 4x35 W

R12083 cromo

€ 215

R12084 níquel mate

€ 215

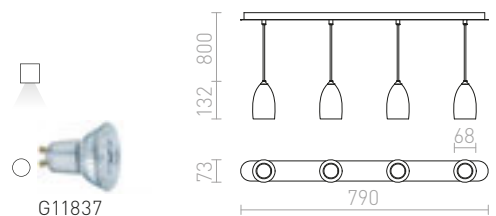

### BABADES I SUSPENSO

230 V GU10 35 W

R12081 cromo

€ 58

R12082 níquel mate

€ 58

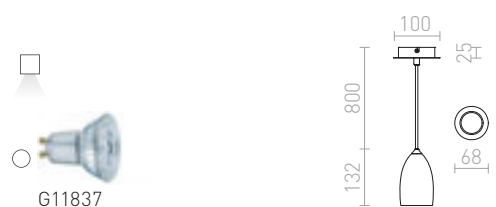







## GOLDIE

Luminária de metal suspensa, disponível em três cores.

### GOLDIE 36 SUSPENSO

230 V E27 42 W

**R11687** cromo

€ 120 %

**R11688** preto/branco

€ 178

**R11689** branco/branco

€ 88 %

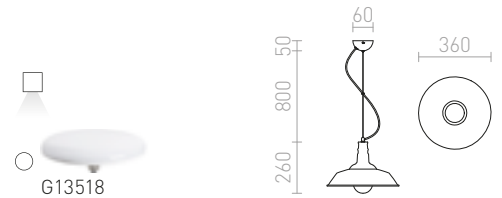

### GOLDIE 46 SUSPENSO

230 V E27 42 W

**R11690** preto/branco

€ 220

**R11691** branco/branco

€ 215

**R11692** cromo

€ 158 %

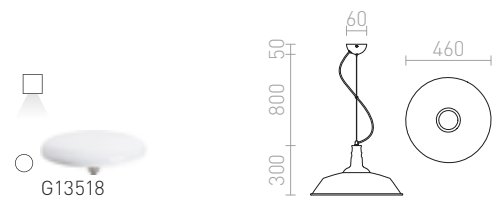

## MERYLYN

Luminária suspensa cônica de metal para casquilho E27.

### MERYLYN 48 SUSPENSO

230 V E27 42 W

**R12446** alumínio penteado/laca dourada

€ 150 ↗

**R12447** preto/branco

€ 150 ↗

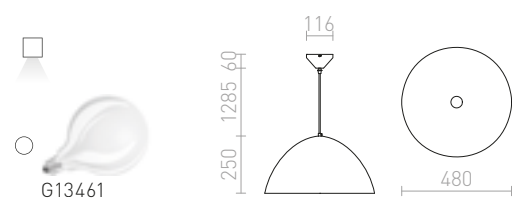





## MEZZO

Plafon de teto com fonte de luz LED embutida e moldura de alumínio lacada. O equipamento é fornecido com um difusor de luz em policarbonato fosco. Com o kit de suspensão (R13330 ou R13331), o plafon pode ser instalado como suspenso. Regulação da intensidade da luz TRIAC.

### MEZZO 80 DIMM TETO

230 V LED 100 W 3000 K 6400 lm Ra 80

R13334 branco

€ 850

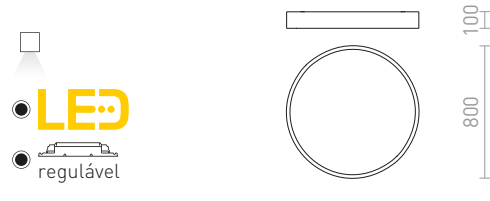

## MEZZO

Conjunto suspenso adequado para a série MEZZO.

### MEZZO 80 CONJUNTO SUSPENSO

230 V

R13335 branco

€ 120

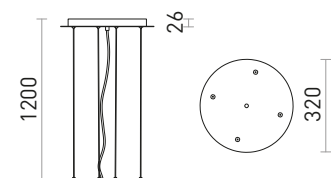



## MEZZO

Plafon de teto com fonte de luz LED embutida e moldura de alumínio lacada. O equipamento é fornecido com um difusor de luz em policarbonato fosco. Com o kit de suspensão (R13330 ou R13331), o plafon pode ser instalado como suspenso. Regulação da intensidade da luz TRIAC.

### MEZZO 40 DIMM TETO

230 V LED 30 W 3000 K 1800 lm Ra 80

R13328 branco

€ 258

R13329 preto

€ 258

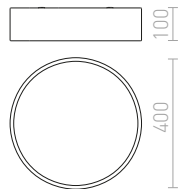
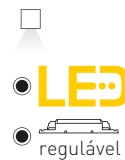

### MEZZO 60 DIMM TETO

230 V LED 60 W 3000 K 3700 lm Ra 80

R13332 branco

€ 480

R13333 preto

€ 480

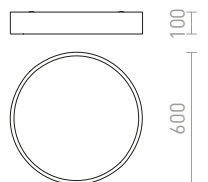
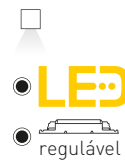

## MEZZO

Conjunto suspenso adequado para a série MEZZO.

### MEZZO 40/60 CONJUNTO SUSPENSO

230 V

R13330 branco

€ 58

R13331 preto

€ 58

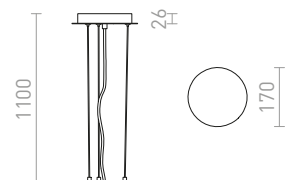



## ASTERI

Luminária suspensa com abajur de vidro acetinado. A cobertura inferior é fixada com placa redonda cromada.

### ASTERI SUSPENSO

230 V 2GX13 40 W

R10626 vidro acetinado/cromo

€ 88 %

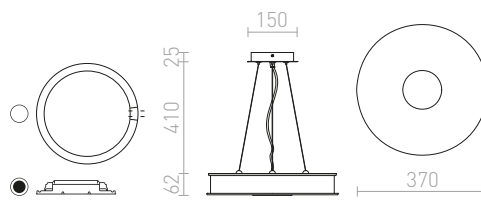

## CASSABLANCA

Luminária para duas fontes de luz fluorescentes circulares T5. A cobertura inferior de vidro acetinado é fixada com parafuso de cabeça cromada. A lateral da luminária é feita de acrílato.

### CASSABLANCA 40 SUSPENSO

230 V 2GX13 + 2GX13 22 W + 40 W

R10522 cromo

€ 120 %

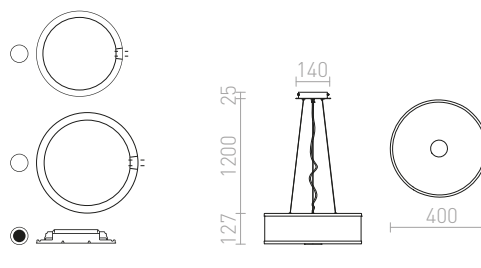

## LARISA

Plafon suspenso com LED e moldura minimalista.

### LARISA R 30 SUSPENSO

230 V LED 30 W 3000 K 2400 lm Ra 80

R12846 branco

€ 98 %

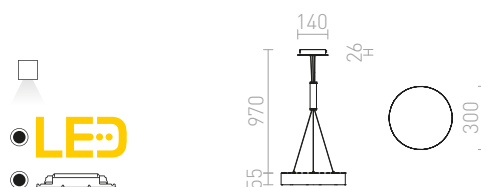



## MONETA

Luminária LED suspensa com um design muito elegante. Inclui um difusor de policarbonato fosco. Regulação da intensidade da luz TRIAC.

### MONETA DIMM SUSPENSO

230 V LED 36 W 3000 K 2500 lm Ra 80

R10581 branco

€ 290

%

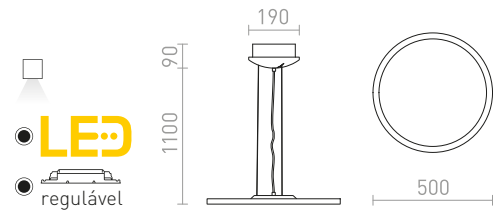



## MESA

Luminária LED suspensa com moldura em alumínio lacado ou escovado. Inclui um difusor de acrílico fosco.

### MESA SQ 48 SUSPENSO

230 V LED 56 W 3000 K 3530 lm Ra 80

R11291 branco

€ 178 %

R11292 alumínio escovado

€ 178 %

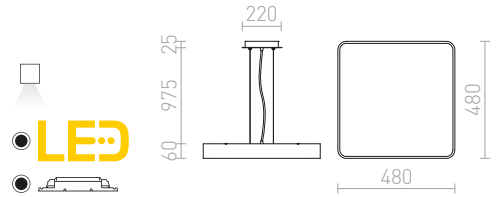



## MENSA

Luminária LED suspensa com moldura de alumínio lacada a branco. Inclui difusor em acrílico fosco.

### MENSA RC SUSPENSO

230 V LED 36 W 3000 K 2300 lm Ra 80

R10584 branco

€ 150 %

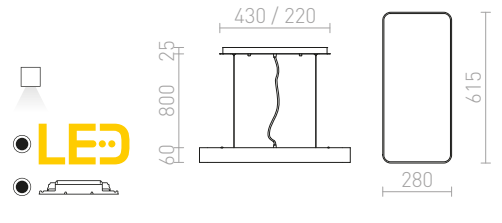

## LARISA

Plafon suspensó LED quadrado com moldura minimalista.

### LARISA SQ 30 SUSPENSO

230 V LED 30 W 3000 K 2400 lm Ra 80

R12852 branco

€ 88 %

R12853 preto

€ 88 %

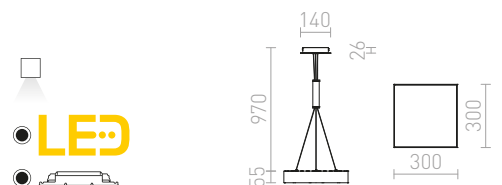





## STRUCTURAL

Luminária suspensa LED em perfil de alumínio, design elegante em alumínio natural ou lacado a branco com difusor PMMA opalino com luz embutida, cabo transparente de três núcleos.

### STRUCTURAL LED 20x20 SUSPENSO

230 V LED 12 W 3000 K 900 lm Ra 80

R13709 alumínio escovado

€ 158 ➔

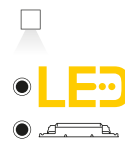
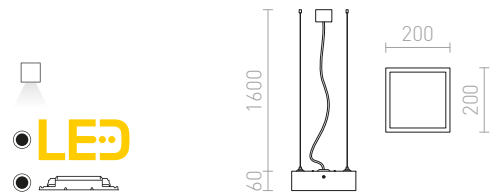

### STRUCTURAL LED 40x40 SUSPENSO

230 V LED 36 W 3000 K 2600 lm Ra 80

R13710 branco

€ 290 ➔

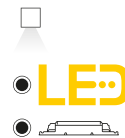
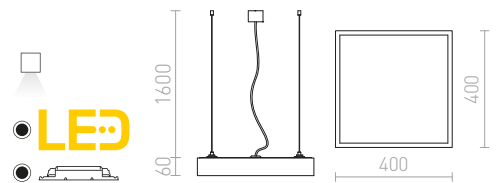

### STRUCTURAL LED 55x55 SUSPENSO

230 V LED 48 W 3000 K 3600 lm Ra 80

R13713 branco

€ 178 %

R13714 alumínio escovado

€ 258 %

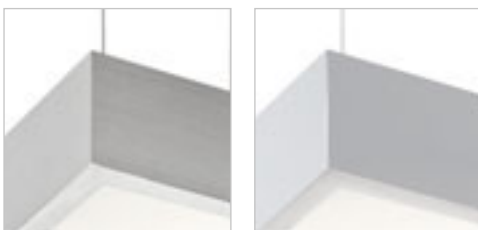
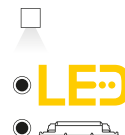
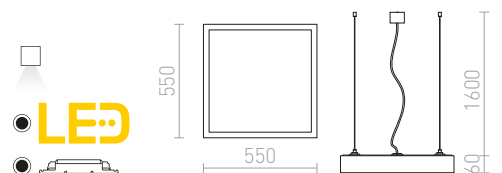







## PESANTE

Luminária suspensa linear com LED integrado adequada para interiores modernos.

### PESANTE 35 SUSPENSO

230 V LED 40 W 3000 K 3340 lm Ra 80

**R12718** alumínio anodizado

€ 220

**R12719** preto

€ 229

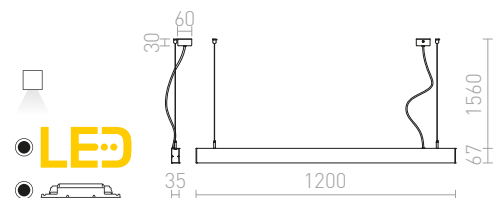

### PESANTE 75 SUSPENSO

230 V LED 40 W 3000 K 4200 lm Ra 80

**R12720** alumínio anodizado

€ 290

**R12721** preto

€ 320

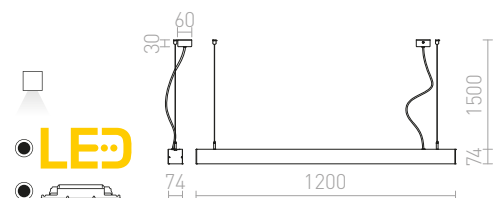



IP65

### TRIDENT PRO

Luminária industrial linear LED para montagem em teto ou suspenso com kit G13672. Alto desempenho e proteção IP65. Fornecido sem kit de suspensão e cabo de alimentação. Possibilidade de ligação entre luminárias em série.

#### TRIDENT PRO 120 CORPO

230 V LED 40 W 4000 K 5200 lm Ra 80 IP65

G13670 cinzento/acrílico fosco

€ 58

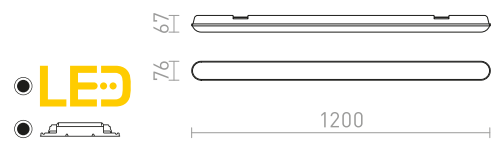

#### TRIDENT PRO 150 CORPO

230 V LED 60 W 4000 K 7800 lm Ra 80 IP65

G13671 cinzento/acrílico fosco

€ 88

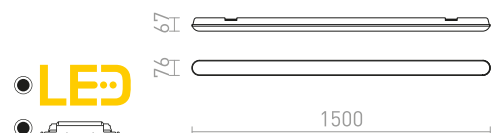



## TRIDENT PRO

Conjunto para pendurar luminárias Trident.

TRIDENT PRO CONJUNTO SUSPENSO 2 PÇS

613672 preto

€ 3.50

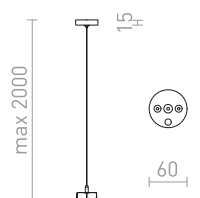

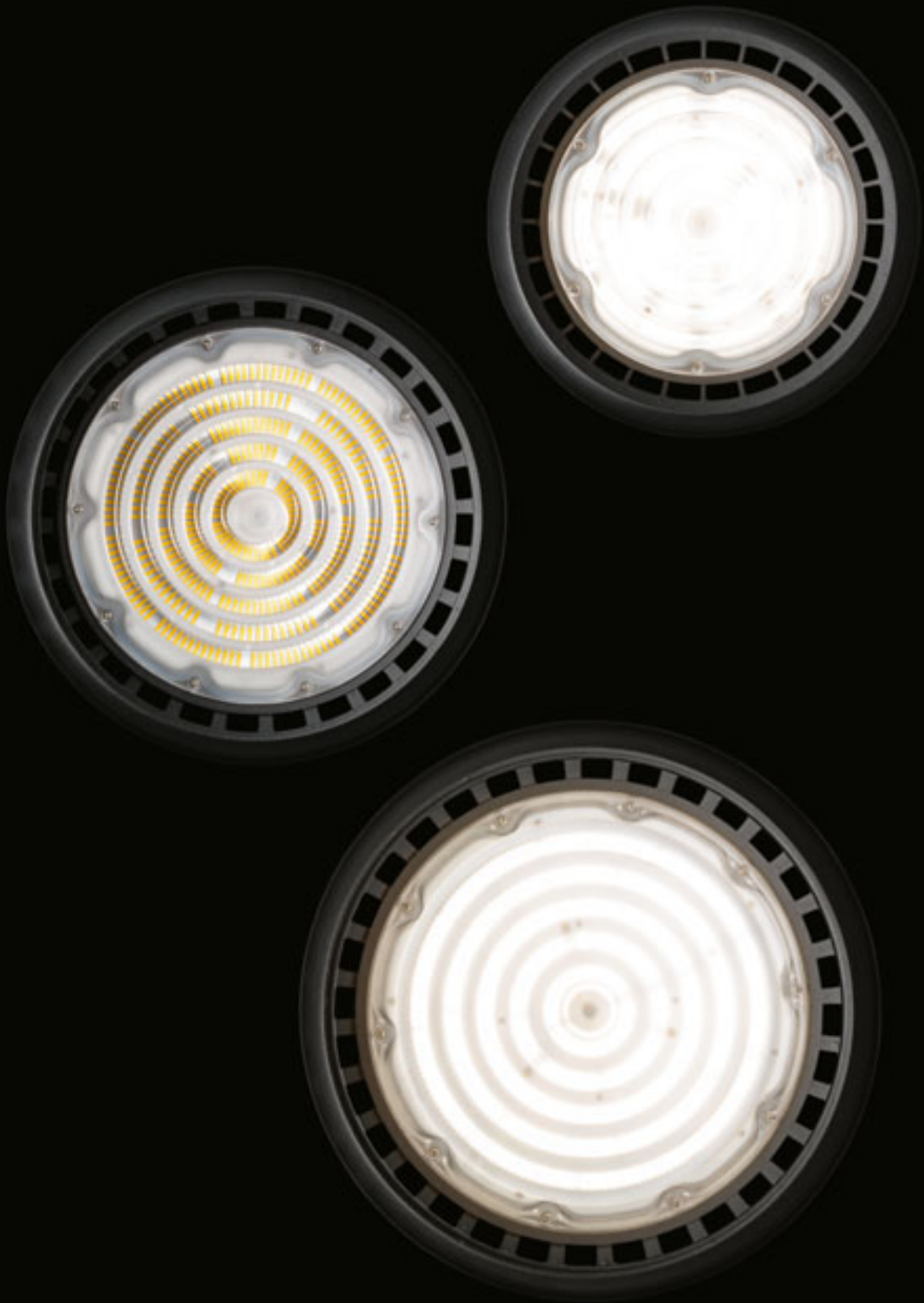



IP65

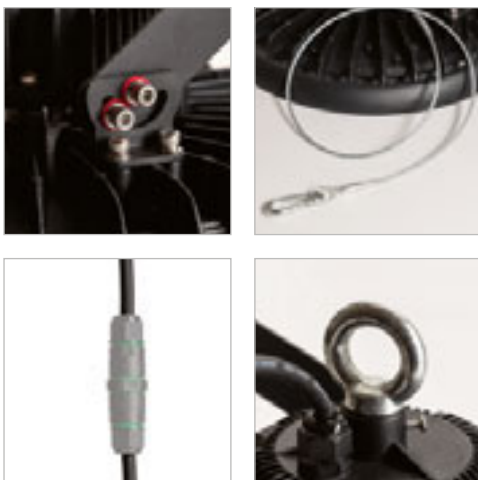

### MEGALOS PRO

Refletor industrial LED de alta potência para suspensão. Fornecido com cabo de segurança (0,5 m), olhal de suspensão e cabo de alimentação com 0,2 m de comprimento. Recomendamos o uso de IP BOX G12984 para ligar ao seu cabo de alimentação.

#### MEGALOS PRO 26 CORPO

230 V LED 100 W  $\angle 90^\circ$  4000 K 16000 lm Ra 80 IP65

G13749 preto

€ 88

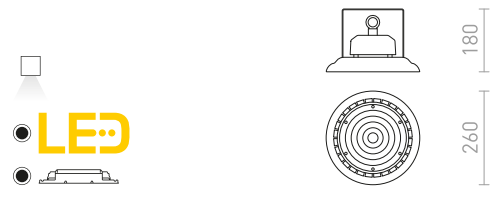

#### MEGALOS PRO 30 CORPO

230 V LED 150 W  $\angle 90^\circ$  4000 K 24000 lm Ra 80 IP65

G13750 preto

€ 120

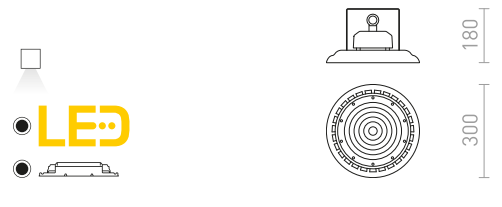

#### MEGALOS PRO 35 CORPO

230 V LED 200 W  $\angle 90^\circ$  4000 K 32000 lm Ra 80 IP65

G13751 preto

€ 138





## CANDEEIROS DE TETO

CASA DE BANHO	96-115
GESSO	116-121
DECORATIVO	122-125
DESCENDENTE	126-143
CIRCULAR	144-155
ANGULAR	156-167
TÉCNICO	168-173
OBLONGO	174-175



# CANDEEIROS DE TETO

## CASA DE BANHO



**GRANDE LED 25**  
96-97



**GRANDE LED 35**  
96-97



**CIRA LED 23**  
98-99

96-115



**CIRA LED 35**  
98-99



**GORRA**  
100-101



**BARRY**  
100-101



**AWE 23**  
100-101



**AWE 33**  
100-101



**ZARA LED 26**  
102-103



**SARA LED 26**  
102-103



**SARA LED 36**  
102-103



**SASSARI**  
102-103



**VENICE 23**  
104-105



**VENICE LED 30**  
104-105



**ARANA R 17**  
104-105



**ARANA R 27**  
104-105



**BOLLY 17**  
106-107



**BOLLY 26**  
106-107



**MERINGUE 11**  
106-107



**MERINGUE 16**  
106-107



**ESICA CYL**  
108-109



**EIGHT**  
108-109



**ESICA SQ**  
108-109



**LOLA 88**  
110-111



**SAMMY**  
110-111



**EILEEN**  
110-111



**KIM**  
110-111



**ORIN R**  
112-113



**MERIDO**  
112-113



**DEZA**  
112-113



**ORIN SQ**  
112-113



**MERANO LED 30**  
114-115



**MERANO LED 35**  
114-115



**SPECTACLE**  
114-115



**BONO**  
114-115

## CANDEEIROS DE TETO GESSO



**GINA S 17**  
116-117



**GINA**  
116-117



**GINA III**  
116-117

116-121



**COLIN**  
116-117



**JACK SQ**  
118-119



**JACK SQ S 17**  
118-119



**JACK III**  
118-119



**COLES**  
120-121



**COLES SQ**  
120-121



**VOLCA**  
120-121

## CANDEEIROS DE TETO DECORATIVO



**TACO**  
122-123



**OTIS 60**  
122-123



**SOLARIS**  
122-123

122-125



**VENICE 23**  
124-125



**VENICE LED 30**  
124-125



**MARA**  
124-125

## CANDEEIROS DE TETO DESCENDENTE

126-143



**BOGARD TWIN**  
126-127



**BELENOS**  
126-127



**BOGARD**  
126-127



**CONDU**  
126-127



**SNAZZY**  
128-129



**PIXIE**  
128-129



**DARIO**  
128-129



**DARIO**  
128-129



**PIXIE**  
128-129



**RIGA 38**  
130-131



**RIGA 18**  
130-131



**CONNOR**  
130-131



**KELLY LED**  
130-131



**VADE R**  
132-133



**TUBA**  
132-133



**CANTO**  
132-133



**MOMA**  
134-135



**MOMA**  
134-135



**MOCCA**  
134-135



**MAYO R**  
134-135



**MEA**  
134-135



**MANTOVA I**  
136-137



**MANTOVA II**  
136-137



**GAYA**  
136-137



**MILANO I**  
136-137



**MILANO II**  
136-137



**ENKI EDG I**  
138-139



**ENKI EDG II**  
138-139



**AGATE I**  
138-139



**AGATE II**  
138-139



**BERIT I**  
140-141



**BERIT II**  
140-141



**MAYO SQ**  
140-141



**JAMES I**  
140-141



**JAMES II**  
140-141



**MARVEL**  
142-143



**MARVEL II**  
142-143



**MARVEL II**  
142-143

## CANDEEIROS DE TETO CIRCULAR



**MEZZO 40**  
144-145



**MEZZO 60**  
144-145



**MEZZO 80**  
144-145

144-155



**LARISA R 12**  
146-147



**LARISA R 22**  
146-147



**LARISA R 30**  
146-147



**LARISA R 40**  
146-147



**LARISA R 12**  
148-149



**LARISA R 22**  
148-149



**LARISA R 30**  
148-149



**HUE R 9**  
150-151



**HUE R 17**  
150-151



**HUE R 22**  
150-151



**HUE R 9**  
152-153



**HUE R 17**  
152-153



**HUE R 22**  
152-153



**MENSA R 80**  
154-155



**ALLEGRO II 43**  
154-155

## CANDEEIROS DE TETO ANGULAR



**LARISA SQ 17**  
156-157



**LARISA SQ 22**  
156-157



**LARISA SQ 30**  
156-157

156-167



**LARISA SQ 40**  
156-157



**LARISA SQ 17**  
158-159



**LARISA SQ 22**  
158-159



**LARISA SQ 30**  
158-159



**MENSA SQ 40**  
160-161



**MENSA SQ 48**  
160-161



**MENSA SQ 80**  
160-161



**STRUCTURAL LED 20x20**  
162-163



**STRUCTURAL LED 40x40**  
162-163



**STRUCTURAL LED 55x55**  
162-163



**HUE SQ 9**  
164-165



**HUE SQ 17**  
164-165



**HUE SQ 22**  
164-165



**HUE SQ 9**  
166-167



**HUE SQ 17**  
166-167



**HUE SQ 22**  
166-167

## CANDEEIROS DE TETO TÉCNICO

168-173



**SOCORRO R 300**  
168-169



**SLENDER R 12**  
168-169



**SLENDER SQ 12**  
168-169



**SLENDER SQ 22**  
168-169



**SEMPRE SQ 63**  
170-171



**SEMPRE R 55**  
170-171



**MELISA 25**  
170-171



**MELISA 52**  
170-171



**SEMPRE SQ 33**  
172-173



**SEMPRE SQ 43**  
172-173



**SEMPRE SQ 53**  
172-173



**SEMPRE SQ 63**  
172-173

## CANDEEIROS DE TETO OBLONGO

174-175



**STRUCTURAL LED 60x15**  
174-175



**TRIDENT PRO 120**  
174-175



**TRIDENT PRO 150**  
174-175



IP44



IP44



## GRANDE

Plafon de LED para casa de banho com vidro plano opalino em estrutura de metal.

### GRANDE LED 25 TETO

230 V LED 12 W 3000 K 900 lm Ra 80 IP44

R13676 vidro colorido opala/cromo

€ 178

R13677 vidro colorido opala/preto

€ 158

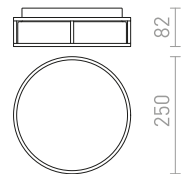

### GRANDE LED 35 TETO

230 V LED 24 W 3000 K 1700 lm Ra 80 IP44

R13678 vidro colorido opala/cromo

€ 290

R13679 vidro colorido opala/preto

€ 268

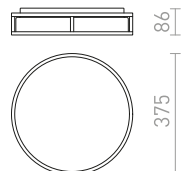







IP44



IP44

## CIRA

Plafon LED com vidro plano opalino em estrutura de metal. Adequado para ambientes húmidos.

### CIRA LED 23 TETO

230 V LED 12 W 3000 K 900 lm Ra 80 IP44

R13680 vidro colorido opala/preto

€ 120

R13742 vidro colorido opala/cromo

€ 150



### CIRA LED 35 TETO

230 V LED 24 W 3000 K 1700 lm Ra 80 IP44

R13681 vidro colorido opala/cromo

€ 258

R13754 vidro colorido opala/preto

€ 248







IP44

## GORRA

Plafon para ambientes húmidos. O vidro opalino tem as seguintes dimensões Ø / A 24/3 cm.

### GORRA TETO

230 V E14 2x40 W IP44

R10500 cromo

€ 88 %

R12048 níquel mate

€ 88 %



G11849

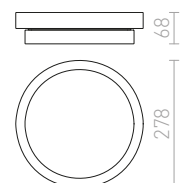



IP44



IP44



IP44



IP44

### BARRY

Plafon circular com moldura de níquel mate para fonte de luz fluorescente circular com eficiência energética.

#### BARRY TETO

230 V 2GX13 22 W IP44

R10576 níquel mate

€ 38

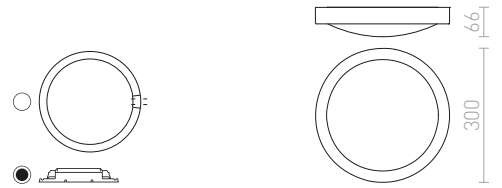

### AWE

Plafon com LED integrado e abajur de vidro opalino. A base do teto é cromada ou níquel mate. Adequado para ambientes húmidos.

#### AWE 23 TETO

230 V LED 14 W 3000 K 580 lm Ra 80 IP44

R12196 níquel mate

€ 129

R12201 cromo

€ 129

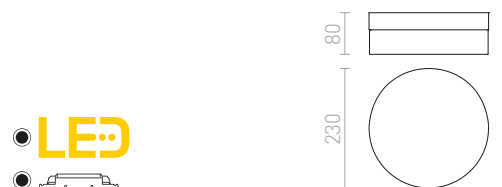

#### AWE 33 TETO

230 V LED 21 W 3000 K 948 lm Ra 80 IP44

R12197 níquel mate

€ 215

R12202 cromo

€ 215

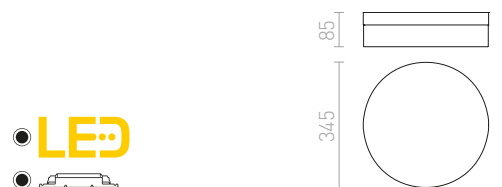



IP44

## ZARA

Plafon LED de vidro opalino com base cromada, adequado para ambientes húmidos.

### ZARA LED 26 TETO

230 V LED 12 W 3000 K 900 lm Ra 80 [IP44](#)

R13686 vidro colorido opala/cromo

€ 129

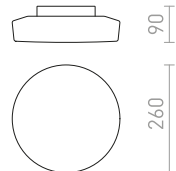

IP65

## SASSARI

Plafon LED redondo para teto de casa de banho.

### SASSARI TETO

230 V LED 24 W 3000 K 1900 lm Ra 80 IP65

R13642 branco/policarbonato/plástico

€ 120

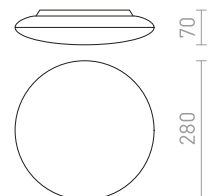



IP44



IP44

## SARA

Plafon de LED em vidro opalino com base cromada, adequado para casas de banho.

### SARA LED 26 TETO

230 V LED 12 W 3000 K 900 lm Ra 80 IP44

R13687 vidro colorido opala/cromo

€ 129

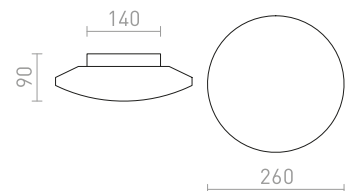

● LED



### SARA LED 36 TETO

230 V LED 24 W 3000 K 1700 lm Ra 80 IP44

R13688 vidro colorido opala/cromo

€ 229

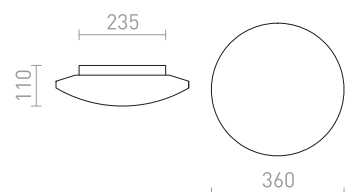

● LED





IP44

## ARANA

Cilindro de teto em vidro opalino com base cromada, adequado para casas de banho.

### ARANA R 17 TETO

230 V E27 15 W IP44

R13682 vidro colorido opala/cromo

€ 120



G13014



160



170



IP44

**ARANA**

Cilindro de teto em vidro opalino com base cromada, adequado para casas de banho.

**ARANA R 27 TETO**

230 V E27 20 W IP44

R13683 vidro colorido opala/cromo

€ 178

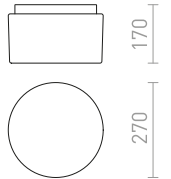

IP44

**VENICE**

Luminária de teto com um abajur combinado, composto por um vidro transparente no exterior e um vidro opalino no interior, situada sobre numa base cromada e com um casquilho E27 para fontes de luz LED. Adequado para utilização em casas de banho.

**VENICE 23 TETO**

230 V E27 20 W IP44

R13684 vidro transparente/vidro colorido opala/cromo € 198

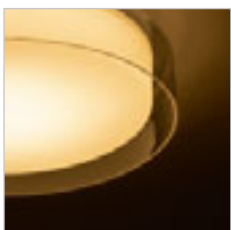
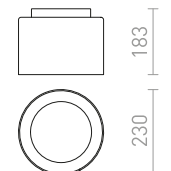

IP44

**VENICE**

Plafon LED com um abajur combinado, composto por um vidro transparente exterior e um vidro opalino interior, situado numa base cromada e com LED incorporado. Adequado para utilização em casas de banho.

**VENICE LED 30 TETO**

230 V LED 12 W 3000 K 900 lm Ra 80 IP44

R13685 vidro transparente/vidro colorido opala/cromo € 248

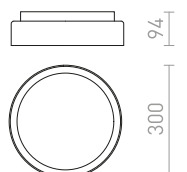







IP44



IP44



IP44

IP44



### BOLLY

Candeeiro de teto em vidro opalino com base cromada. Adequado para casas de banho.

#### BOLLY 17 TETO

230 V E27 15 W IP44

R13693 vidro colorido opala/cromo

€ 150

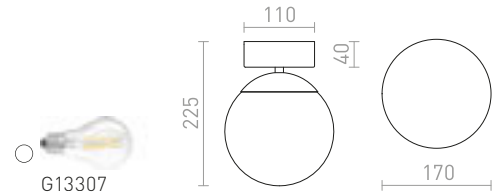

#### BOLLY 26 TETO

230 V E27 15 W IP44

R13694 vidro colorido opala/cromo

€ 178

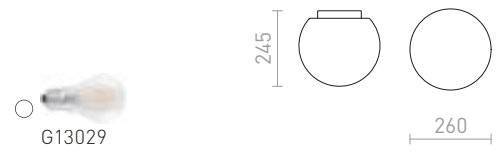

### MERINGUE

Luminária de teto oval de vidro com base cromada. Adequada para casas de banho.

#### MERINGUE 11 TETO

230 V LED G9 9 W IP44

R13689 vidro colorido opala/cromo

€ 88 %

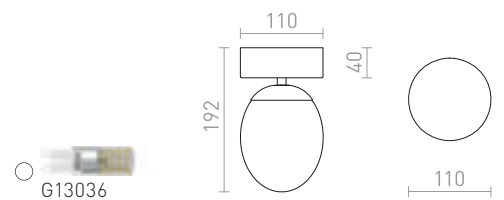

#### MERINGUE 16 TETO

230 V E27 15 W IP44

R13690 vidro colorido opala/cromo

€ 120 %

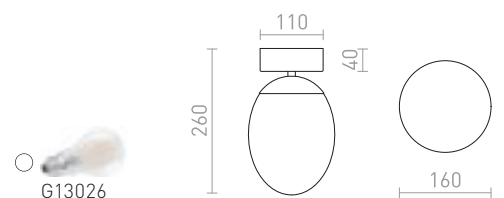



IP44

## ESICA

Candeeiro de teto cilíndrico com LED e vidro opalino. Adequado para ambientes húmidos.

### ESICA SQ TETO

230 V LED 6 W 3000 K 435 lm Ra 80 IP44

R12198 cromo

€ 78

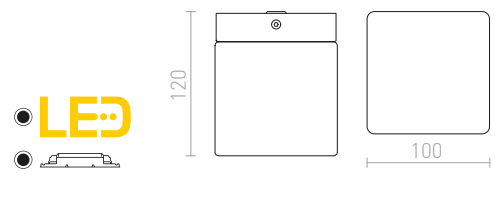

IP44

## ESICA

Candeeiro de teto cilíndrico com LED e vidro opalino. Adequado para ambientes húmidos.

### ESICA CYL TETO

230 V LED 6 W 3000 K 369 lm Ra 80 IP44

R12199 cromo

€ 78

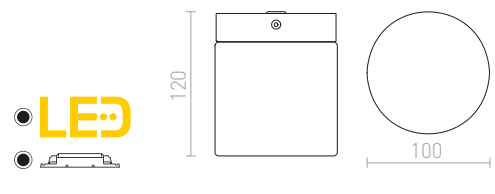

IP44

## EIGHT

Luminária de teto com abajur de vidro opalino. Adequada para ambientes húmidos.

### EIGHT TETO

230 V E27 28 W IP44

R10492 vidro colorido opala/cromo

€ 98 →

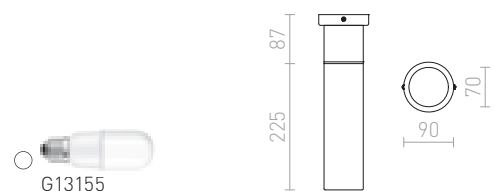





IP65

## EILEEN

Cilindro de teto adequado para uso em casas de banho, para fonte de luz LED com casquilho GU10.

### EILEEN TETO

230 V GU10 35 W IP65

R13606 branco

€ 58

R13607 preto

€ 58



G11841

117

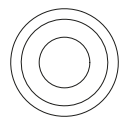
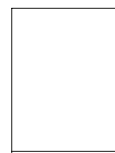

85



IP65

### KIM

Prisma de teto adequado para uso em casas de banho, para fonte de luz LED com casquilho GU10.

#### KIM TETO

230 V GU10 35 W IP65

R13608 branco

€ 58

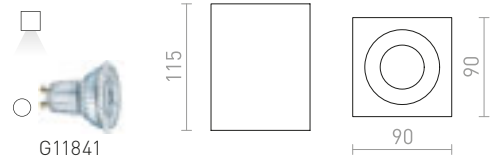

IP54

### LOLA

Foco de teto com proteção para ambientes húmidos e adequado para casa de banho.

#### LOLA 88 TETO

230 V GU10 15 W IP54

R13538 branco

€ 48

R13539 cromo

€ 48

R13542 preto

€ 48

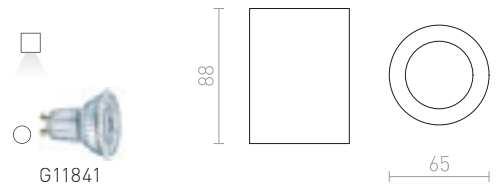

IP54

### SAMMY

Foco de exterior com casquilho GU10. Com cobertura de vidro transparente na parte inferior.

#### SAMMY TETO

230 V LED GU10 15 W IP54

R13450 branco

€ 58

R13451 cinzento

€ 48

R13452 cinzento antracite

€ 58

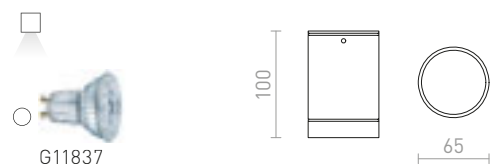



IP54

IP54

## MERIDO

Luminária de teto exterior para fontes de luz GX53 de baixo consumo energético.

### MERIDO TETO

230 V GX53 11 W IP54

R10428 branco

€ 58

R10429 cinzento prata

€ 58

R10430 cinzento antracite

€ 58

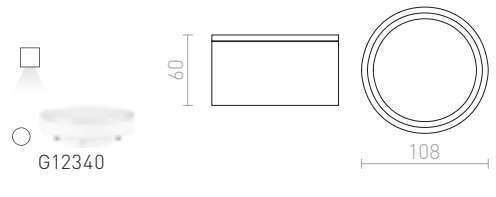

## ORIN

Iluminação de teto cilíndrica LED para exterior com abajur acetinado.

### ORIN R TETO

230 V LED 10 W 3000 K 650 lm Ra 80 IP54

R13626 branco/acrílico acetinado

€ 78

R13627 cinzento antracite/acrílico acetinado

€ 78

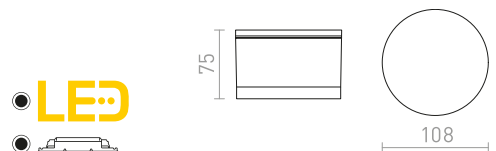



IP54



## ORIN

Iluminação LED quadrada para teto com abajur acetinado.

### ORIN SQ TETO

230 V LED 10 W 3000 K 800 lm Ra 80 IP54

**R13628** branco/acrílico acetinado

€ 78

**R13629** cinzento antracite/acrílico acetinado

€ 78

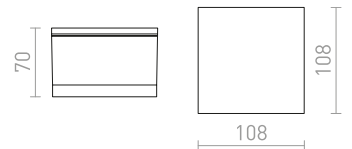

IP54

## DEZA

Luminária de teto de alumínio maciço com cobertura de vidro acetinado.

### DEZA QUADRADO

230 V G9 25 W IP54

**R10166** alumínio/vidro acetinado

€ 48

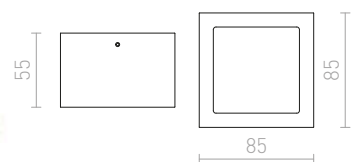



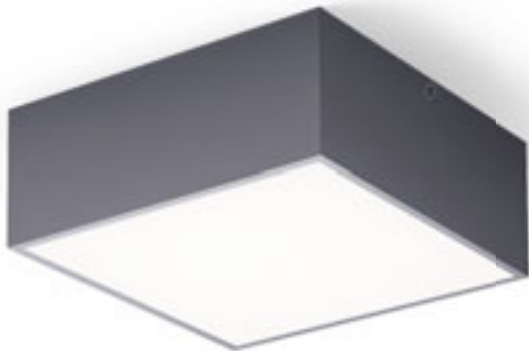

IP65

## BONO

Luz externa de alumínio fundido com LED integrado e um difusor de cor opala. Para montagem no teto ou na parede.

### BONO SUPERFÍCIE

230 V LED 4 W 3000 K 297 lm Ra 80 IP65

R11967 cinzento antracite

€ 150

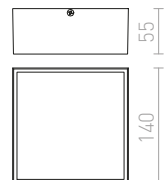
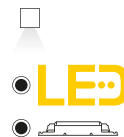



IP54

**SPECTACLE**

Luz externa de alumínio fundido com LED integrado e um difusor de cor opala. Para montagem em teto ou parede.

**SPECTACLE SUPERFÍCIE**

230 V LED 5 W 3000 K 350 lm Ra 80 IP54

R11968 cinzento prata

€ 78

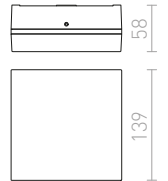
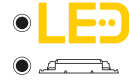

IP44

**MERANO**

Plafon de LED quadrado adequado para ambientes húmidos.

**MERANO LED 30 TETO**

230 V LED 16 W 3000 K 1300 lm Ra 80 IP44

R13697 cromo/acrílico fosco

€ 178

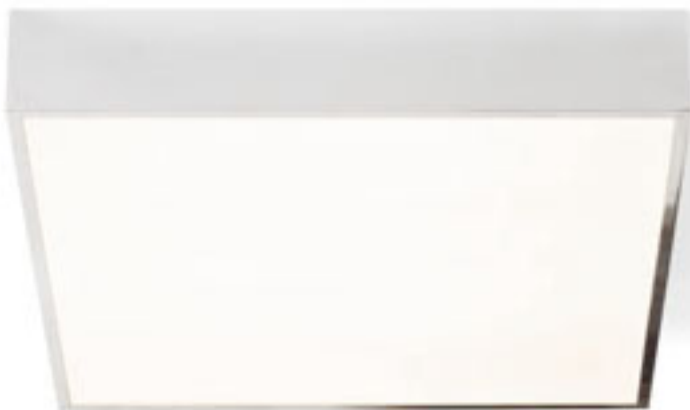
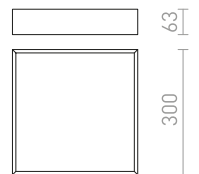

IP44

**MERANO LED 35 TETO**

230 V LED 24 W 3000 K 1700 lm Ra 80 IP44

R13698 cromo/acrílico fosco

€ 215

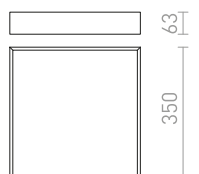



## COLIN

Luminária de teto em gesso para casquilho GU10. Pode ser pintada com tintas para interiores.

### COLIN TETO

230 V LED GU10 5 W

R13791 gesso

€ 58

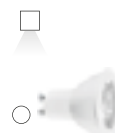

G13466

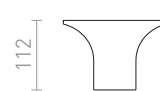

112

68

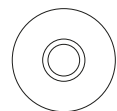

166



## GINA

Luminária de teto em gesso para fonte de luz LED com casquilho GU10. A luminária pode ser pintada com tinta para interiores.

### GINA III TETO

230 V LED GU10 3x5 W

R13789 gesso

€ 120

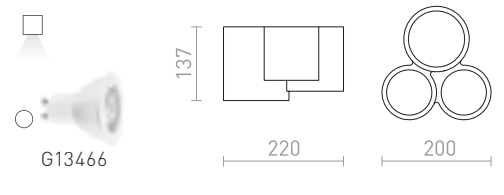

## GINA

Luminária de teto de gesso para casquilho GU10. Pode ser pintada com tintas para interiores.

### GINA TETO

230 V LED GU10 15 W

R11680 gesso

€ 78

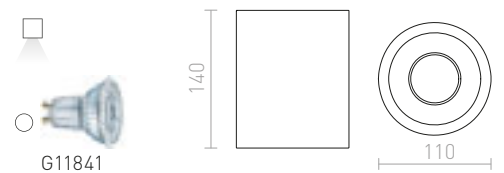

### GINA S 17 TETO

230 V GU10 15 W

R12354 gesso

€ 58

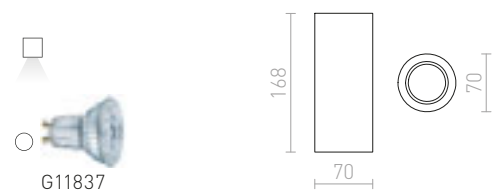





## JACK

Luminária de teto em gesso para fonte de luz LED com casquilho GU10. A luminária pode ser pintada com tinta para interiores.

### JACK III TETO

230 V LED GU10 3x5 W

R13790 gesso

€ 150

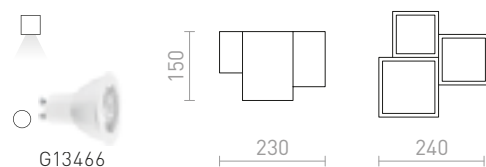

G13466

230

240



## JACK

Luminária angular de gesso para fonte de luz com casquilho GU10. A luminária pode ser pintada com tintas para interiores.

### JACK SQ TETO

230 V LED GU10 15 W

R11957 gesso

€ 78

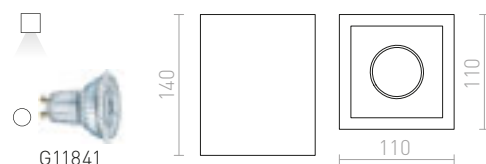

G11841

140

110

110

### JACK SQ S 17 TETO

230 V GU10 15 W

R12751 gesso

€ 32 %

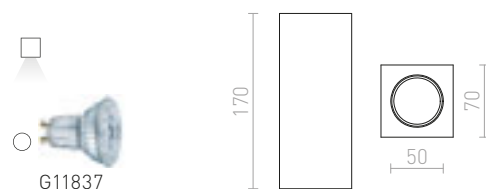

G11837

170

50

70



## VOLCA

Luminária de teto em cimento para fontes de luz LED com casquilho GU10.

### VOLCA TETO

230 V LED GU10 5 W

R13795 cimento/granito escuro

€ 48

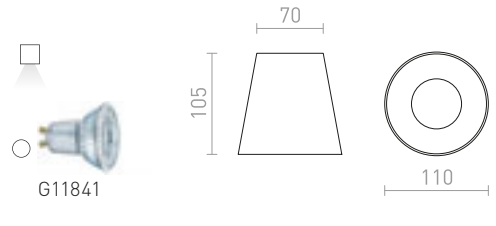

## COLES

Luminária de teto para uma fonte de luz que pode ser inclinada em um eixo. A luminária pode ser pintada com tintas para interiores.

### COLES SQ LUZ DE TETO

230 V LED GU10 15 W

R13438 gesso

€ 58

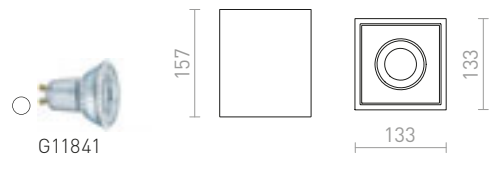

## COLES

Luminária de teto para uma fonte de luz que pode ser inclinada em um eixo. A luminária pode ser pintada com tintas para interiores.

### COLES DIRECIONAL DE TETO

230 V GU10 15 W

R10454 gesso

€ 120

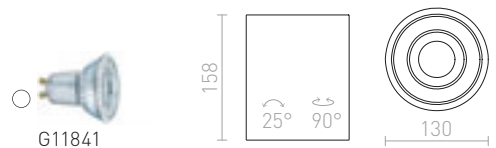







## SOLARIS

Um candeeiro de superfície em vidro com uma base lacada a preto. Adequado para fontes de luz LED com uma rosca E14.

### SOLARIS MONTADO À SUPERFÍCIE

230 V LED E14 7 W

**R13994** vidro transparente/preto

€ 78

NEW

**R13995** vidro fosco/preto

€ 78

NEW

**R13996** vidro de cor fumo/preto

€ 78

NEW

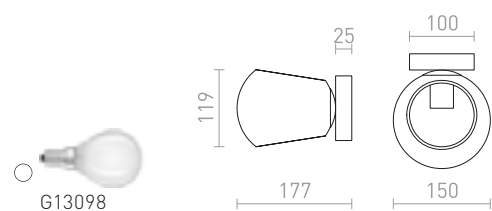



## TACO

Foco cilíndrico de teto com um abajur têxtil e casquilho E27, adequado para fontes de luz com eficiência energética.

### TACO TETO

230 V E27 15 W

R12471 preto/cromo

€ 48 %

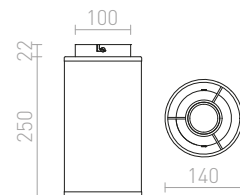

## OTIS

Luminária têxtil dupla redonda de teto para fontes de luz E27. A tonalidade interna é sempre branca.

### OTIS 60 TETO

230 V E27 4x28 W

R13807 branco/branco

€ 420

R13808 preto transparente/branco

€ 420

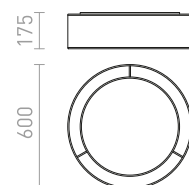
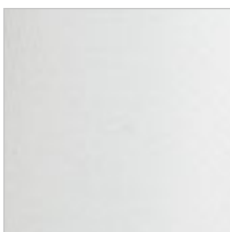



## MARA

Luminária de teto de LED com base cromada e difusor ligeiramente convexo.

### MARA TETO

230 V LED 24 W 3000 K 1760 lm Ra 80

R12894 acrílico fosco/cromo

€ 88

%

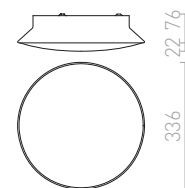

IP44

## VENICE

Luminária de teto com um abajur combinado, composto por um vidro transparente no exterior e um vidro opalino no interior, situada sobre numa base cromada e com um casquilho E27 para fontes de luz LED. Adequado para utilização em casas de banho.

### VENICE 23 TETO

230 V E27 20 W IP44

R13684 vidro transparente/vidro colorido opala/cromo

€ 198



G13307

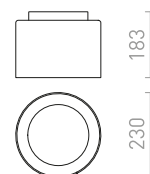

IP44

## VENICE

Plafon LED com um abajur combinado, composto por um vidro transparente exterior e um vidro opalino interior, situado numa base cromada e com LED incorporado. Adequado para utilização em casas de banho.

### VENICE LED 30 TETO

230 V LED 12 W 3000 K 900 lm Ra 80 IP44

R13685 vidro transparente/vidro colorido opala/cromo

€ 248

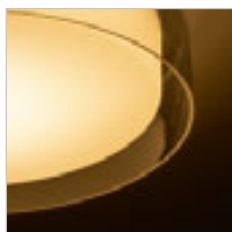
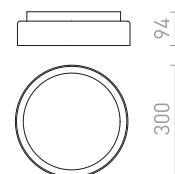





## BOGARD

Luminária de teto LED com um foco fixo e um ajustável.

### BOGARD TWIN TETO

230 V LED 2x5 W  $\angle 40^\circ$  3000 K 700 lm Ra 80

R12499 mate preto

€ 120

R12500 níquel mate

€ 88

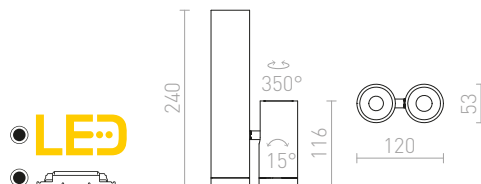

## BOGARD

Foco direcional tubular LED de teto ajustável.

### BOGARD TETO

230 V LED 5 W  $\angle 40^\circ$  3000 K 414 lm Ra 80

R12497 mate preto

€ 68

R12498 níquel mate

€ 78



## BELENOS

Foco cilíndrico minimalista para fontes de luz GU10 sobre base redonda. As molas ligadas ao casquilho permitem o uso de fontes de luz de vários comprimentos.

### BELENOS TETO

230 V LED GU10 9 W

R13363 branco

€ 48

R13364 preto

€ 48

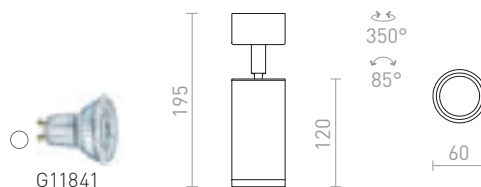



### CONDU

Luminária de teto cilíndrica sólida e inclinável com LED integrado.

#### CONDU TETO

230 V LED 20 W  $\angle 24^\circ$  3000 K 1600 lm Ra 80

R12839 branco

€ 120

R12840 preto

€ 120

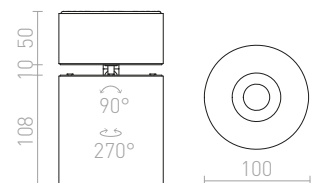

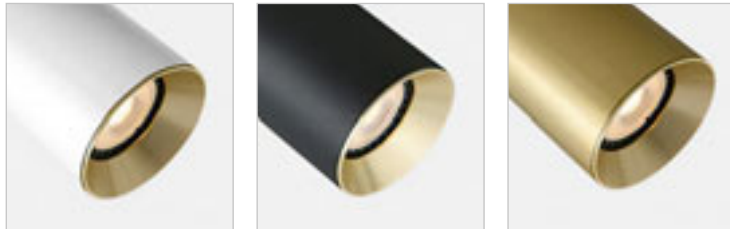

## PIXIE

Luminária de teto de alumínio para fontes de luz LED GX53 de baixo consumo energético.

### PIXIE TETO

230 V LED GX53 7 W

R11770 branco/cromo

€ 138

R11771 preto/cromo

€ 138

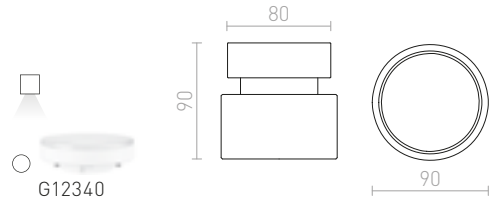

## DARIO

Luminária cilíndrica direcional com casquilho GU10 para fontes de luz LED, que inclui um tom decorativo de latão preto escovado. Diferentes combinações de cores estão disponíveis comprando tons adicionais em outras cores.

### DARIO TETO

230 V GU10 9 W

R13867 branco/latão escovado

€ 68

NEW

R13868 preto/latão escovado

€ 68

NEW

R13869 latão escovado

€ 78

NEW

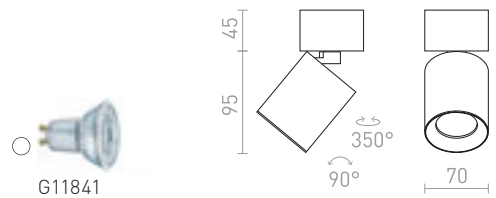

## DARIO

Tonalidade decorativa interna de metal em várias cores para a luz DARIO.

### DARIO ANEL DECORATIVO

R13876 branco

€ 8.50

NEW

R13877 preto

€ 8.50

NEW

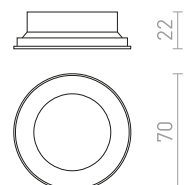



### PIXIE

Luminária inclinada na base para fontes de luz LED GX53 de baixo consumo energético.

#### PIXIE DIRECIONAL

230 V LED GX53 7 W

R11772 branco/cromo

€ 138

R11773 preto/cromo

€ 138

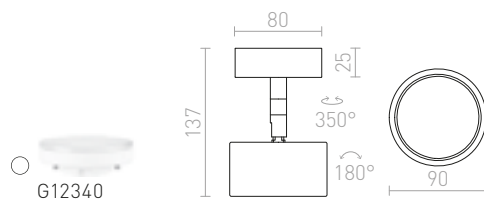

### SNAZZY

Luminária de teto cilíndrica inclinável para fontes de luz GU10.

#### SNAZZY

230 V GU10 35 W

R12670 branco

€ 78

R13552 preto

€ 78

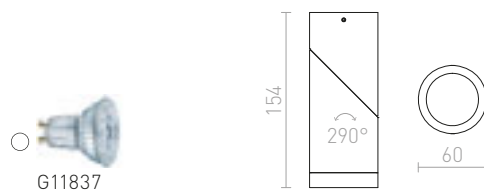





## KELLY LED

Luminária de teto regulável com fonte de luz LED fixa integrada. Regulação da intensidade da luz TRIAC.

### KELLY LED DIMM TETO

230 V LED 15 W  $\angle 45^\circ$  3000 K 750 lm Ra 85

R12633 branco

€ 120

R12634 preto

€ 120

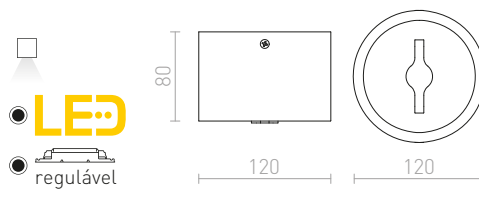

## RIGA

Luz de teto com LED integrado, disponível em quatro cores.

### RIGA 18 TETO

230 V LED 4 W  $\angle 38^\circ$  3000 K 285 lm Ra 80

R12448 cromo

€ 68

%

R12449 cobre

€ 68

%

R12450 branco

€ 78

R12451 preto

€ 78



### RIGA 38 TETO

230 V LED 6 W  $\angle 38^\circ$  3000 K 570 lm Ra 80

R12452 cromo

€ 68

%

R12453 cobre

€ 68

%

R12454 branco

€ 78

R12455 preto

€ 78

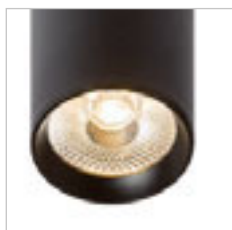



## CONNOR

Foco de teto cilíndrico com casquilho GU10 fixo.

### CONNOR TETO

230 V LED GU10 10 W

R13496 branco/preto

€ 48

R13501 preto/ouro

€ 48



G11841

96

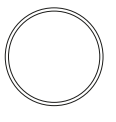

69



## CANTO

Foco de teto cilíndrico adequado para combinar com anel decorativo Canto.

### CANTO FOCO SEM ABAJUR INTERNO

230 V LED GU10 8 W

R13471 branco

€ 48

R13472 preto

€ 48



G11841

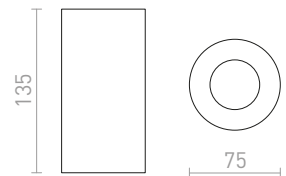

## CANTO

Anel decorativo, disponível em quatro cores para candeeiro Canto.

### CANTO ANEL DECORATIVO

R13473 branco

€ 6

R13474 ouro

€ 6

R13475 folha de cobre

€ 6

R13476 preto

€ 6

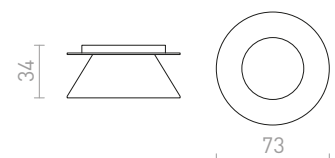



### TUBA

Foco de teto cilíndrico para fontes de luz fixas GU10.

#### TUBA TETO

230 V GU10 35 W

R12745 mate branco/ouro

€ 48

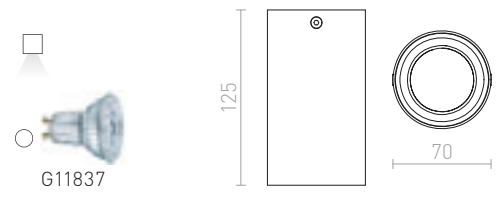

### VADE

Foco de teto para fontes de luz fixas GU10.

#### VADE R

230 V GU10 35 W

R12669 branco/preto

€ 48

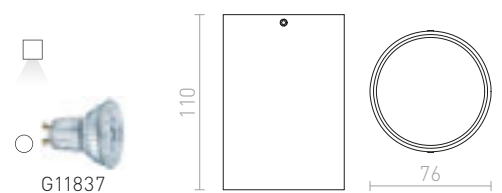



## MAYO

Foco cilíndrico direcional montado em superfície com LED integrado. Driver incluído.

### MAYO R TETO DIRECIONAL

230 V LED 9 W  $\angle 36^\circ$  2700 K 400 lm Ra 80

R10374 alumínio escovado

€ 78 %

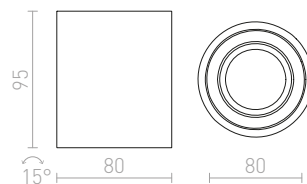

## MEA

Luz de teto cilíndrica para fonte de luz E27 de baixo consumo energético, com cobertura em vidro acetinado.

### MEA TETO CILÍNDRICO

230 V E27 18 W

R10212 alumínio escovado

€ 58 %

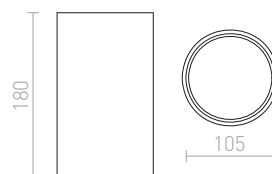

## MOCCA

Luminária cilíndrica de alumínio polido com fonte de luz inclinável.

### MOCCA TETO

230 V GU10 50 W

R10124 alumínio

€ 78 →

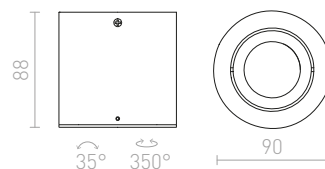



## MOMA

Luminária de teto cilíndrica inclinável para fonte de luz com casquilho GU10.

### MOMA DIRECIONAL

230 V GU10 35 W

R12044 branco

€ 58

R12517 preto

€ 58

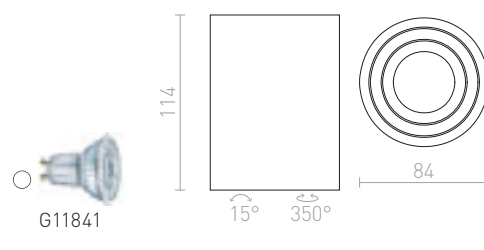

## MOMA

Luminária de teto cilíndrica para uma fonte de luz halógena fixa com uma altura máxima de 56 mm.

### MOMA TETO

230 V GU10 35 W

R12043 branco

€ 35

R12047 níquel mate

€ 26

R12516 preto

€ 35

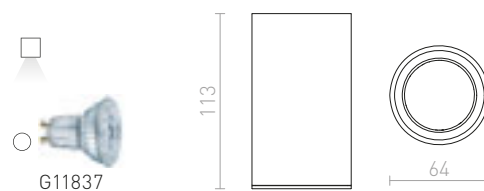



## MANTOVA

Luminária de teto com casquilho fixo GU10.

### MANTOVA I TETO

230 V GU10 35 W

**R12729** mate branco

€ 38

**R12730** alumínio escovado

€ 38

**R12731** mate preto

€ 38

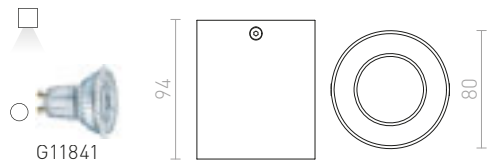

### MANTOVA II TETO

230 V GU10 2x35 W

**R12732** mate branco

€ 68

**R12733** alumínio escovado

€ 48

**R12734** mate preto

€ 68



## GAYA

Foco de teto cilíndrico montado em superfície para fonte de luz com casquilho GU10.

### GAYA

230 V GU10 35 W

**R12667** branco

€ 35

**R12668** preto

€ 35

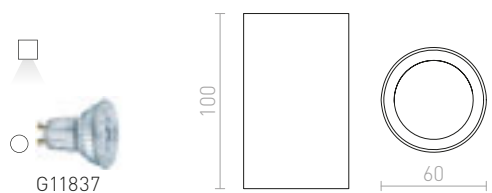



## MILANO

Luminária de teto montada em superfície com inclinação para fontes de luz GU10.

### MILANO I TETO

230 V GU10 35 W

**R12681** mate preto/alumínio escovado

€ 48

**R12682** alumínio escovado

€ 48

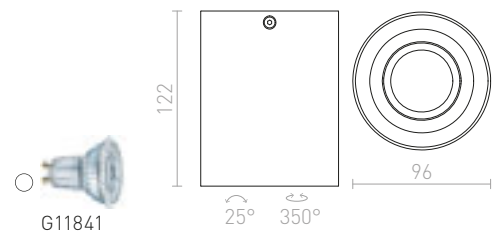

### MILANO II TETO

230 V GU10 2x35 W

**R12684** alumínio escovado

€ 68

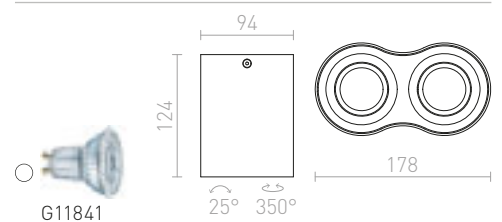







## AGATE

Luminária de teto angular para fontes de luz com casquilho GU10 fixo.

### AGATE I TETO

230 V GU10 35 W

**R12735** mate branco

€ 35

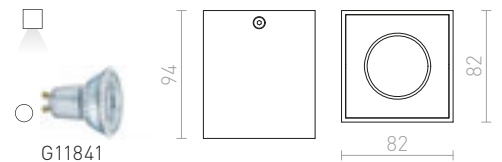

### AGATE II TETO

230 V GU10 2x35 W

**R12737** mate branco

€ 58

**R12738** alumínio escovado

€ 35

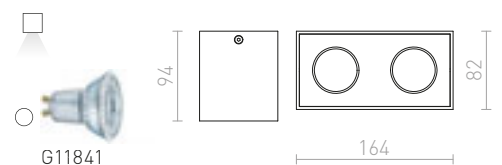

## ENKI

Luminária de teto angular montada em superfície com inclinação e casquilho GU10.

### ENKI EDG I

230 V GU10 35 W

**R12672** branco

€ 58

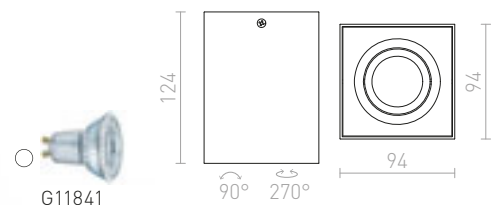

### ENKI EDG II

230 V GU10 2x35 W

**R12673** branco

€ 98

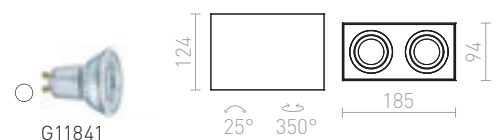



## BERIT

Luminária de teto retangular em alumínio para fontes de luz GU10 inclináveis em dois eixos.

### BERIT I TECTO

230 V GU10 50 W

R10119 alumínio

€ 58 %

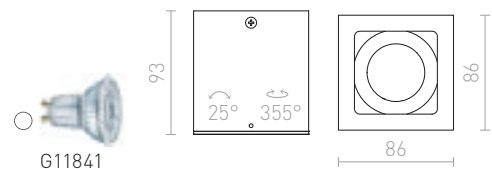

### BERIT II TECTO

230 V GU10 2x50 W

R10120 alumínio

€ 68 %





## JAMES

Luminária de teto lacada com LED embutido que pode ser inclinado em dois eixos. Regulação da intensidade da luz TRIAC.

### JAMES I DIMM TETO

230 V LED 15 W  $\angle 24^\circ$  3000 K 800 lm Ra 80

R13361 mate branco

€ 88

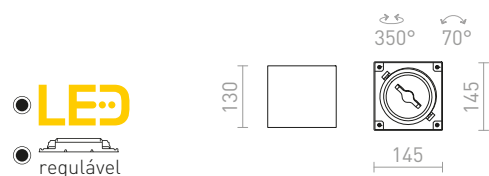

### JAMES II DIMM TETO

230 V LED 2x15 W  $\angle 24^\circ$  3000 K 1600 lm Ra 80

R13362 mate branco

€ 158

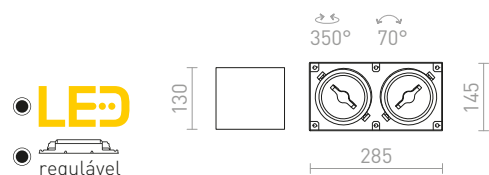

## MAYO

Foco angular montado em superfície com LED integrado. Driver incluído.

### MAYO SQ TETO DIRECIONAL

230 V/700 mA LED 9 W  $\angle 36^\circ$  2700 K 400 lm Ra 80

R10326 branco

€ 120

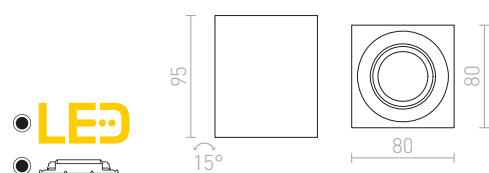





## MARVEL

Luminária angular de alumínio para duas fontes de luz GU10 que podem ser inclinadas individualmente em base central.

### MARVEL II DIRECIONAL

230 V GU10 2x50 W

R10171 alumínio

€ 48 %

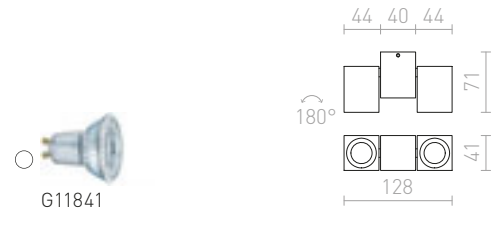

## MARVEL

Luminária angular de alumínio para fontes de luz GU10, sem inclinação.

### MARVEL TETO

230 V GU10 50 W

R10122 alumínio

€ 14.50 %

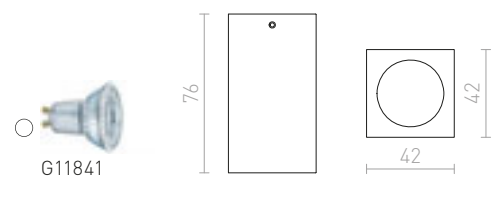

### MARVEL II TECTO

230 V GU10 2x50 W

R10123 alumínio

€ 15.50 %

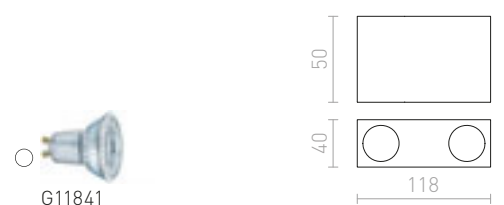



## MEZZO

Plafon de teto com fonte de luz LED embutida e moldura de alumínio lacada. O equipamento é fornecido com um difusor de luz em policarbonato fosco. Com o kit de suspensão (R13330 ou R13331), o plafon pode ser instalado como suspenso. Regulação da intensidade da luz TRIAC.

### MEZZO 40 DIMM TETO

230 V LED 30 W 3000 K 1800 lm Ra 80

R13328 branco

€ 258

R13329 preto

€ 258

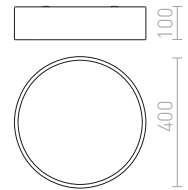
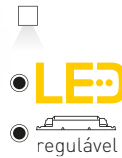

### MEZZO 60 DIMM TETO

230 V LED 60 W 3000 K 3700 lm Ra 80

R13332 branco

€ 480

R13333 preto

€ 480

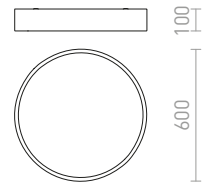
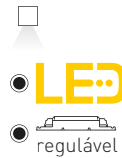

### MEZZO 80 DIMM TETO

230 V LED 100 W 3000 K 6400 lm Ra 80

R13334 branco

€ 850

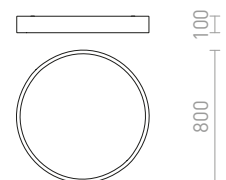
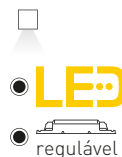









## LARISA

Plafon com LED e moldura minimalista.

### LARISA R 12 TETO

230 V LED 10 W 3000 K 800 lm Ra 80

**R12842** branco € 58

**R12843** ouro pérola € 58

**R13479** preto € 58



LED

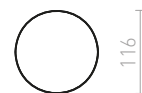
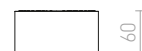

### LARISA R 22 TETO

230 V LED 20 W 3000 K 1600 lm Ra 80

**R13481** branco € 98

**R13482** ouro pérola € 98

**R13483** preto € 98



LED

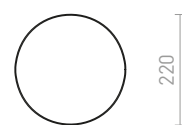
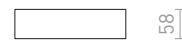

### LARISA R 30 TETO

230 V LED 30 W 3000 K 2400 lm Ra 80

**R12844** branco € 138

**R12845** ouro pérola € 150

**R13480** preto € 138



LED

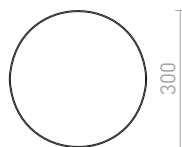
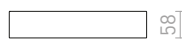

### LARISA R 40 TETO

230 V LED 50 W 3000 K 4000 lm Ra 80

**R13484** branco € 215

**R13485** ouro pérola € 215

**R13486** preto € 215



LED

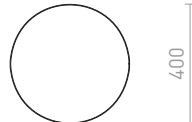
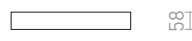



## LARISA

Plafon com LED e moldura minimalista. Regulação da intensidade da luz TRIAC.

### LARISA R 12 DIMM TETO

230 V LED 10 W 3000 K 800 lm Ra 80

**R13157** branco € 88

**R13164** ouro pérola € 88

**R13551** preto € 88



regulável

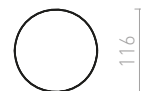
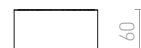

### LARISA R 22 DIMM TETO

230 V LED 20 W 3000 K 1600 lm Ra 80

**R13743** ouro pérola € 138

**R13843** preto € 129

**R13844** branco € 129



regulável

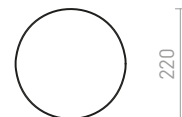

### LARISA R 30 DIMM TETO

230 V LED 30 W 3000 K 2400 lm Ra 80

**R13177** branco € 178

**R13178** ouro pérola € 178

**R13570** preto € 178



regulável

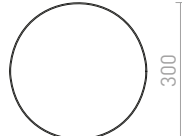
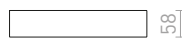







## HUE

Luminária muito fina montada em superfície com LED de alta potência integrado. A moldura está disponível em cromo, cromo preto, níquel mate, laca branca e imitação de madeira.

### HUE R 9 TETO

230 V LED 6 W 3000 K 540 lm Ra 80

<b>R12790</b> branco	€ 26	➔
<b>R12791</b> cromo preto	€ 19.50	%
<b>R12792</b> cromo	€ 24	%
<b>R12794</b> faixa decorativa	€ 28	➔



LED

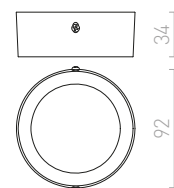

### HUE R 17 TETO

230 V LED 18 W 3000 K 1620 lm Ra 80

<b>R12795</b> branco	€ 58	➔
<b>R12798</b> níquel mate	€ 48	%
<b>R12799</b> faixa decorativa	€ 48	%
<b>R13404</b> imitação de imbuia escura	€ 48	%



LED

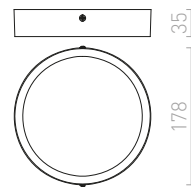

### HUE R 22 TETO

230 V LED 24 W 3000 K 2160 lm Ra 80

<b>R12800</b> branco	€ 68	➔
<b>R12804</b> faixa decorativa	€ 68	%
<b>R13405</b> imitação de imbuia escura	€ 68	%



LED

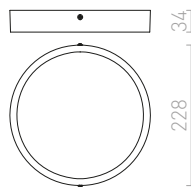



## HUE

Luminária muito fina montada em superfície com LED de alta potência integrado e regulável. A moldura está disponível em cromo, cromo preto, níquel mate, laca branca e imitação de madeira. Regulação da intensidade da luz TRIAC.

### HUE R 9 DIMM TETO

230 V LED 6 W 3000 K 540 lm Ra 80

<b>R13137</b> branco	€ 58
<b>R13138</b> cromo preto	€ 58
<b>R13139</b> cromo	€ 58
<b>R13141</b> faixa decorativa	€ 58



LED

regulável

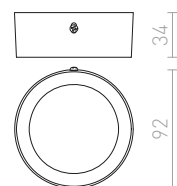

### HUE R 17 DIMM DE TETO

230 V LED 18 W 3000 K 1620 lm Ra 80

<b>R13073</b> branco	€ 120
<b>R13076</b> níquel mate	€ 120
<b>R13077</b> faixa decorativa	€ 120
<b>R13444</b> imitação de imbuia escura	€ 120



LED

regulável

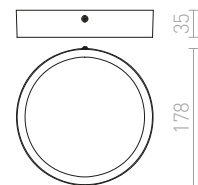

### HUE R 22 DIMM DE TETO

230 V LED 24 W 3000 K 2160 lm Ra 80

<b>R13078</b> branco	€ 129
<b>R13082</b> faixa decorativa	€ 138
<b>R13445</b> imitação de imbuia escura	€ 129



LED

regulável

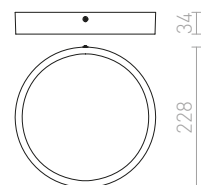









## MENSA

Plafon LED de teto quadrado com moldura em alumínio. Inclui um difusor de acrílico fosco.

### MENSA R 80 TETO

230 V LED 80 W 3000 K 6800 lm Ra 80

R12119 alumínio escovado

€ 560 %



LED

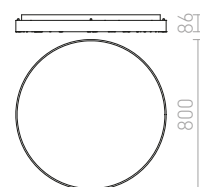

## ALLEGRO

Plafon LED com moldura de alumínio pintado. Inclui difusor embutido em acrílico fosco. Regulação da intensidade da luz TRIAC.

### ALLEGRO II 43 DIMM TETO

230 V LED 30 W 3000 K 1950 lm Ra 80

R13730 branco

€ 360



LED



regulável

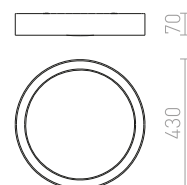

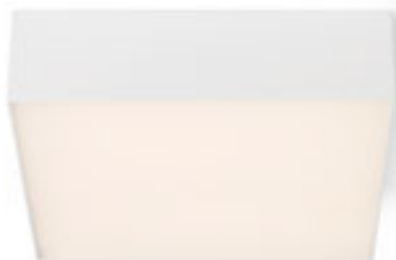

## LARISA

Plafon com LED e moldura minimalista.

### LARISA SQ 17 TETO

230 V LED 15 W 3000 K 1200 lm Ra 80

R12848 branco

€ 78

R12849 preto

€ 78

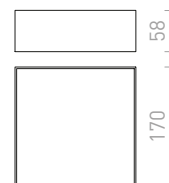

### LARISA SQ 22 TETO

230 V LED 20 W 3000 K 1600 lm Ra 80

R13487 branco

€ 88

R13488 preto

€ 88

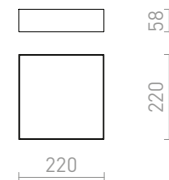

### LARISA SQ 30 TETO

230 V LED 30 W 3000 K 2400 lm Ra 80

R12850 branco

€ 138

R12851 preto

€ 138

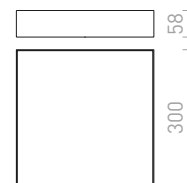

### LARISA SQ 40 TETO

230 V LED 50 W 3000 K 4000 lm Ra 80

R13489 branco

€ 188

R13490 preto

€ 188

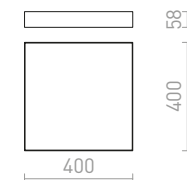







## LARISA

Plafon com LED e moldura minimalista. Regulação da intensidade da luz TRIAC.

### LARISA SQ 17 DIMM TETO

230 V LED 15 W 3000 K 1200 lm Ra 80

R13158 branco

€ 98

R13938 preto

€ 98

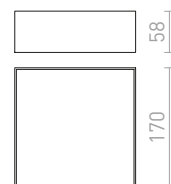
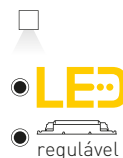

### LARISA SQ 22 DIMM DE TETO

230 V LED 20 W 3000 K 1600 lm Ra 80

R13851 branco

€ 120

R13939 preto

€ 120

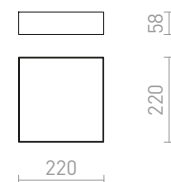
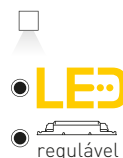

### LARISA SQ 30 DIMM TETO

230 V LED 30 W 3000 K 2400 lm Ra 80

R13267 branco

€ 178

R13268 preto

€ 178

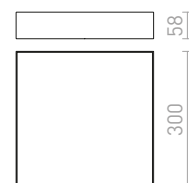
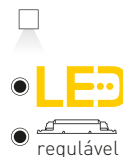

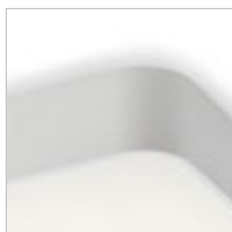
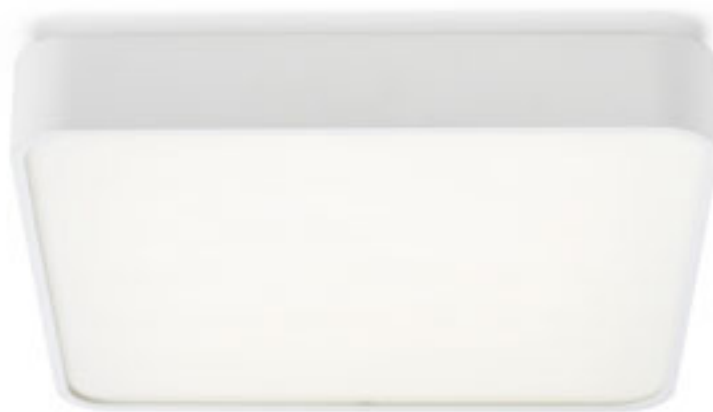

## MENSA

Plafon LED quadrado de teto com moldura em alumínio lacado ou escovado. Inclui um difusor de acrílico fosco. Inclui um difusor de acrílico fosco.

### MENSA SQ 40 TETO

230 V LED 38 W 3000 K 2470 lm Ra 80

R10582 branco

€ 198 %

R11290 alumínio escovado

€ 220 %

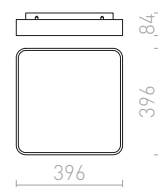
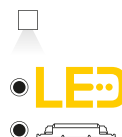

### MENSA SQ 48 TETO

230 V LED 56 W 3000 K 3640 lm Ra 80

R11299 alumínio escovado

€ 178 %

R12120 branco

€ 268 →

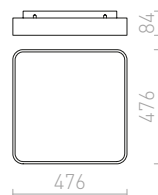
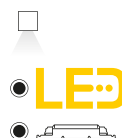

### MENSA SQ 80 TETO

230 V LED 138 W 3000 K 8700 lm Ra 80

R12121 alumínio escovado

€ 580 %

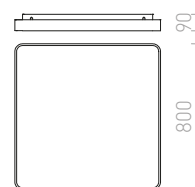
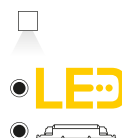







## STRUCTURAL

Plafon LED montado em superfície com moldura em alumínio lacado. Inclui o driver.

### STRUCTURAL LED 40x40 DE SUPERFÍCIE

230 V LED 40 W 3000 K 2918 lm Ra 80

R12063 branco

€ 215



regulamento  
opcional

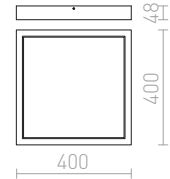

## STRUCTURAL

Plafon LED em perfil de alumínio, design elegante em alumínio natural ou lacado a branco com difusor PMMA opalino com iluminação embutida.

### STRUCTURAL LED 20x20 DE SUPERFÍCIE

230 V LED 12 W 3000 K 900 lm Ra 80

R13707 branco

€ 150 →

R13708 alumínio escovado

€ 150 →

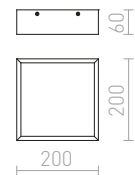

### STRUCTURAL LED 55x55 DE SUPERFÍCIE

230 V LED 48 W 3000 K 3600 lm Ra 80

R13711 branco

€ 229 %

R13712 alumínio escovado

€ 229 %

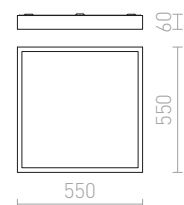
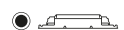







## HUE

Luminária muito fina montada em superfície com LED de alta potência integrado. A moldura está disponível em cromo, cromo preto, níquel mate, laca branca e imitação de madeira.

### HUE SQ 9 TETO

230 V LED 6 W 3000 K 540 lm Ra 80

R12805	branco	€ 24	➔
R12806	cromo preto	€ 18	%
R12807	cromo	€ 17	%
R12808	níquel mate	€ 15	%

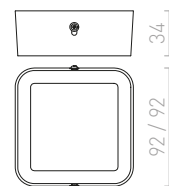
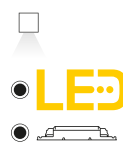

### HUE SQ 17 TETO

230 V LED 18 W 3000 K 1620 lm Ra 80

R12810	branco	€ 58	➔
R12811	cromo preto	€ 32	%
R12812	cromo	€ 35	%
R12813	níquel mate	€ 32	%
R12814	faixa decorativa	€ 58	➔

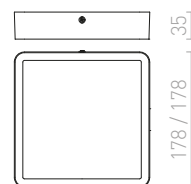
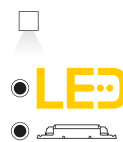

### HUE SQ 22 TETO

230 V LED 24 W 3000 K 2160 lm Ra 80

R12815	branco	€ 78	➔
R12816	cromo preto	€ 48	%
R12817	cromo	€ 48	%
R12818	níquel mate	€ 35	%

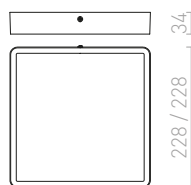
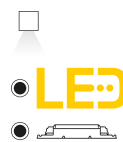



## HUE

Luminária muito fina montada em superfície com LED de alta potência integrado. A moldura está disponível em cromo, cromo preto, níquel mate, laca branca e imitação de madeira. Regulação da intensidade da luz TRIAC.

### HUE SQ 9 DIMM TETO

230 V LED 6 W 3000 K 540 lm Ra 80

<b>R13142</b> branco	€ 58	→
<b>R13143</b> cromo preto	€ 58	→
<b>R13144</b> cromo	€ 58	→
<b>R13145</b> níquel mate	€ 58	→

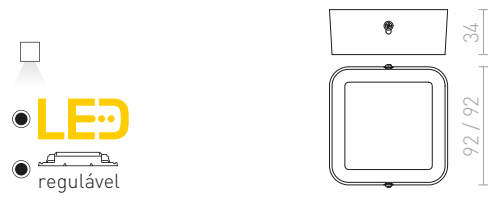

### HUE SQ 17 DIMM DE TETO

230 V LED 18 W 3000 K 1620 lm Ra 80

<b>R13083</b> branco	€ 120	→
<b>R13084</b> cromo preto	€ 120	→
<b>R13085</b> cromo	€ 120	→
<b>R13086</b> níquel mate	€ 120	→
<b>R13087</b> faixa decorativa	€ 120	→

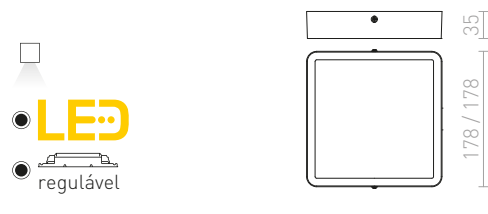

### HUE SQ 22 DIMM DE TETO

230 V LED 24 W 3000 K 2160 lm Ra 80

<b>R13088</b> branco	€ 138	→
<b>R13089</b> cromo preto	€ 129	→
<b>R13090</b> cromo	€ 129	→
<b>R13091</b> níquel mate	€ 129	→

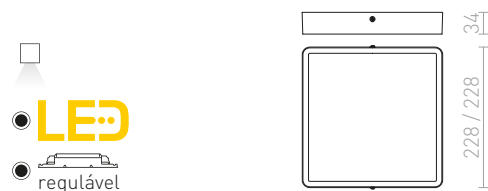





## SOCORRO

Luminária plana montada em superfície com LED integrado.

### SOCORRO R 300 DE SUPERFÍCIE

230 V LED 24 W 3000 K 1920 lm Ra 80

R12973 branco

€ 58

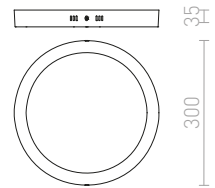

## SLENDER

Luminária LED fina montada em superfície.

### SLENDER R 12 SUPERFÍCIE

230 V LED 6 W 3000 K 540 lm Ra 80

R11281 níquel mate

€ 17

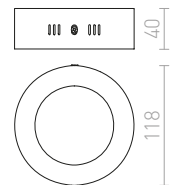
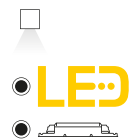

### SLENDER SQ 12 SUPERFÍCIE

230 V LED 6 W 3000 K 540 lm Ra 80

R11284 níquel mate

€ 17

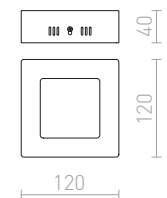
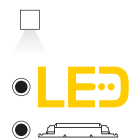

### SLENDER SQ 22 MONTADO EM SUPERFÍCIE

230 V LED 18 W 3000 K 1620 lm Ra 80

R11285 níquel mate

€ 32

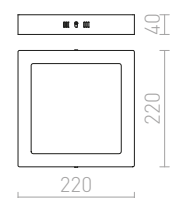
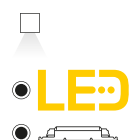









## MELISA

Luminária montada em superfície com LED integrado, abajur de acrílico fosco e moldura de alumínio escovado.

### MELISA 25 TETO

230 V LED 12 W 3000 K 840 lm Ra 80

R11296 alumínio

€ 58

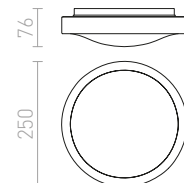
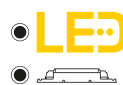

### MELISA 52 TETO

230 V LED 40 W 3000 K 2200 lm Ra 80

R11297 alumínio

€ 120

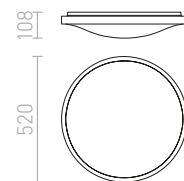

## SEMPRE

Plafon com LED integrado e cobertura de acrílico fosco.

### SEMPRE R 55 TETO

230 V LED 56 W 3000 K 3920 lm Ra 80

R12434 acrílico fosco

€ 178

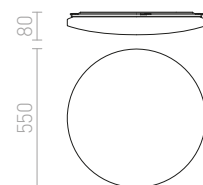
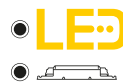

### SEMPRE SQ 63 TETO

230 V LED 76 W 3000 K 5320 lm Ra 80

R12439 acrílico fosco

€ 215

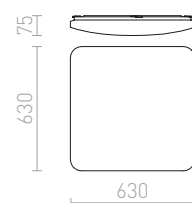





## SEMPRE

Plafon com cobertura de acrílico fosco, LED e sensor de movimento incorporados.

### SEMPRE SQ 33 SENSOR TETO

230 V LED 24 W 3000 K 1680 lm Ra 80

R12440 acrílico fosco

€ 120 →

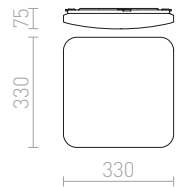

### SEMPRE SQ 43 SENSOR TETO

230 V LED 36 W 3000 K 2520 lm Ra 80

R12441 acrílico fosco

€ 150 →

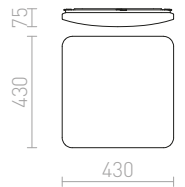

### SEMPRE SQ 53 SENSOR TETO

230 V LED 56 W 3000 K 3920 lm Ra 80

R12442 acrílico fosco

€ 188 →

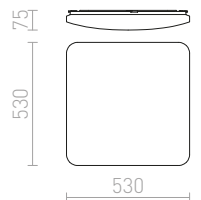

### SEMPRE SQ 63 SENSOR TETO

230 V LED 76 W 3000 K 5320 lm Ra 80

R12443 acrílico fosco

€ 129 %

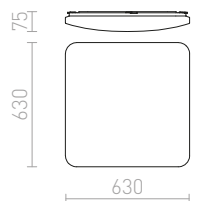



## STRUCTURAL

Luminária LED montada em superfície com moldura em alumínio pintado. Inclui um driver incorporado.

### STRUCTURAL LED 60x15 DE SUPERFÍCIE

230 V LED 22 W 3000 K 1370 lm Ra 80

R12064 branco

€ 120 %

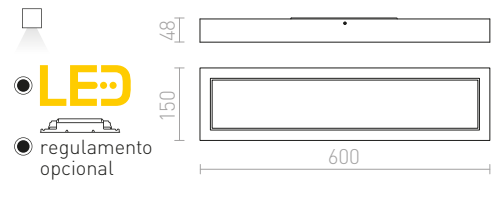

IP65



## TRIDENT PRO

Luminária industrial linear LED para montagem em teto ou suspenso com kit G13672. Alto desempenho e proteção IP65. Fornecido sem kit de suspensão e cabo de alimentação. Possibilidade de ligação entre luminárias em série.

### TRIDENT PRO 120 CORPO

230 V LED 40 W 4000 K 5200 lm Ra 80 IP65

G13670 cinzento/acrílico fosco

€ 58

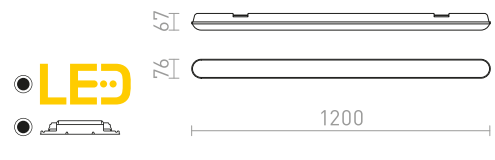

### TRIDENT PRO 150 CORPO

230 V LED 60 W 4000 K 7800 lm Ra 80 IP65

G13671 cinzento/acrílico fosco

€ 88

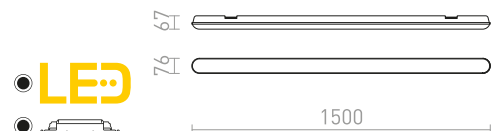





## CANDEEIROS DE PAREDE

CASA DE BANHO	184-209
DECORATIVO	210-219
COMBINADO	220-223
COM UM BRAÇO	224-227
GESSO	228-237
INDIRETO	238-239
ACIMA - ABAIXO	240-255
SOBRE QUADROS	256-259
DEBAIXO DOS ARMÁRIOS	260-261
ILUMINAÇÃO DE ORIENTAÇÃO	262-265



# CANDEEIROS DE PAREDE

## CASA DE BANHO



**SWAY**  
184-185



**PANON SHORT**  
184-185



**PANON LONG**  
184-185

184-209



**IMPERISO 60**  
184-185



**MONET 84**  
186-187



**LUIZA 60**  
186-187



**CASSAMBA 60**  
186-187



**PALEA 300**  
188-189



**PALEA 500**  
188-189

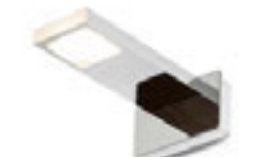

**PARAGNA**  
188-189



**MAREA 60**  
188-189



**YOLO SQ**  
190-191



**PARIS**  
190-191



**SAVOY 24**  
190-191



**BALEA 500**  
190-191



**LEVIA 60**  
192-193



**LEVIA 90**  
192-193



**LEVIA 120**  
192-193



**AMENITY 60**  
194-195



**AMENITY 90**  
194-195



**AMENITY 120**  
194-195



**PERISA 60**  
194-195



**PERISA 90**  
194-195



**IMPERIA 90**  
196-197



**IMPERIA 120**  
196-197



**ADAGIO 60**  
196-197



**MARINA LED 60**  
198-199



**MARINA LED 90**  
198-199



**MARINA LED 120**  
198-199



**CRESCENDO 90**  
200-201



**MIRANDA 60**  
200-201



**MIRANDA 120**  
200-201



**TAMPA 60**  
202-203



**TAMPA**  
202-203



**FLORIO 49**  
202-203



**CORAZON 60**  
204-205



**CORAZON 90**  
204-205



**FAO 90**  
204-205



**LINN I**  
206-207



**LINN III**  
206-207



**BOLLY III**  
206-207



**VALTO I**  
206-207



**VALTO III**  
206-207



**DUBLIN I**  
208-209



**DUBLIN II**  
208-209



**DUBLIN III**  
208-209



**DUBLIN IV**  
208-209

## CANDEEIROS DE PAREDE DECORATIVO

210-219



**CALLUM RR4 250**  
210-211



**CALLUM RL2 250**  
210-211



**CALLUM RD2 250**  
210-211



**GLANS RR2 150**  
212-213



**GLANS RB2 165**  
212-213



**RON W 15/25**  
214-215



**LOPE W 25/14**  
214-215



**SELENA**  
216-217



**SOLARIS**  
216-217



**JERSEY**  
218-219



**SHARP**  
218-219



**HUDSON**  
218-219

## CANDEEIROS DE PAREDE COMBINADO

220-223



**VERSA**  
220-221



**VERSINA**  
220-221



**PERTH**  
220-221



**TIARA**  
222-223



**PLAZA**  
222-223



**TAINA**  
222-223

## CANDEEIROS DE PAREDE COM UM BRAÇO

224-227



**MADISON W**  
224-225



**ASHLEY**  
224-225



**MONTANA**  
226-227



**ANTE**  
226-227

## CANDEEIROS DE PAREDE GESSO

228-237



**GINA S**  
228-229



**CHIC**  
228-229



**BODIE**  
228-229



**BENITA**  
228-229



**GRANITA II**  
228-229



**GAN**  
230-231



**VERITA**  
230-231



**COWLEY**  
230-231



**CRESCENT**  
232-233



**CRESCENT L**  
232-233



**SID**  
232-233



**JACK SQ**  
234-235



**JACK RC S**  
234-235



**HAY**  
234-235



**KUBIS**  
234-235



**ROLO 36**  
236-237



**ROLO 45**  
236-237



**WIM**  
236-237

CANDEEIROS DE PAREDE  
**INDIRETO**

238-239



**FOND**  
238-239



**BRUXEL 12**  
238-239



**VIENNA**  
238-239



**ATHI**  
238-239



**ATLANTA 13**  
238-239

CANDEEIROS DE PAREDE  
**ACIMA - ABAIXO**

240-255



**TITO R**  
240-241



**TITO SQ**  
240-241



**CARRE**  
240-241



**DAFFY**  
242-243



**BIARITZ**  
242-243



**TUBA W**  
242-243



**MIDZACK**  
242-243



**MOIRE I**  
244-245



**MOIRE II**  
244-245



**MICO I**  
244-245



**MICO II**  
244-245



**MARIO**  
246-247



**REEM**  
246-247



**ROZA**  
246-247



**TAPA**  
246-247



**NAXOS**  
246-247



**TRIP SQ**  
248-249



**ESSEX**  
248-249



**ONYX**  
248-249



**DIDO**  
248-249



**KORSO II**  
248-249



**PEKKO**  
248-249



**AGATE II**  
250-251



**DESMOND II**  
250-251



**NICK II**  
250-251



**UKKO**  
250-251



**CHLOE**  
252-253



**LEA**  
252-253



**TORINO**  
252-253



**NEMAN**  
252-253



**TWIST**  
254-255



**PRIO LED 62**  
254-255

## CANDEEIROS DE PAREDE SOBRE QUADROS



256-259

**SWAY**  
256-257



**SWING**  
256-257



**PANON LONG**  
256-257



**LUISA 60**  
258-259



**IMPERISO 60**  
258-259



**MAREA 60**  
258-259

## CANDEEIROS DE PAREDE DEBAIXO DOS ARMÁRIOS

260-261



**FLORIO 49**  
260-261



**CORAZON 60**  
260-261



**CORAZON 90**  
260-261

## CANDEEIROS DE PAREDE ILUMINAÇÃO DE ORIENTAÇÃO

262-265



**AQILA R**  
262-263



**AQILA RC**  
262-263



**AMBER**  
262-263



**TICO I**  
262-263



**AQILA SQ**  
262-263



**BOBO R**  
264-265



**BOBO RC**  
264-265



**BOBO SQ**  
264-265



IP44



IP44

### PANON

Luminária LED linear com base central. Adequada para uso em ambientes húmidos.

#### PANON SHORT NA PAREDE

230 V LED 18 W 3000 K 1700 lm Ra 80 IP44

R12949 cromo

€ 138

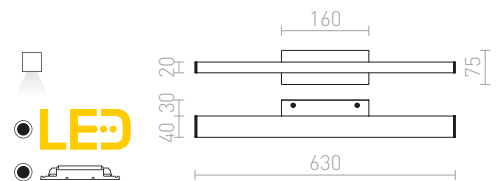

#### PANON LONG NA PAREDE

230 V LED 12 W 3000 K 900 lm Ra 80 IP44

R12950 cromo

€ 120

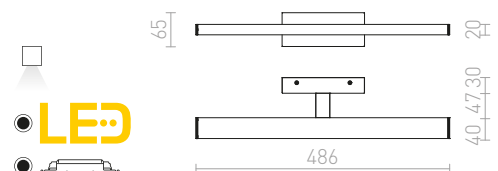



IP44

**SWAY**

Luminária LED linear inclinável, ideal acima de espelhos ou quadros.

**SWAY CASA DE BANHO**

230 V LED 12 W 3000 K 1060 lm Ra 80 IP44

R12951 cromo

€ 120

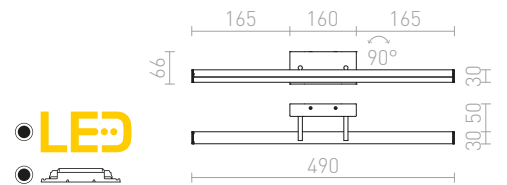

IP44

**IMPERISO**

Luminária linear LED adequada para colocar acima de espelho. A frente pode girar no eixo horizontal. Para uso em ambientes húmidos.

**IMPERISO 60**

230 V LED 18 W 3000 K 1769 lm Ra 80 IP44

R13555 branco

€ 248

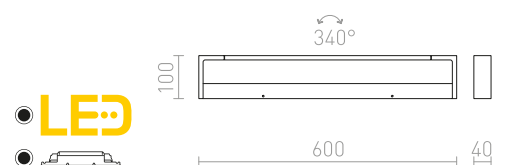





IP44



## MONET

Luminária linear de LED acima de espelho, adequada para áreas húmidas.

### MONET 84 NA PAREDE

230 V LED 29 W 3000 K 1892 lm Ra 80 IP44

R13337 acrílico fosco/cromo

€ 278 →



LED

50

250

87

835

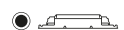



IP54

**LUISA**

Luminária linear LED com iluminação descendente, adequada para colocar acima do espelho. Para uso em ambientes húmidos.

**LUISA 60 NA PAREDE**

230 V LED 12 W 3000 K 1138 lm Ra 80 IP54

R13735 branco

€ 150

R13853 preto

€ 150

NEW

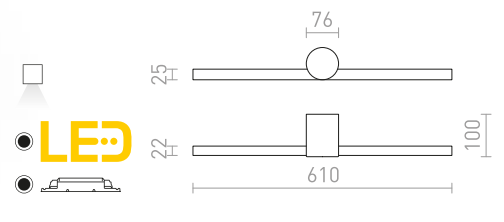

IP44

**CASSAMBA**

Candeiro de parede em forma de tubo com LED incorporado numa base oblonga, adequado para casas de banho. A temperatura de cor da luz pode ser alterada usando um interruptor no interior da base: 3000K ou 4000K.

**CASSAMBA 60 NA PAREDE**

230 V LED 12 W 3000 K 4000 K 700 lm Ra 80 IP44

R13888 preto/acrílico fosco

€ 178

NEW

R13889 cromo/acrílico fosco

€ 178

NEW

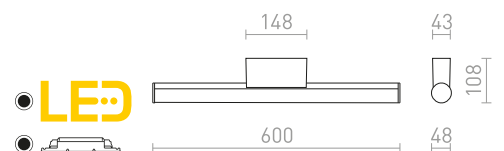



IP44

## PALEA

Luminária de parede para casa de banho com tecnologia LED. Adequada para uso em ambientes húmidos.

### PALEA 500

230 V LED 7 W 3000 K 308 lm Ra 80 IP44

R10613 cromo

€ 150

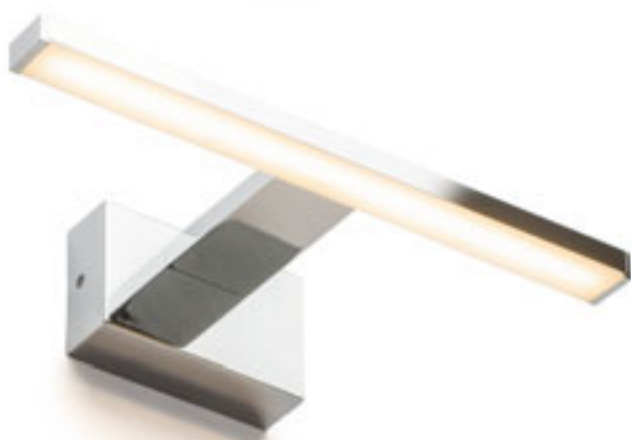
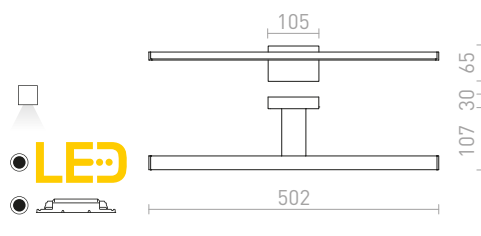

IP44

### PALEA 300

230 V LED 4,4 W 3000 K 189 lm Ra 80 IP44

R10614 cromo

€ 120

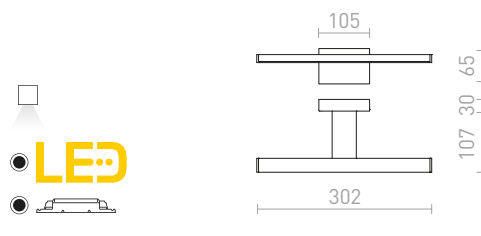

IP44

## PARAGNA

Luminária de parede de casa de banho com tecnologia LED.

### PARAGNA NA PAREDE

230 V LED 5,7 W 3000 K 246 lm Ra 80 IP44

R10612 cromo

€ 78

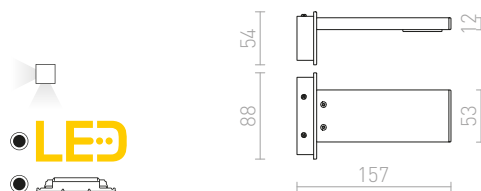



IP44

## MAREA

Luminária linear LED com iluminação descendente, adequada para colocar acima do espelho. Para uso em ambientes húmidos.

### MAREA 60 NA PAREDE

230 V LED 18 W 3000 K 1954 lm Ra 80 IP44

R13554 branco

€ 188

R13852 preto

€ 188

NEW

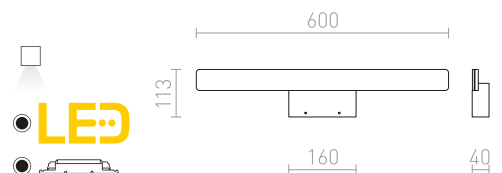

IP44

## PARIS

Luz para casa de banho com LED integrado de metal sólido cromado adequada para armários e prateleiras.

### PARIS PARA ARMÁRIOS

230 V LED 3 W  $\angle 120^\circ$  3000 K 210 lm Ra 80 IP44

R12398 cromo

€ 68 %

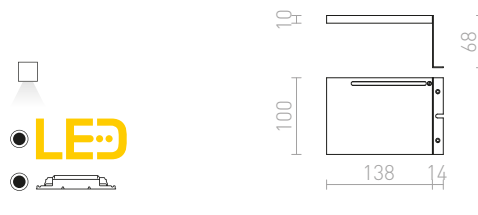

IP44

## SAVOY

Luz retangular de metal cromado para casa de banho com iluminação bidirecional adequada para armários e prateleiras.

### SAVOY 24 PARA ARMÁRIOS

230 V LED 8 W  $\angle 120^\circ$  3000 K 300 lm Ra 80 IP44

R12399 cromo

€ 88 %

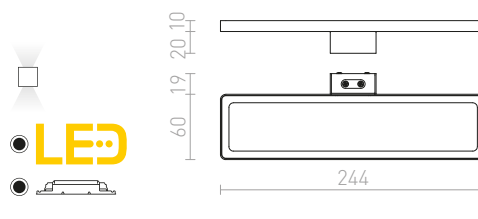

IP44

## BALEA

Luminária linear para casa de banho com LED integrado e um braço para montagem em gabinetes ou prateleiras.

### BALEA 500 PARA ARMÁRIOS

230 V LED 7 W  $\angle 120^\circ$  3000 K 370 lm Ra 80 IP44

R12400 cromo

€ 120

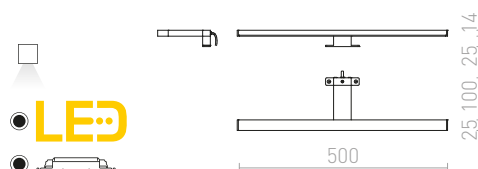



IP44



### YOLO

Luz para casa de banho com LED integrado que pode ser montada em armários ou espelhos.

#### YOLO SQ ACIMA DE ESPELHO

12 V= LED 4 W 3000 K 215 lm Ra 80 IP44

R10588 cromo

€ 48 %

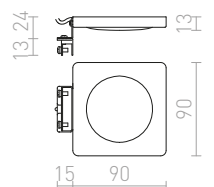



### LEVIA

Luminária LED de parede linear. Adequada para ambientes húmidos. A luz pode ser montada em armários ou prateleiras usando o conjunto de suportes R12581.

#### LEVIA 60 NA PAREDE

230 V LED 12 W  $\angle 120^\circ$  3000 K 900 lm Ra 80 IP44

R12401 alumínio € 150

R12402 cromo € 150



#### LEVIA 90 NA PAREDE

230 V LED 18 W  $\angle 120^\circ$  3000 K 1300 lm Ra 80 IP44

R12403 alumínio € 198

R12404 cromo € 215



#### LEVIA 120 NA PAREDE

230 V LED 24 W  $\angle 120^\circ$  3000 K 1700 lm Ra 80 IP44

R12405 alumínio € 248

R12406 cromo € 258



IP44

IP44

IP44

### LEVIA

Suportes cromados para montagem em armários de R102401, R12402, R12403, R12404, R12405 e R12406.

#### LEVIA CONJUNTO DE ALÇAS EM ARMÁRIO

R12581 cromo € 3.80

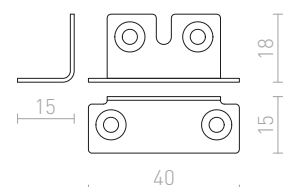





IP44



IP44

## PERISA

Luminária linear para tubos fluorescentes ideal acima de espelhos. Disponível em alumínio ou lacada de branco. Adequada para ambientes húmidos.

### PERISA 60 NA PAREDE

230 V G5 14 W IP44

R10262 branco

€ 98

%

R10264 alumínio escovado

€ 120

%



### PERISA 90 NA PAREDE

230 V G5 21 W IP44

R10263 branco

€ 78

%

R10265 alumínio escovado

€ 120

%

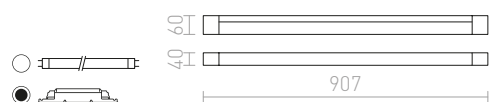



IP44



IP44



IP44



### AMENITY

Luminária de parede linear com LED integrado e pontas cromadas. Adequada para ambientes húmidos.

#### AMENITY 120 NA PAREDE

230 V LED 14 W 3000 K 830 lm Ra 80 IP44

R12641 cromo

€ 229



#### AMENITY 90 NA PAREDE

230 V LED 11 W 3000 K 580 lm Ra 80 IP44

R12640 cromo

€ 215



#### AMENITY 60 NA PAREDE

230 V LED 8 W 3000 K 400 lm Ra 80 IP44

R12639 cromo

€ 178







IP44

**ADAGIO**

Luminária angular sólida com difusor de plástico e acessórios cromados, adequada para ambientes húmidos.

**ADAGIO 60 NA PAREDE**

230 V G5 24 W IP44

R12217 cromo

€ 120 %

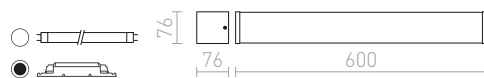

IP44

**IMPERIA**

Luminária retangular para casa de banho com cobertura de plástico e acessórios cromados.

**IMPERIA 120 NA PAREDE**

230 V G5 28 W IP44

R12219 cromo

€ 158 %



IP44

**IMPERIA 90 NA PAREDE**

230 V G5 39 W IP44

R12218 cromo

€ 150 %



IP44



IP44



IP44

## MARINA

Luminária linear montada na parede com LED integrado para iluminação bidirecional. Adequada para ambientes húmidos.

### MARINA LED 60 NA PAREDE

230 V LED 14 W 3000 K 550 lm Ra 80 [IP44](#)

R11993 cromo

€ 178

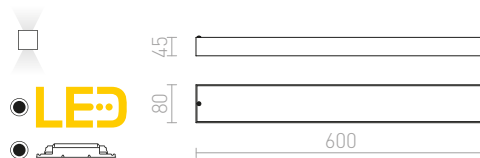

### MARINA LED 90 NA PAREDE

230 V LED 19 W 3000 K 800 lm Ra 80 [IP44](#)

R11996 cromo

€ 238

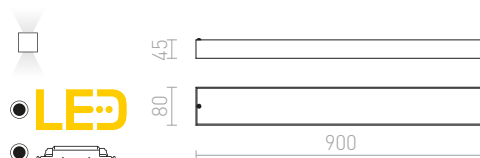

### MARINA LED 120 NA PAREDE

230 V LED 25 W 3000 K 950 lm Ra 80 [IP44](#)

R11998 cromo

€ 360

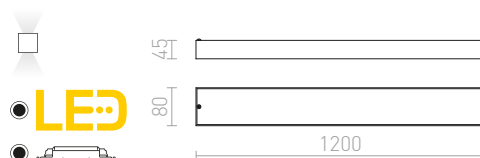







IP44

### MIRANDA

Luminária linear com LED integrado adequada para ambientes húmidos.

#### MIRANDA 60 NA PAREDE

230 V LED 8 W 3000 K 470 lm Ra 80 IP44

R12407 cromo

€ 150

%

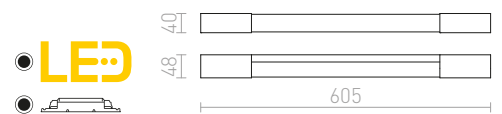

#### MIRANDA 120 NA PAREDE

230 V LED 14 W 3000 K 1000 lm Ra 80 IP44

R12409 cromo

€ 220

%



IP44



IP44

### CRESCENDO

Luminária para casa de banho com cobertura redonda de plástico e acessórios cromados. Ideal acima de espelhos. Pode ser instalado em ambientes húmidos.

#### CRESCENDO 90 NA PAREDE

230 V G5 39 W IP44

R12220 cromo

€ 150

%







IP44



## FLORIO

Luminária LED indicada para casa de banho, com ficha integrada para aparelhos de baixo consumo até 100W.

### FLORIO 49 PAREDE

230 V LED 8W 3000 K 640 lm Ra 80 IP44

R12903 branco

€ 88

R12904 cromo

€ 98



## TAMPA

Luminária linear para casa de banho com LED integrado, ideal acima de espelhos, com opção de comprar terminais em diferentes cores (R12906, R12907, R12908).

### TAMPA 60 NA PAREDE SEM TERMINAIS

230 V LED 15W 3000 K 1400 lm Ra 80 IP44

R12905 branco

€ 68



IP44



## TAMPA

Terminais em separado disponíveis em três cores para uso com R12905.

### TAMPA TERMINAIS 2 PÇS

R12906 branco

€ 2.20

R12907 cinzento prata

€ 3.80

R12908 cromo

€ 5.50

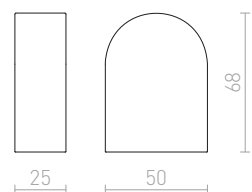







IP44

### FAO

Luminária linear montada em superfície com cobertura de acrílico fosco para ambientes húmidos.

#### FAO 90 NA PAREDE

230 V G5 21 W IP44

R10491 cromo

€ 78 %



IP44

### CORAZON

Luminária linear com LED integrado, adequada para ambientes húmidos.

#### CORAZON 60

230 V LED 15 W 3000 K 1200 lm Ra 80 IP44

R12901 cromo

€ 78

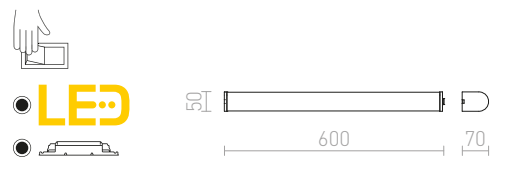

IP44

#### CORAZON 90

230 V LED 20 W 3000 K 1600 lm Ra 80 IP44

R12902 cromo

€ 120

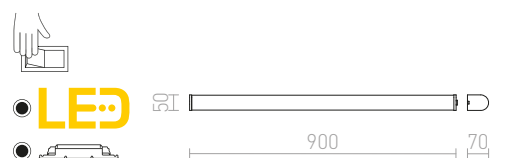



IP44



IP44

## LINN

Candeeiro de parede ou teto com vidro opalino e base cromada. Adequado para casas de banho.

### LINN III DE SUPERFÍCIE

230 V G9 LED 3x3 W IP44

R13703 vidro colorido opala/cromo

€ 120

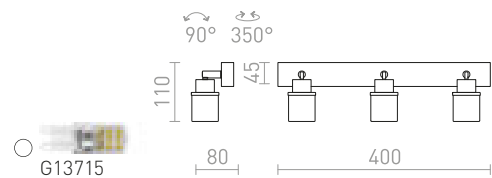

### LINN I NA PAREDE

230 V G9 LED 3 W IP44

R13695 vidro colorido opala/cromo

€ 48

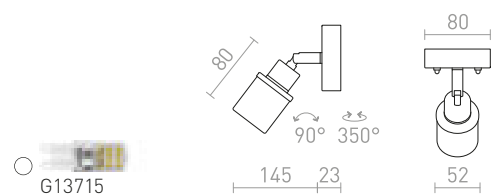



IP44



### BOLLY

Luminária de parede ou teto com vidro opalino sobre base cromada. Adequado para ambientes húmidos.

#### BOLLY III DE SUPERFÍCIE

230 V G9 LED 3x3 W IP44

R13691 vidro colorido opala/cromo

€ 129

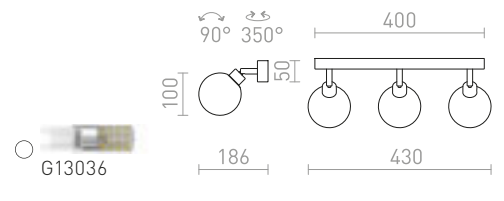

IP44

### VALTO

Luminária de parede ou teto com refletores inclináveis para fontes de luz LED com casquilho GU10. Adequado para casas de banho.

#### VALTO III DE SUPERFÍCIE

230 V GU10 LED 3x5 W IP44

R13704 cromo

€ 88

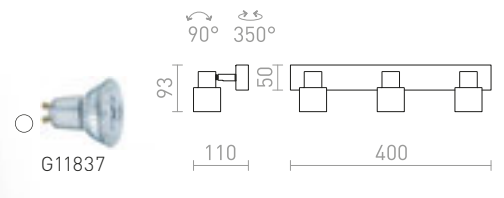

IP44

#### VALTO I NA PAREDE

230 V GU10 LED 5 W IP44

R13696 cromo

€ 48

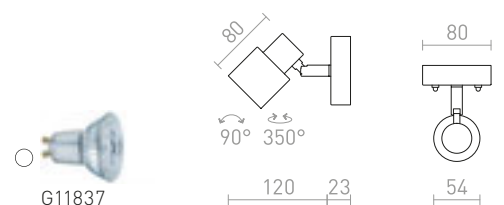





IP44

### DUBLIN

Foco cromado adequado para casas de banho.

#### DUBLIN I DE SUPERFÍCIE

230 V GU10 9 W IP44

R13377 cromo

€ 48

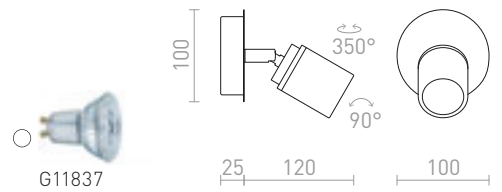

IP44

#### DUBLIN II DE SUPERFÍCIE

230 V GU10 2x9 W IP44

R13378 cromo

€ 78

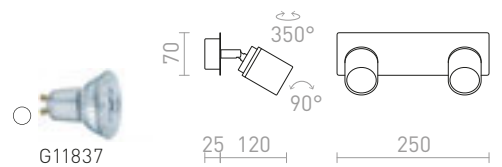

IP44

#### DUBLIN III DE SUPERFÍCIE

230 V GU10 3x9 W IP44

R13379 cromo

€ 98

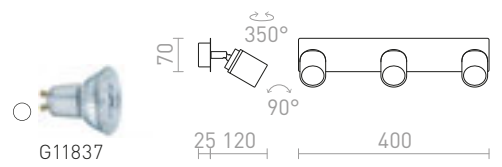

IP44

#### DUBLIN IV DE SUPERFÍCIE

230 V GU10 4x9 W IP44

R13380 cromo

€ 129

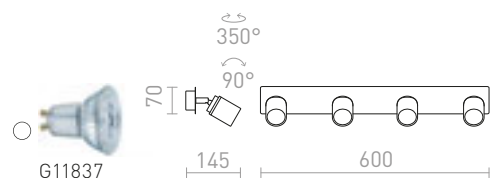







## CALLUM

Um candeeiro de parede criado por impressão 3D. O abajur é feito de material PLA ecológico, que é totalmente degradável.

### CALLUM RD2 250 NA PAREDE

230 V LED E27 10 W

R13999 branco/Eco PLA

€ 129

NEW

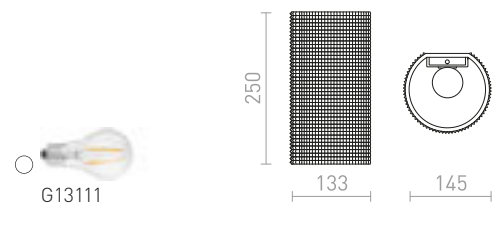

### CALLUM RR4 250 NA PAREDE

230 V LED E27 10 W

R13997 branco/Eco PLA

€ 129

NEW

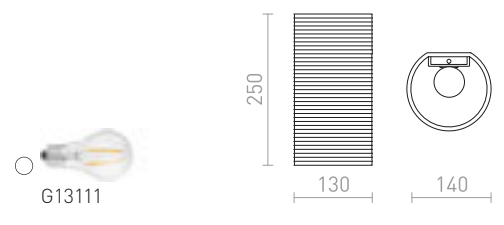

### CALLUM RL2 250 NA PAREDE

230 V LED E27 10 W

R13998 branco/Eco PLA

€ 129

NEW

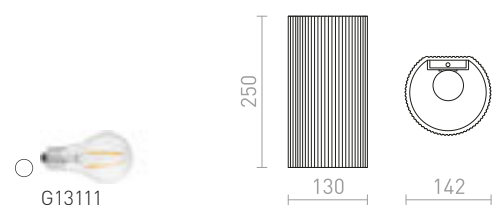

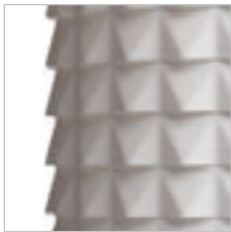

## GLANS

Um candeeiro de parede criado por impressão 3D. O abajur é feito de material PLA ecológico, que é totalmente degradável.

### GLANS RB2 165 NA PAREDE

230 V LED G9 5 W

R14001 branco/Eco PLA

€ 120 **NEW**

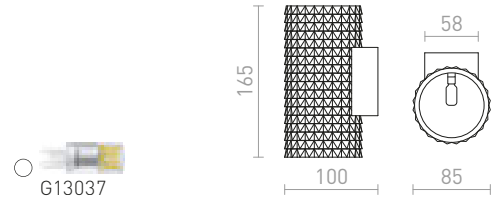

### GLANS RR2 150 NA PAREDE

230 V LED G9 5 W

R14000 branco/Eco PLA

€ 120 **NEW**

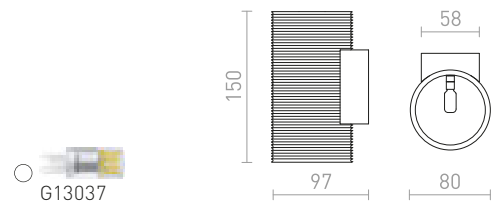





## RON

Luminária de parede com abajur têxtil.

### RON W 15/25 NA PAREDE

230 V E27 28 W

	<b>R11368</b> Poli-algodão preto/folha de cobre	€ 158
	<b>R11464</b> Poli-algodão preto/folha dourada	€ 158
	<b>R11492</b> Poli-algodão branco/PVC branco	€ 120
	<b>R11509</b> Alperce de chita/PVC branco	€ 120
	<b>R11519</b> Chita laranja/PVC branco	€ 120
	<b>R11548</b> Chita menta/folha de prata	€ 129
	<b>R11557</b> Chita cinza claro/PVC branco	€ 120
	<b>R11567</b> Chita limão/PVC branco	€ 120
	<b>R11575</b> monaco gasolina azul/prata PVC	€ 129
	<b>R11586</b> monaco pomba gris/prata PVC	€ 129

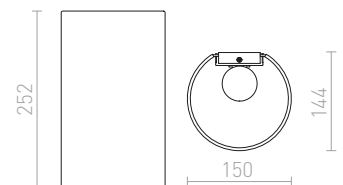



## LOPE

Luminária de parede com abajur têxtil.

### LOPE W 25/14 NA PAREDE

230 V E27 28 W

	<b>R11365</b> Poli-algodão preto/folha dourada	€ 150
	<b>R11377</b> Poli-algodão preto/folha de cobre	€ 150
	<b>R11381</b> Chita azeitona/folha de prata	€ 78 %
	<b>R11383</b> Chita menta/folha de prata	€ 150
	<b>R11504</b> Poli-algodão branco/PVC branco	€ 120
	<b>R11512</b> Alperce de chita/PVC branco	€ 120
	<b>R11522</b> Chita laranja/PVC branco	€ 120
	<b>R11560</b> Chita cinza claro/PVC branco	€ 120
	<b>R11570</b> Chita limão/PVC branco	€ 120

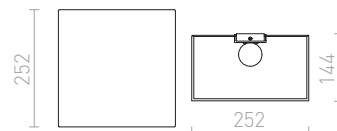



## SELENA

Candeeiro de parede em tecido com interruptor de puxar. O abajur pode ser girado sobre um eixo.

### SELENA NA PAREDE

230 V E27 15 W

R13651 preto

€ 120 ➔



G13014

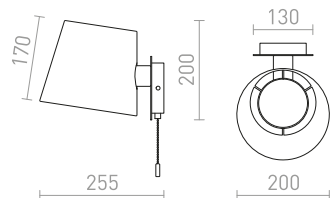



## SOLARIS

Um candeeiro de superfície em vidro com uma base lacada a preto. Adequado para fontes de luz LED com uma rosca E14.

### SOLARIS MONTADO À SUPERFÍCIE

230 V LED E14 7 W

**R13994** vidro transparente/preto

€ 78 NEW

**R13995** vidro fosco/preto

€ 78 NEW

**R13996** vidro de cor fumo/preto

€ 78 NEW

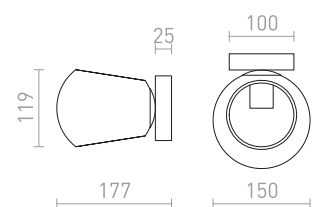



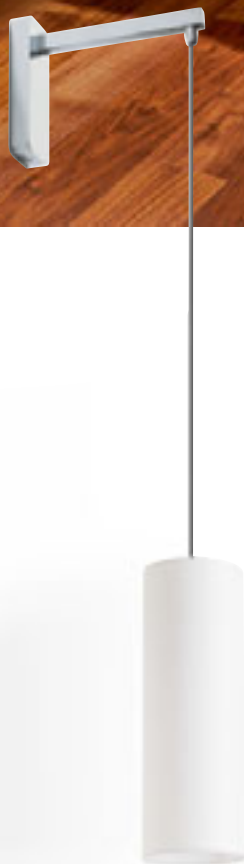

## HUDSON

Luminária de parede com braço cromado, cabo vertical e abajur cilíndrico têxtil.

### HUDSON NA PAREDE

230 V E27 28 W

R13284 branco/cromo

€ 138

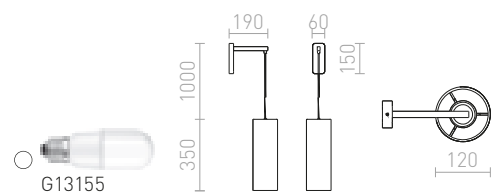



## SHARP

Luminária de parede com abajur têxtil e interruptor na base.

### SHARP NA PAREDE

230 V E27 42 W

R12481 preto/cromo

€ 78 %

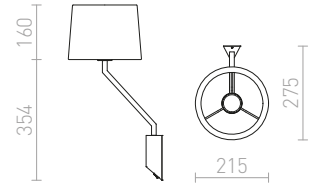

## JERSEY

Luminária de parede elegante inclinável. O abajur é coberto com tecido texturado.

### JERSEY NA PAREDE

230 V E27 42 W

R11976 branco/cromo

€ 178

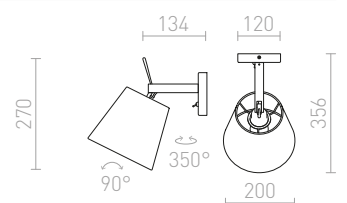
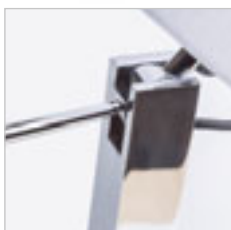



## VERSA

Luminária LED de parede com abajur têxtil e foco adicional com braço flexível. As duas fontes de luz podem funcionar separadamente com interruptores localizados na base.

### VERSA PAREDE COM ABAJUR

230 V E27 LED 42 W + 3 W  $\angle 40^\circ$  3000 K 240 lm Ra 80

**R10580** branco/níquel mate

**€ 178**



G13026  
**LED**

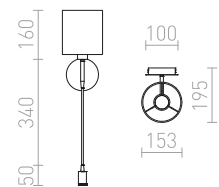

## VERSINA

Luminária de parede com abajur têxtil, complementada com foco LED sobre braço flexível. As duas fontes de luz podem funcionar separadamente com interruptores colocados na base.

### VERSINA COM ABAJUR

230 V E27 LED 28 W + 3 W  $\angle 25^\circ$  3000 K 180 lm Ra 80

**R12955** branco/cromo

**€ 129**



G13026  
**LED**

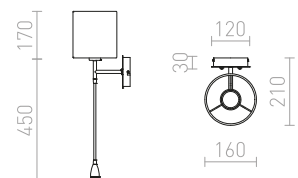

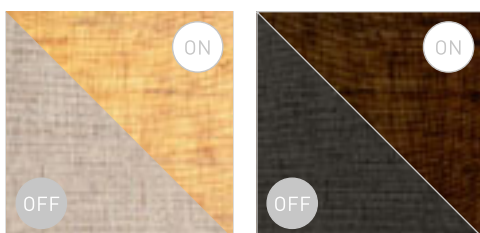

## PERTH

Candeeiro de parede com abajur quadrado em tecido complementado por braço flexível com refletor LED. O candeeiro possui duas fontes de luz, que podem ser controladas separadamente por um interruptor rotativo localizado na base quadrada do candeeiro.

### PERTH NA PAREDE COM FOCO LED

230 V E14 LED 15 W + 3 W  $\angle 30^\circ$  3000 K 150 lm Ra 80

**R13661** bege/branco/cromo € 178

**R13662** preto/preto/cromo € 178

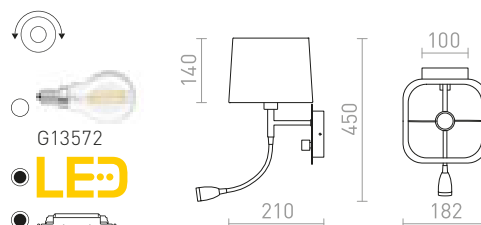



## PLAZA

Luminária de parede com abajur têxtil texturado, para fontes de luz E27 e LED 3W para leitura. Ambas as fontes de luz são controladas separadamente por um interruptor na base.

### PLAZA NA PAREDE COM SPOT LED

230 V E27 LED 42 W + 3 W 3000 K 140 lm Ra 80

R11982 branco/cromo

€ 188



G13026

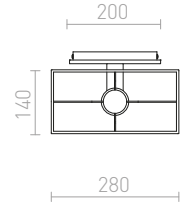
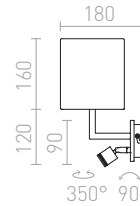

## TIARA

Luminária de parede LED com refletor e iluminação indireta superior. Possui duas fontes de luz que podem ser controladas separadamente por interruptores localizados na base da luminária.

### TIARA NA PAREDE

230 V LED 2x3 W  $\angle 25^\circ$  3000 K 300 lm Ra 80

R12957 cromo

€ 68

%

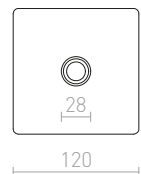
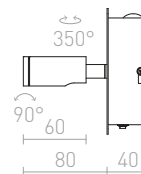

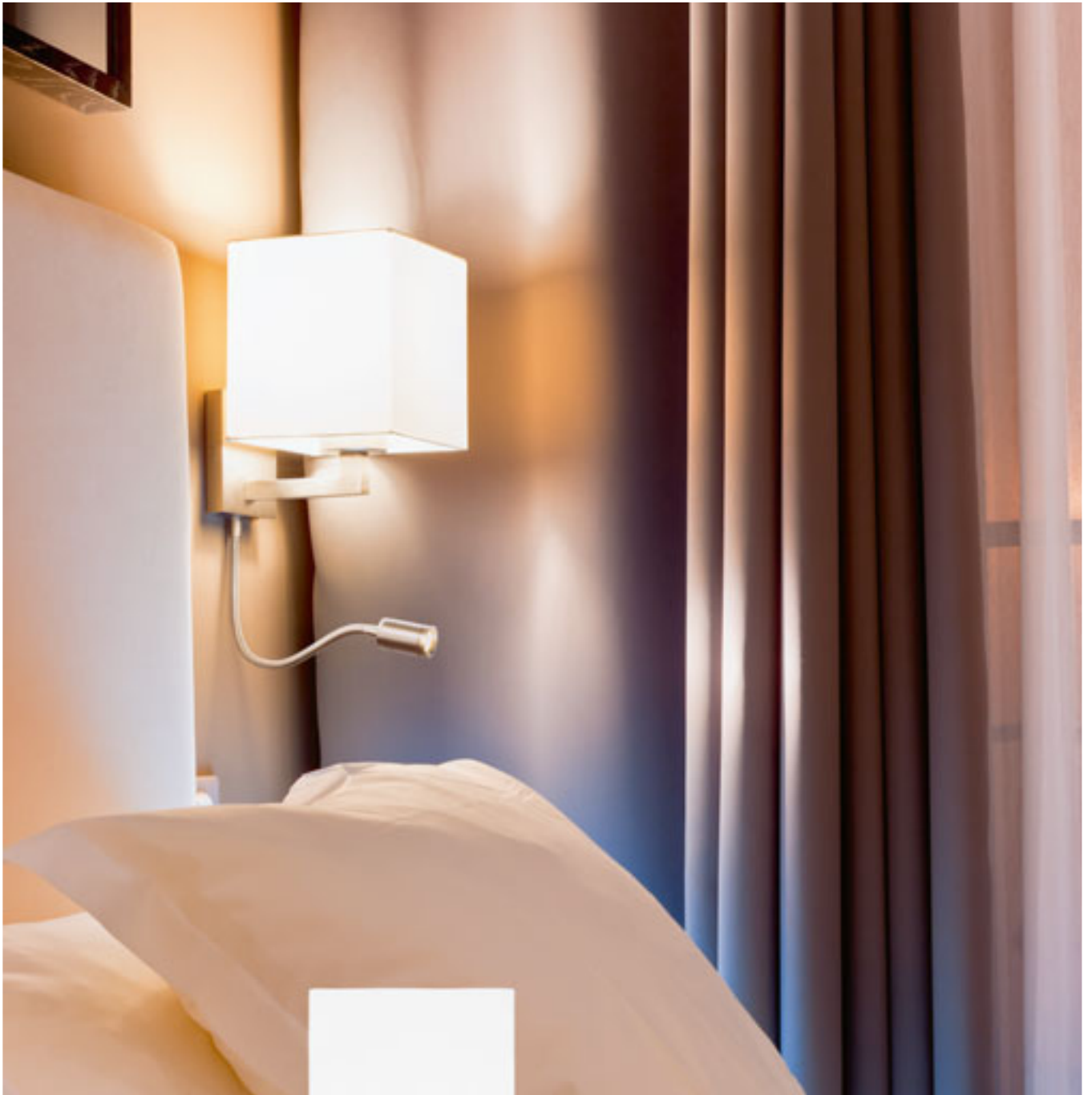

## TAINA

Luminária de parede com abajur têxtil e LED sobre braço flexível. As duas fontes de luz podem ser controladas individualmente por interruptores localizados na base da luminária.

### TAINA COM ABAJUR

230 V E27 LED 28 W+3 W  $\angle 25^\circ$  3000 K 180 lm Ra 80

R12956 branco/níquel mate

€ 138

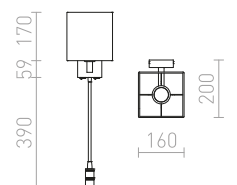



## MADISON

Luminária de teto com braço ajustável e um abajur têxtil.

### MADISON W NA PAREDE

230 V E27 42 W

R12480 branco/cromo

€ 420

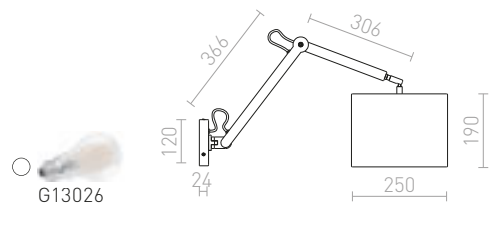

## ASHLEY

Luminária de parede com braço duplo, abajur têxtil e interruptor na base.

### ASHLEY NA PAREDE

230 V E27 42 W

R12482 branco/cromo

€ 435

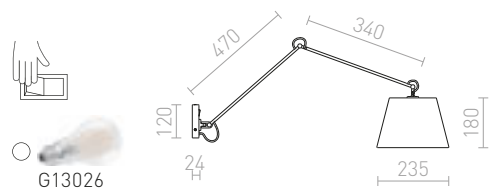
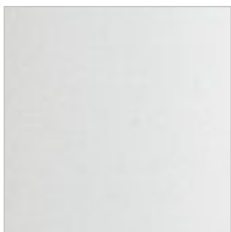









## MONTANA

Candeeiro de parede com braço ajustável e abajur têxtil.

### MONTANA NA PAREDE

230 V E27 28 W

R13282 branco/preto/cromo

€ 258



G13014

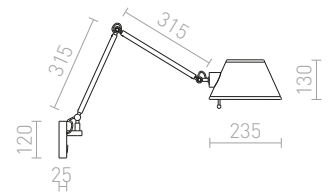

## ANTE

Candeeiro de parede, ideal para escritório, com braço ajustável e interruptor na base.

### ANTE NA PAREDE

230 V E27 28 W

R12651 preto/cobre

€ 98

R12652 branco/níquel mate

€ 98



G13026

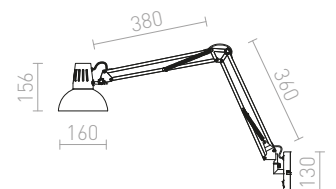



IP65

## GRANITA

Candeeiro de parede exterior em cimento, para fontes de luz LED com casquilho GU10.

### GRANITA II NA PAREDE

230 V LED GU10 2x5 W IP65

R13792 cimento/granito claro

€ 120

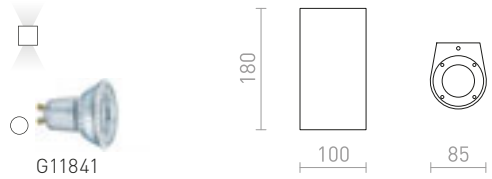

## GINA

Luminária de parede em gesso para fontes de luz com casquilho G9. A superfície pode ser pintada com tintas para interiores.

### GINA S PAREDE

230 V G9 33 W

R11959 gesso

€ 58

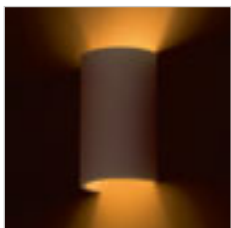
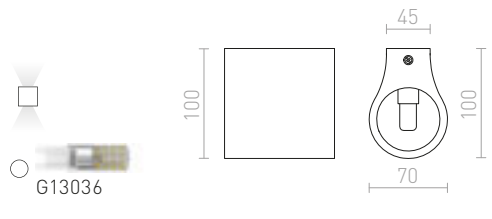

## CHIC

Aplique de gesso para iluminação bidirecional. A superfície pode ser pintada com tintas para interiores.

### CHIC NA PAREDE

230 V G9 25 W

R12999 gesso

€ 58

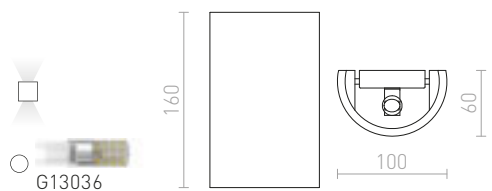

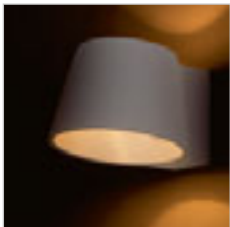

## BENITA

Aplique de gesso para fontes de luz E14. A superfície pode ser pintada com tinta de parede convencional.

### BENITA NA PAREDE

230 V E14 25 W

R13520 gesso

€ 88

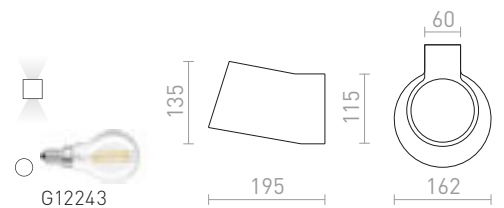

## BODIE

Luminária com LED integrado para iluminação bidirecional. A superfície pode ser pintada com tintas para interiores. Inclui um driver embutido.

### BODIE NA PAREDE

230 V LED 2x3 W 3000 K 480 lm Ra 80

R13433 gesso

€ 120

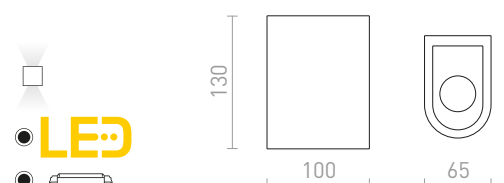



## GAN

Luminária de gesso de parede com iluminação bidirecional. A superfície pode ser pintada com tintas para interiores.

### GAN NA PAREDE

230 V G9 33 W

R12039 gesso

€ 78



## COWLEY

Luminária de gesso de parede com iluminação bidirecional. A parte inferior tem uma cobertura de vidro acetinado. A superfície pode ser pintada com tintas para interiores.

### COWLEY NA PAREDE

230 V G9 2x28 W

R13435 gesso

€ 88

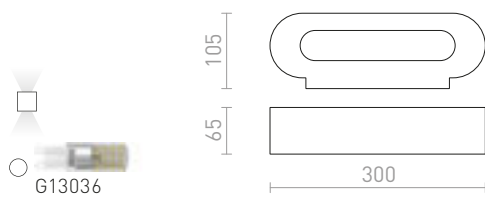

## VERITA

Luminária de gesso redonda com luz bidirecional e fonte de luz E27. A superfície pode ser pintada com tintas para interiores.

### VERITA NA PAREDE

230 V E27 33 W

R12365 gesso

€ 120







## CRESCENT

Aplique de gesso com iluminação bidirecional. O fundo tem uma cobertura de vidro acetinado. A superfície pode ser pintada com tintas para interiores.

### CRESCENT L NA PAREDE

230 V E14 2x28 W

R10451 gesso

€ 129

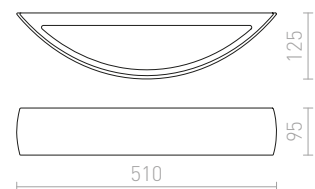

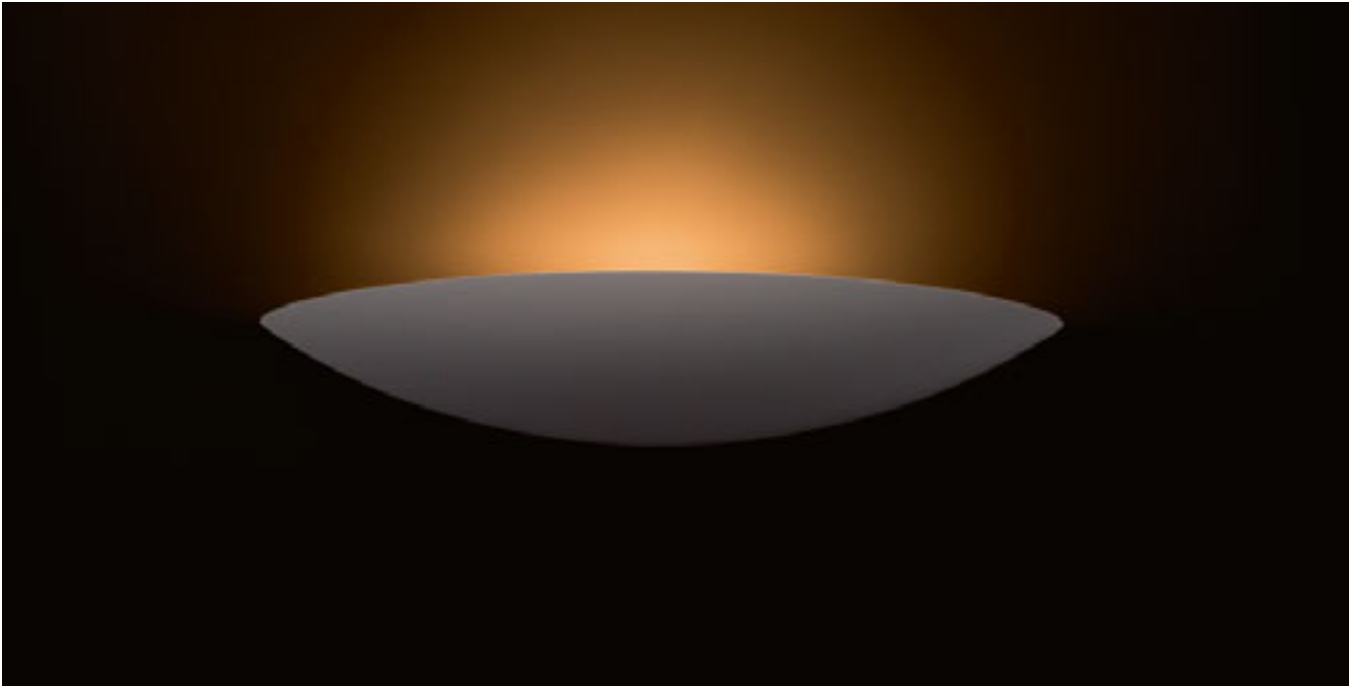

## SID

Luminária de gesso para iluminação indireta. A luminária pode ser pintada com tintas para interiores.

### SID NA PAREDE

230 V R7s 78mm 48 W

R12998 gesso

€ 88

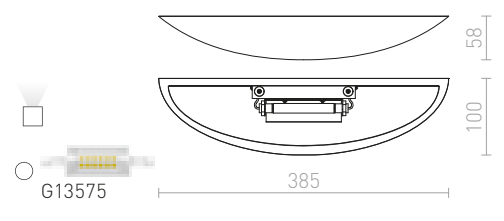

## CRESCENT

Aplique de gesso com iluminação bidirecional. O fundo tem cobertura de vidro acetinado. Para uma fonte de luz de halogéneo linear de 78 mm. A superfície pode ser pintada com tintas para interiores.

### CRESCENT NA PAREDE

230 V R7s 78mm 80 W

R10266 gesso

€ 88

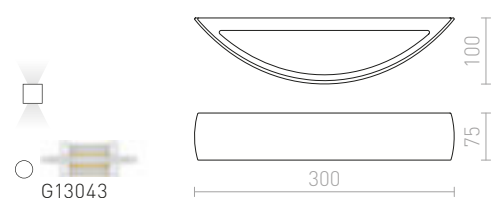



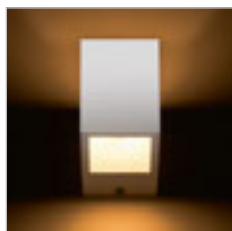

## JACK

Luminária de parede em gesso bidirecional. A superfície pode ser pintada com tintas para interiores.

### JACK SQ NA PAREDE

230 V G9 40 W

R10445 gesso

€ 58

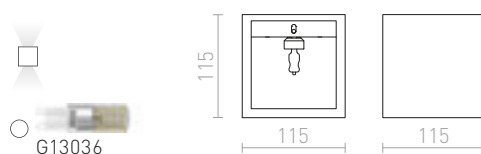

### JACK RC S NA PAREDE

230 V G9 33 W

R11960 gesso

€ 48

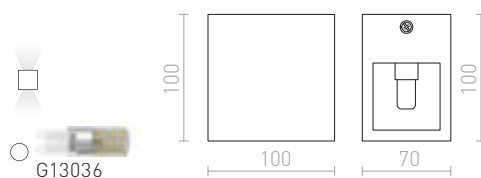

## HAY

Aplique em gesso. A superfície pode ser pintada com tintas para interiores.

### HAY NA PAREDE

230 V G9 40 W

R10448 gesso

€ 48 %

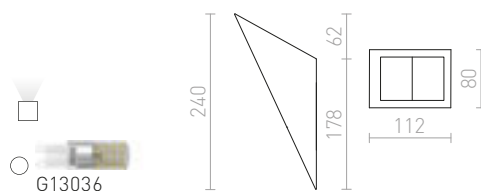



## KUBIS

Luminária de parede em gesso com forma assimétrica. Deve ser instalada com a abertura estreita apontando para cima. A superfície pode ser pintada com tinta de parede convencional. Dimensões da base A/L/P 10/5/2 cm, dimensões das aberturas D1/A1 10/5.5 cm, A2/L2 7/8 cm.

### KUBIS NA PAREDE

230 V G9 40 W

R10455 gesso

€ 48

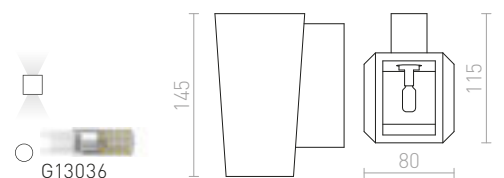



## WIM

Aplique em gesso que pode ser pintado com tintas para interiores.

### WIM NA PAREDE

230 V G9 2x40 W

R10465 gesso

€ 68

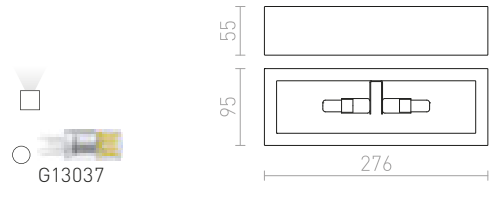

## ROLO

Luminária bidirecional de gesso. A parte inferior tem uma cobertura de vidro acetinado. A superfície pode ser pintada com tintas para interiores.

### ROLO 45 NA PAREDE

230 V E14 2x11 W

R13436 gesso

€ 120

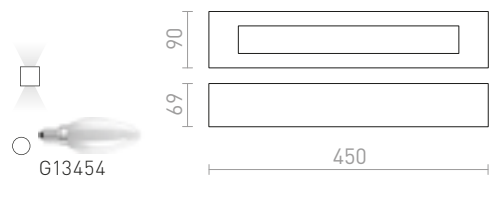

### ROLO 36 NA PAREDE

230 V E14 2x30 W

R10446 gesso

€ 68

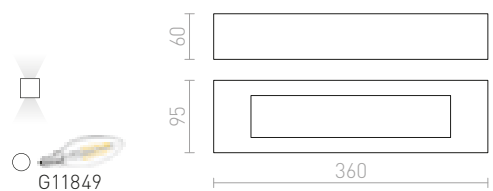





## FOND

Aplique retangular com LED integrado para iluminação indireta.

### FOND NA PAREDE

230 V LED 12 W 3000 K 1300 lm Ra 80

R12596 branco

€ 120

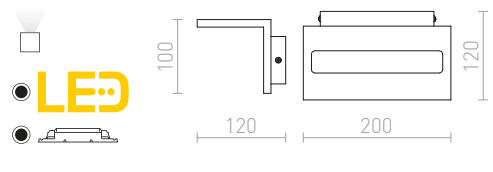

## BRUXEL

Luz montada na parede com design elegante e LED integrado para iluminação indireta.

### BRUXEL 12 NA PAREDE

230 V LED 6 W 3000 K 650 lm Ra 80

R13842 branco

€ 88 **NEW**

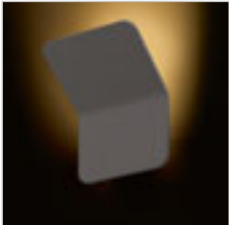
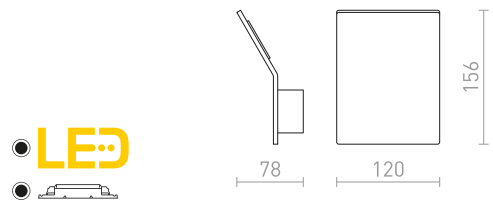

## ATLANTA

Luminária de parede circular com LED integrado para uma iluminação indireta que reflete a luz na parede. Adequada para uso interior e exterior.

### ATLANTA 13 DE SUPERFÍCIE

230 V LED 6 W 3000 K 780 lm Ra 80 IP54

R12825 branco

€ 78

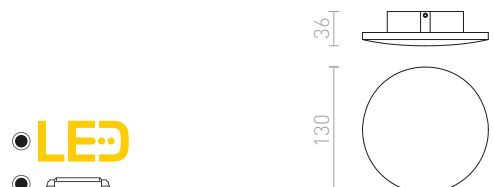



## VIENNA

Luminária LED de parede quadrada com cantos arredondados e LED integrado para iluminação indireta refletindo a luz da parede.

### VIENNA DE SUPERFÍCIE

230 V LED 9 W 3000 K 1300 lm Ra 80

R12589 branco

€ 88 %

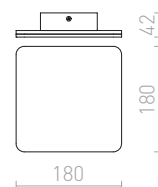

IP54

## ATHI

Luminária de parede quadrada com LED integrado para uma iluminação indireta refletindo a luz na parede. Adequada para uso interior e exterior.

### ATHI NA PAREDE

230 V LED 9,6 W 3000 K 550 lm Ra 80 IP54

R12551 branco

€ 120

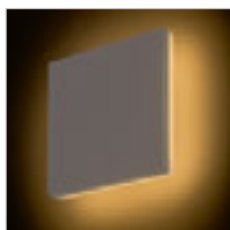
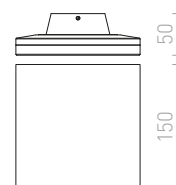



IP65



IP65

## TITO

Luminária de parede LED para iluminação direcional com possibilidade de configurar o feixe de luz. Regulação da intensidade da luz TRIAC.

### TITO R DIMM NA PAREDE

230 V LED 2x3 W 3000 K 500 lm Ra 80 IP65

R13736 branco

€ 88

R13737 preto

€ 88

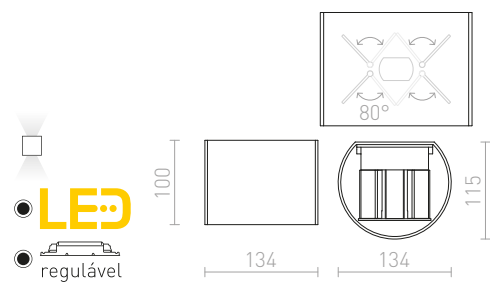

### TITO SQ DIMM NA PAREDE

230 V LED 2x3 W 3000 K 500 lm Ra 80 IP65

R13738 branco

€ 88

R13739 preto

€ 88

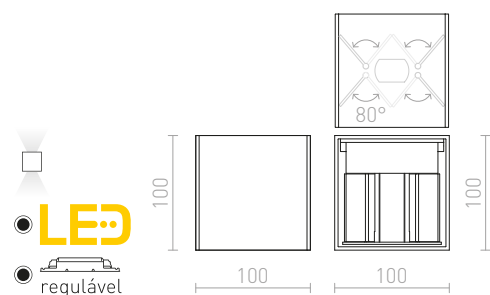



IP54

### CARRE

Luminária de parede angular com LED integrado para iluminação bidirecional, com possibilidade de configurar feixe de luz.

#### CARRE NA PAREDE

230 V LED 2x3 W 3000 K 200 lm Ra 80 IP54

R12556 branco

€ 88

R12557 cinzento antracite

€ 88

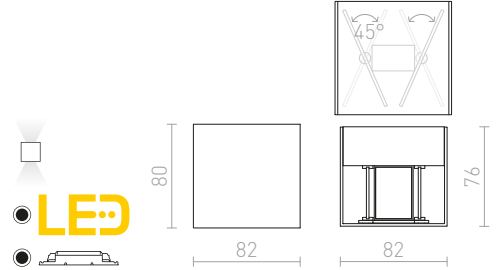

IP54

### TITO

Luminária de parede LED para iluminação bidirecional com possibilidade de configurar o feixe de luz.

#### TITO SQ NA PAREDE

230 V LED 6 W 3000 K 500 lm Ra 80 IP54

R12601 alumínio escovado

€ 78

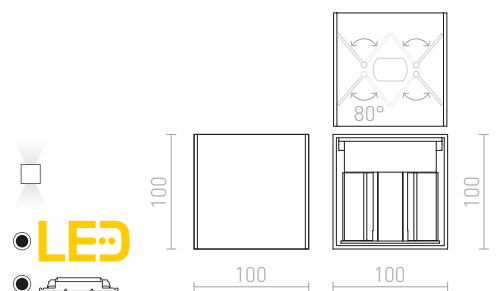





## DAFFY

Luminária arredondada com LED integrado para iluminação bidirecional.

### DAFFY NA PAREDE

230 V LED 6 W 3000 K 780 lm Ra 80

R12592 branco

€ 98

R12593 preto

€ 98





IP54



## MIDZACK

Aplique arredondado com LED integrado para iluminação bidirecional.

### MIDZACK NA PAREDE

230 V LED 2x3 W 3000 K 480 lm Ra 80 IP54

R12585 branco

€ 88

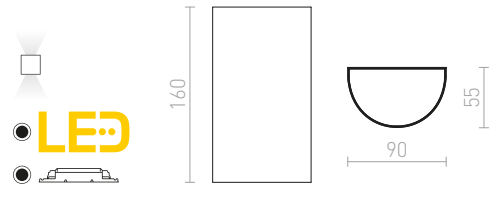

## BIARITZ

Luminária circular LED de parede para iluminação bidirecional.

### BIARITZ NA PAREDE

230 V LED 5 W 3000 K 780 lm Ra 80

R12606 branco

€ 68

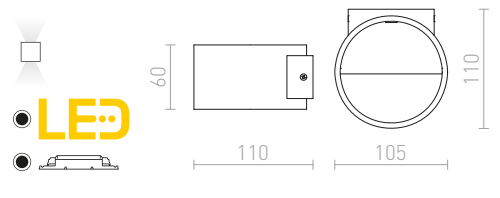

## TUBA

Luminária de parede metálica cilíndrica com iluminação bidirecional e casquilho G9.

### TUBA W NA PAREDE

230 V G9 33 W

R12739 mate branco

€ 48

R12740 mate preto/ouro

€ 48

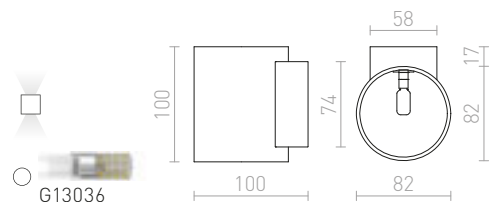



IP54

## MICO

Aplique de alumínio fundido com foco fixo para iluminação unidirecional.

**MICO I EXTERIOR**  
230 V GU10 35 W IP54

**R10170** alumínio

€ 58

%



G11837

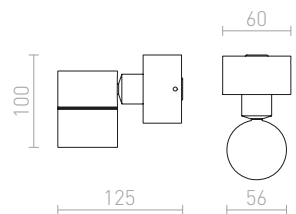



### MICO

Aplique pequeno com iluminação bidirecional feito de alumínio polido para fontes de luz de halógeno.

#### MICO II NA PAREDE

230 V G9 2x25 W

R10129 alumínio

€ 68 %

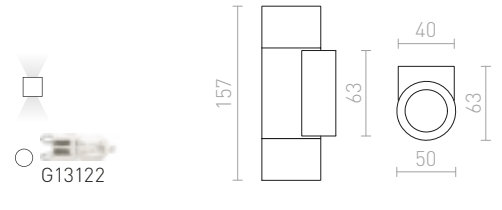

IP54

### MOIRE

Aplique de alumínio natural com coberturas de vidro.

#### MOIRE I EXTERIOR

230 V GU10 35 W IP54

R10133 alumínio

€ 48 %

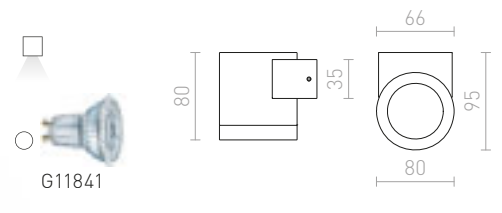

IP54

#### MOIRE II EXTERIOR

230 V G9 25 W IP54

R10132 alumínio

€ 68 %

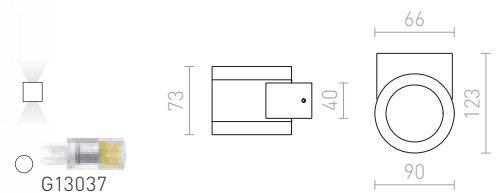

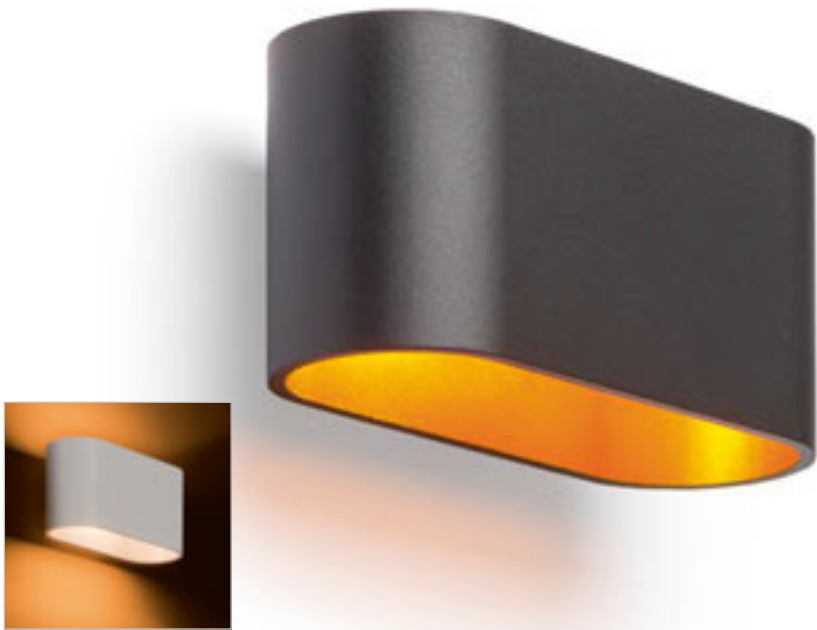

## MARIO

Luminária metálica oval com iluminação bidirecional e casquilho G9.

### MARIO

230 V G9 33 W

**R12743** mate branco

€ 58

**R12744** mate preto/ouro

€ 68

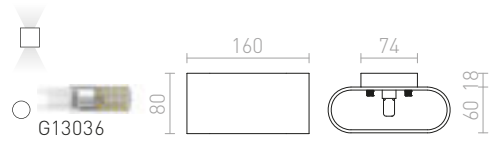

## ROZA

Aplique bidirecional de cantos arredondados com LED integrado.

### ROZA NA PAREDE

230 V LED 6 W 3000 K 315 lm Ra 80

**R12575** branco

€ 58

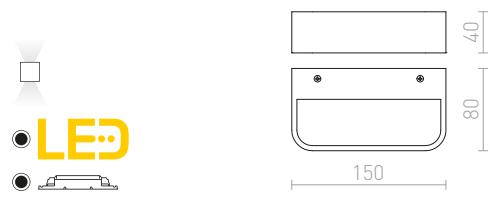

## NAXOS

Aplique com forma de arco e LED integrado para iluminação bidirecional.

### NAXOS NA PAREDE

230 V LED 6 W 3000 K 780 lm Ra 80

**R12590** branco

€ 120 %

**R12591** metal escovado

€ 120 %

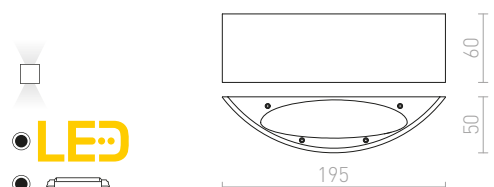



### TAPA

Luminária de parede retangular para exterior em metal lacado, bidirecional LED.

#### TAPA NA PAREDE

230 V LED 6 W 3000 K 277 lm Ra 80 [IP54](#)

R13562 branco

€ 68

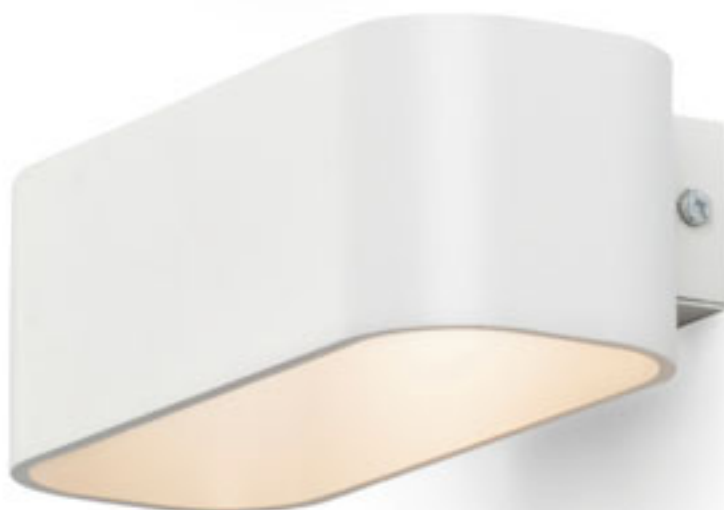
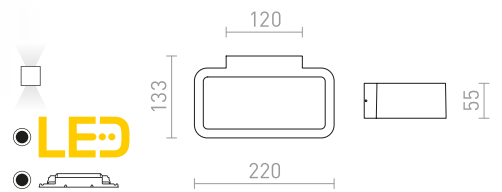

### REEM

Aplique com LED integrado de alumínio lacado para iluminação bidirecional.

#### REEM NA PAREDE

230 V LED 4,5 W 3000 K 300 lm Ra 80

R10401 branco

€ 98

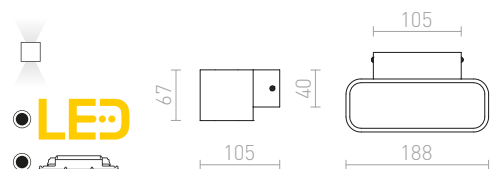



## TRIP

Luminária de parede retangular de metal com iluminação bidirecional e casquilho G9.

### TRIP SQ NA PAREDE

230 V G9 33 W

**R12741** mate branco

**€ 38**

**R12742** mate preto/ouro

**€ 48**

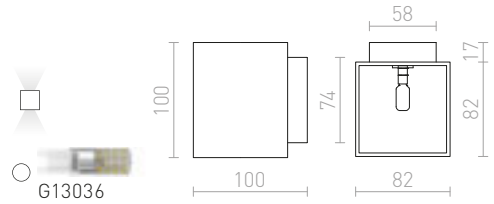

## DIDO

Luminária retangular de alumínio lacado a branco com LED de alta potência para iluminação bidirecional.

### DIDO NA PAREDE

230 V/500 mA LED 4,5 W 3000 K 250 lm Ra 80

**R10400** branco

**€ 98**

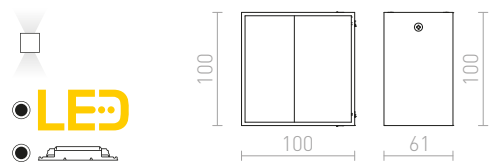

## ESSEX

Luminária metálica quadrada de parede para fonte de luz com casquilho G9 e iluminação bidirecional.

### ESSEX NA PAREDE

230 V G9 33 W

**R12679** mate branco

**€ 35**

**R12680** alumínio escovado

**€ 35**

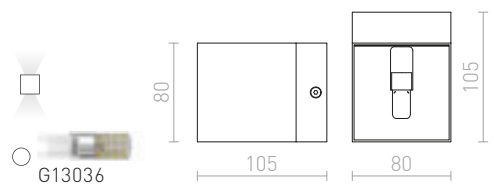



## KORSO

Aplique com LED integrado para interiores e exteriores. Feito de alumínio com acabamento anodizado natural ou preto escovado.

### KORSO II NA PAREDE

230 V LED 2x3 W  $\angle 120^\circ$  3000 K 780 lm Ra 80 IP54

R12831 alumínio escovado

€ 68 %

R12832 anodizado negro

€ 68 %

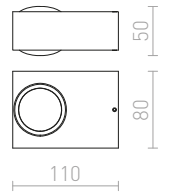
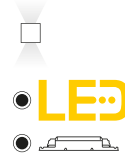

## PEKKO

Aplique retangular para exteriores com LED integrado para iluminação unidirecional.

### PEKKO NA PAREDE

230 V LED 3 W  $\angle 67^\circ$  3000 K 86 lm Ra 80 IP54

R12552 branco

€ 78

R12553 preto

€ 78

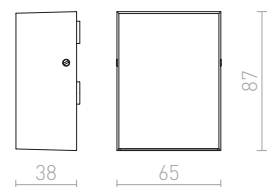
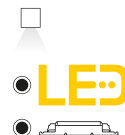

IP54



## ONYX

Luminária de parede cúbica com LED integrado, cantos arredondados e uma superfície de reflexão estruturada para iluminação bidirecional.

### ONYX NA PAREDE

230 V LED 5 W 3000 K 500 lm Ra 80

R12598 branco

€ 68

R12599 preto

€ 68

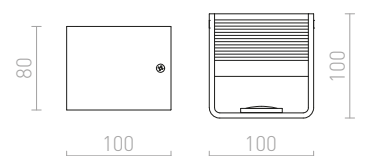
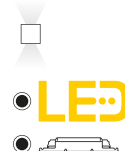



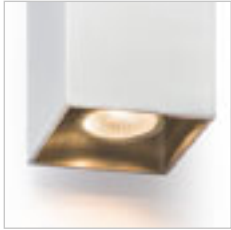

## AGATE

Luminária quadrada metálica de parede com iluminação bidirecional para duas fontes de luz refletoras GU10.

### AGATE II NA PAREDE

230 V GU10 2x35 W

R12677 mate branco

€ 68

R12678 alumínio escovado

€ 48

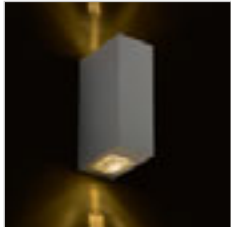
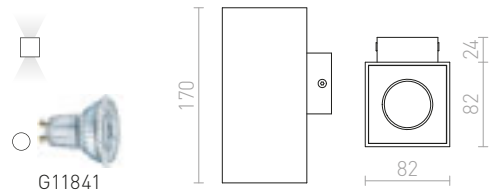

IP54

## NICK

Aplique com LED integrado e iluminação bidirecional adequado para interiores e exteriores.

### NICK II NA PAREDE

230 V LED 2x3 W  $\angle 10^\circ$  3000 K 780 lm Ra 80 IP54

R12827 alumínio escovado

€ 68

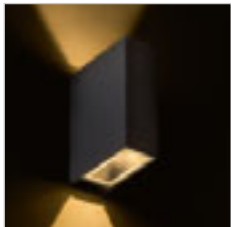
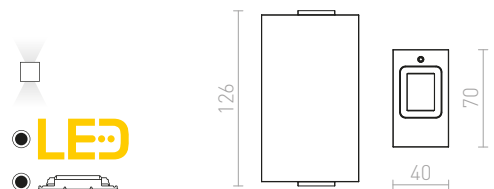

IP54

## UKKO

Aplique retangular para exteriores com LED integrado, para iluminação bidirecional.

### UKKO NA PAREDE

230 V LED 2x3 W  $\angle 55^\circ$  3000 K 180 lm Ra 80 IP54

R12555 preto

€ 120

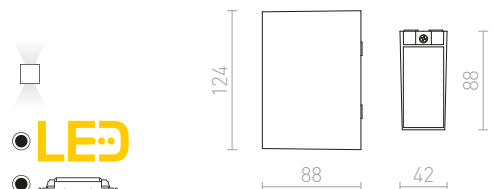



IP44

### DESMOND

Candeeiro de parede em alumínio para exterior com iluminação bidirecional para duas fontes de luz LED com casquilho GU10.

#### DESMOND II NA PAREDE

230 V GU10 2x35 W IP44

**R13609** branco € 68

**R13610** cinzento prata € 68

**R13611** cinzento antracite € 68



G11841

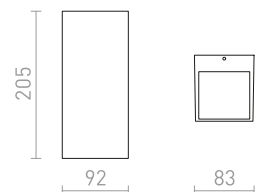

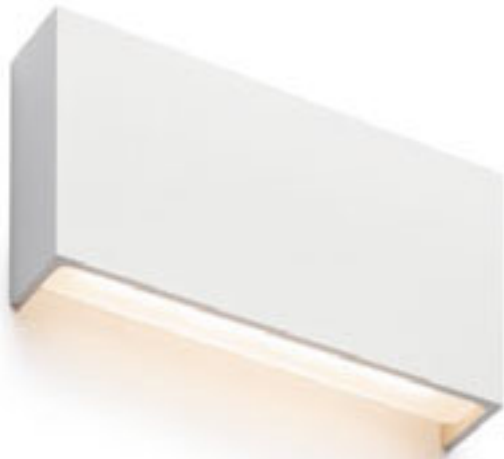

IP54



## TORINO

Luminária LED retangular de parede com iluminação bidirecional.

### TORINO NA PAREDE

230 V LED 2x5 W 3000 K 550 lm Ra 80 IP54

R12573 branco

€ 129

R12574 preto

€ 129



LED

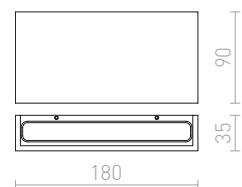

**LEA**

Luminária de parede LED retangular para iluminação bidirecional.

**LEA NA PAREDE**

230 V LED 6 W 3000 K 650 lm Ra 80

R12587 branco

€ 68 %

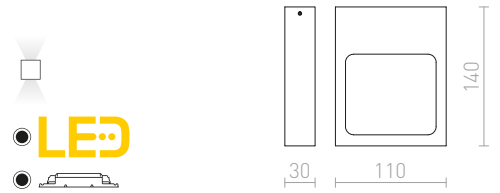
**NEMAN**

Luminária de parede angular com LED integrado para iluminação bidirecional.

**NEMAN NA PAREDE**

230 V LED 10 W 3000 K 1300 lm Ra 80

R12595 preto

€ 120

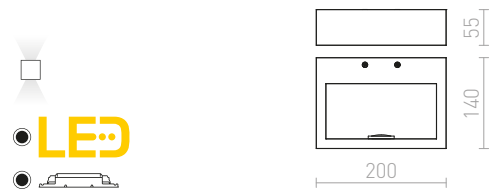
**CHLOE**

Aplique retangular em aço inoxidável, para iluminação indireta de uso interior ou exterior.

**CHLOE NA PAREDE**

230 V LED 9 W 3000 K 800 lm Ra 80 IP65

R11752 aço inoxidável

€ 120

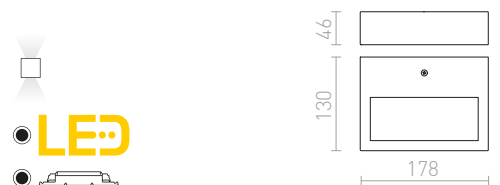

IP65



## PRIO LED

Luminária de parede em alumínio com LED integrado, para iluminação bidirecional. Disponível em duas cores. O aplique não pode ser usado como prateleira!

### PRIO LED 62 NA PAREDE

230 V LED 33 W 3000 K 720 lm Ra 80

R12091 branco

€ 178

%

R12092 alumínio escovado

€ 178

%



LED

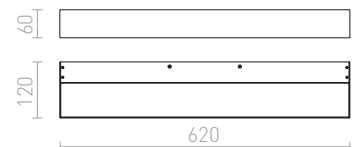



IP65

### TWIST

Iluminação LED de parede em alumínio para exterior que pode ser rodada para obter uma iluminação ascendente ou descendente.

#### TWIST NA PAREDE

230 V LED 12 W 3000 K 980 lm Ra 80 IP65

R13615 branco

€ 98

R13616 cinzento antracite

€ 98

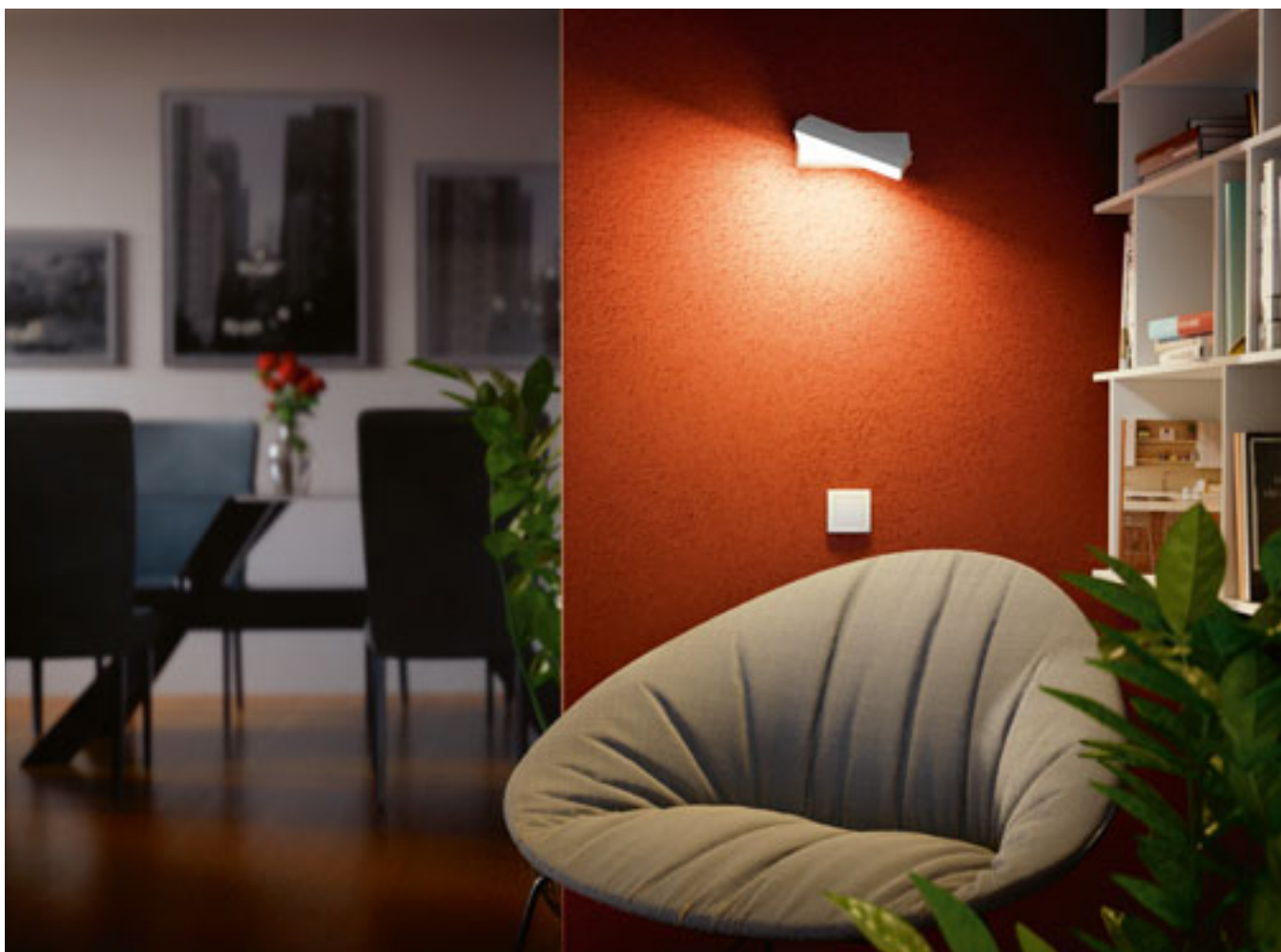
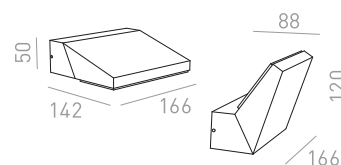



## SWING

Luminária LED linear adequada para iluminar quadros.

### SWING TOPO DE QUADRO

230 V LED 8 W 3000 K 750 lm Ra 80

R12954 cromo

€ 138

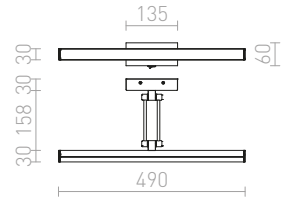
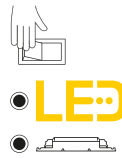

IP44

## SWAY

Luminária LED linear inclinável, ideal acima de espelhos ou quadros.

### SWAY CASA DE BANHO

230 V LED 12 W 3000 K 1060 lm Ra 80 IP44

R12951 cromo

€ 120

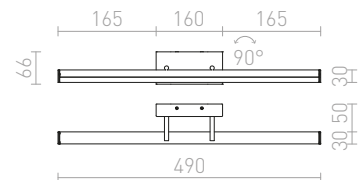

IP44

## PANON

Luminária LED linear sobre braço fixo com LED integrado para iluminação descendente. Adequada para ambientes húmidos.

### PANON LONG NA PAREDE

230 V LED 12 W 3000 K 900 lm Ra 80 IP44

R12950 cromo

€ 120

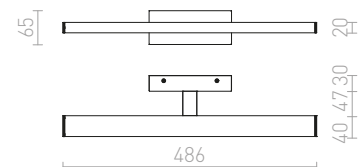
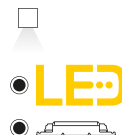





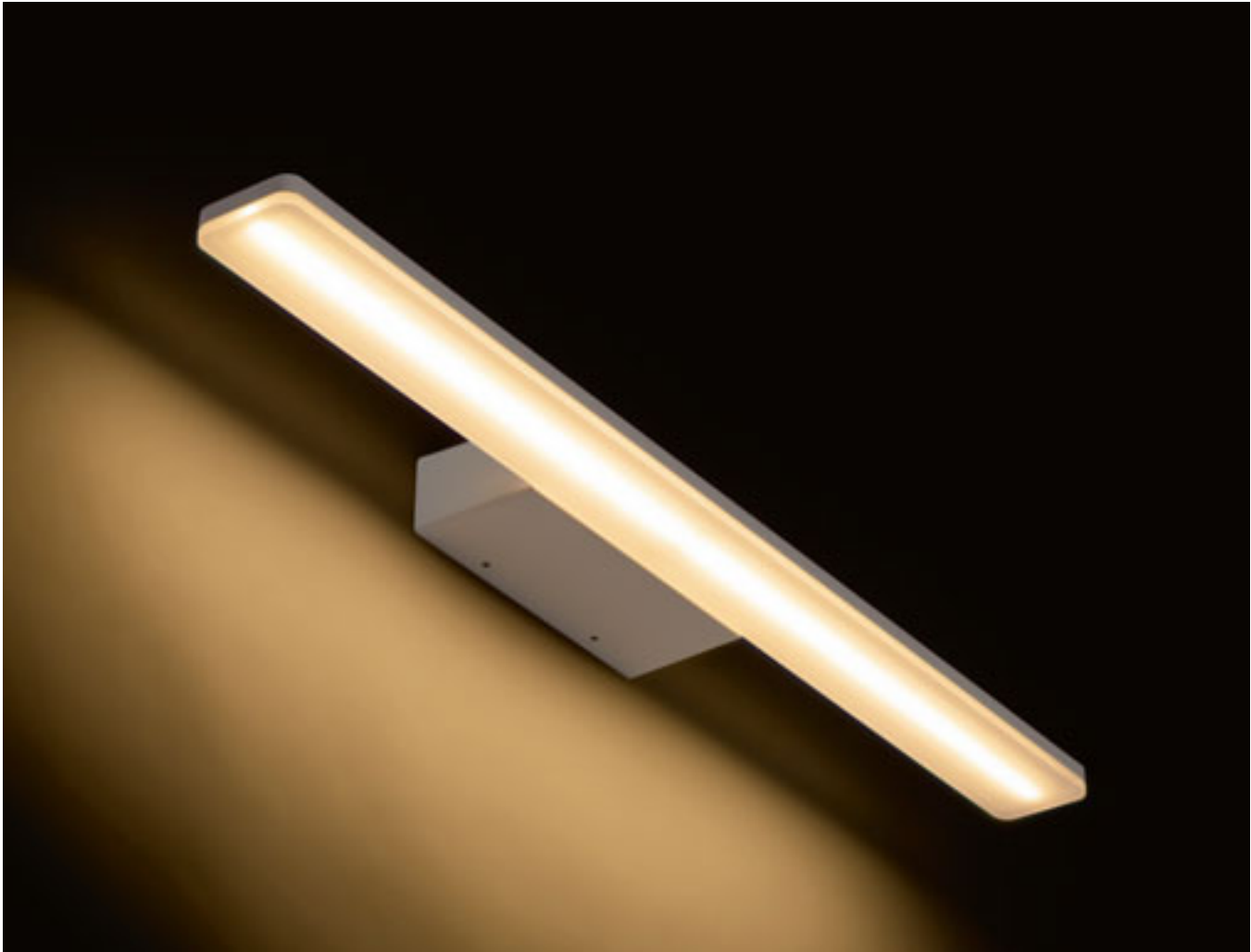

IP44



## MAREA

Luminária linear LED com iluminação descendente, adequada para colocar acima do espelho. Para uso em ambientes húmidos.

### MAREA 60 NA PAREDE

230 V LED 18 W 3000 K 1954 lm Ra 80 IP44

R13554 branco

€ 188

R13852 preto

€ 188

NEW

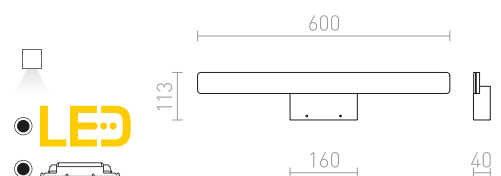



IP44

**IMPERISO**

Luminária linear LED adequada para colocar acima de espelho. A frente pode girar no eixo horizontal. Para uso em ambientes húmidos.

**IMPERISO 60**

230 V LED 18 W 3000 K 1769 lm Ra 80 IP44

R13555 branco

€ 248

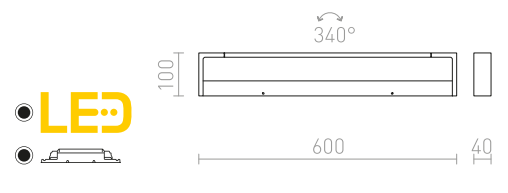

IP54

**LUISA**

Luminária linear LED com iluminação descendente, adequada para colocar acima do espelho. Para uso em ambientes húmidos.

**LUISA 60 NA PAREDE**

230 V LED 12 W 3000 K 1138 lm Ra 80 IP54

R13735 branco

€ 150

R13853 preto

€ 150

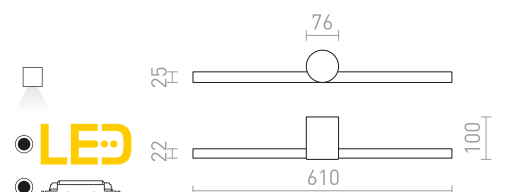

NEW



IP44



IP44



### FLORIO

Luminária LED indicada para casa de banho, com ficha integrada para aparelhos de baixo consumo até 100W.

#### FLORIO 49 PAREDE

230 V LED 8W 3000 K 640 lm Ra 80 IP44

R12903 branco

€ 88

R12904 cromo

€ 98



LED

55



480

65



IP44



IP44



### CORAZON

Luminária linear com LED integrado, adequada para ambientes húmidos.

#### CORAZON 60

230 V LED 15W 3000 K 1200 lm Ra 80 IP44

R12901 cromo

€ 78



LED

51



600

70



#### CORAZON 90

230 V LED 20W 3000 K 1600 lm Ra 80 IP44

R12902 cromo

€ 120



LED

51



900

70







## TICO

Luminária em alumínio maciço de feixe único para montagem à superfície.

### TICO I NA PAREDE

230 V LED 3 W 3000 K 190 lm Ra 80

R10178 alumínio

€ 38 %

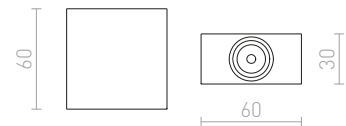
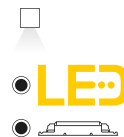



IP54

**AMBER**

Aplique LED circular de parede para iluminação de orientação. Não precisa de ser encastrado

**AMBER NA PAREDE**

230 V LED 3 W 3000 K 130 lm Ra 80

R12610 cinzento

€ 48 %

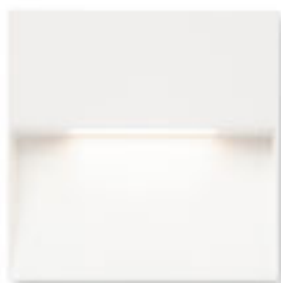
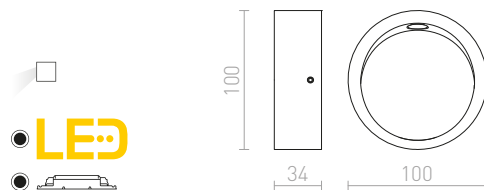
**AQILA**

Aplique com LED integrado para iluminação de orientação de pavimentos, escadas ou terraços. Adequado para exterior e interior sem a necessidade de ser embutido.

**AQILA SQ NA PAREDE**

230 V LED 6 W 3000 K 200 lm Ra 80 IP54

R12542 branco

€ 88

R12544 cinzento antracite

€ 88

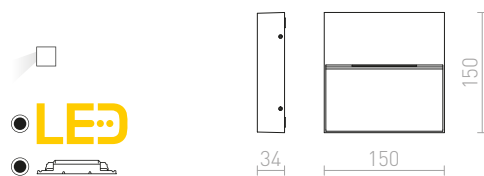

IP54

**AQILA RC NA PAREDE**

230 V LED 6 W 3000 K 200 lm Ra 80 IP54

R12545 branco

€ 88 →

R12547 cinzento antracite

€ 98

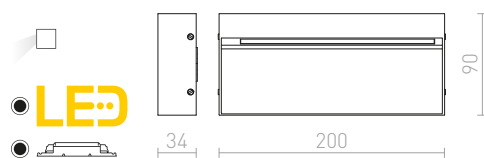

IP54

**AQILA R NA PAREDE**

230 V LED 6 W 3000 K 200 lm Ra 80 IP54

R12539 branco

€ 88

R12540 cinzento

€ 78 →

R12541 cinzento antracite

€ 88

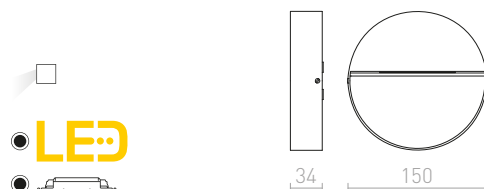

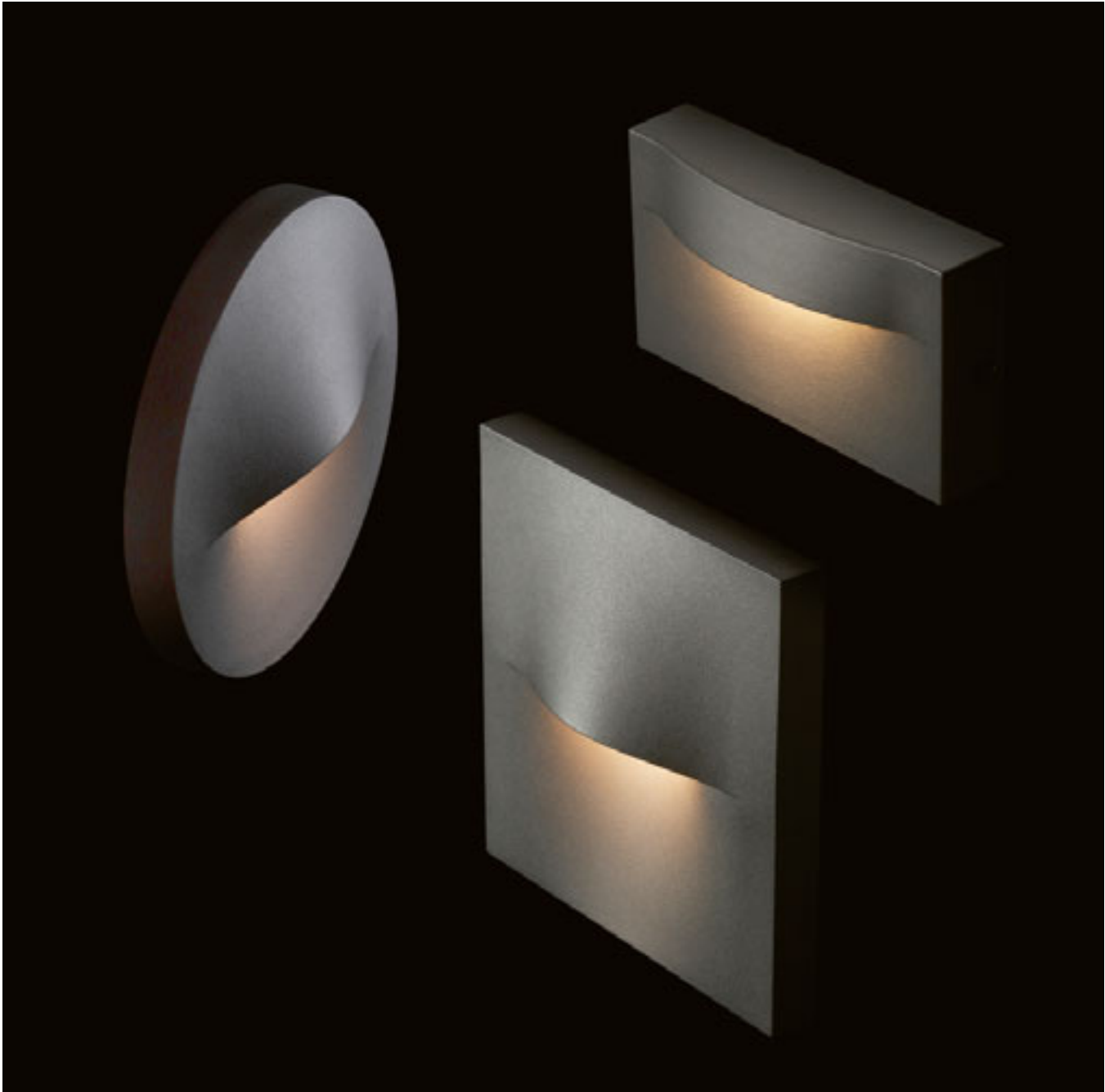

IP65



## BOBO

Lâmpada LED de alumínio saliente para uso exterior, adequada para iluminação de caminhos e escadas, sem necessidade de embutir.

### BOBO R NA PAREDE

230 V LED 3 W 3000 K 212 lm Ra 80 IP65

R13933 cinzento antracite

€ 48

NEW

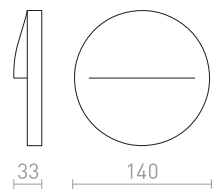
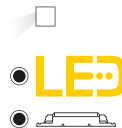



IP65

**BOBO**

Lâmpada LED de alumínio saliente para uso exterior; adequada para iluminação de caminhos e escadas, sem necessidade de embutir.

**BOBO RC NA PAREDE**

230V LED 8W 3000K 640lm Ra80 IP65

R13934 cinzento antracite

€ 58

NEW

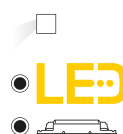

IP65

**BOBO**

Lâmpada LED de alumínio saliente para uso exterior; adequada para iluminação de caminhos e escadas, sem necessidade de embutir.

**BOBO SQ NA PAREDE**

230V LED 3W 3000K 135lm Ra80 IP65

R13935 cinzento antracite

€ 48

NEW

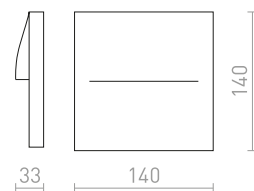
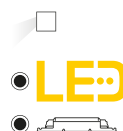





## FOCOS

CASA DE BANHO	272-275
PARA CAMA	276-285
CONJUNTOS	286-303
EM BRAÇO ARTICULADO	304-309
INCLINÁVEIS	310-317

## FOCOS CASA DE BANHO



**LINN I**  
272-273



**LINN III**  
272-273



**VALTO I**  
272-273

272-275



**VALTO III**  
272-273



**BOLLY III**  
272-273



**DUBLIN I**  
274-275



**DUBLIN II**  
274-275



**DUBLIN III**  
274-275



**DUBLIN IV**  
274-275

## FOCOS PARA CAMA



**VERSA**  
276-277



**VERSINA**  
276-277



**TAINA**  
276-277

276-285



**PERTH**  
276-277



**CHOUPETTE**  
278-279



**ARAQ**  
278-279



**HAREN**  
278-279



**ROSTAM**  
278-279



**VIPER WL**  
280-281



**TIARA**  
280-281



**FADO I**  
280-281



**MIG**  
280-281



**TAPIRO I SQ**  
280-281



**AMADEUS I**  
282-283



**STIG**  
282-283



**THALIA**  
282-283



**VOLTERA USB**  
284-285



**SIENA**  
284-285



**ELISEO**  
284-285

## FOCOS CONJUNTOS



**BOGARD I**  
286-287



**BOGARD II**  
286-287



**BOGARD III**  
286-287

286-303



**KENNY I**  
288-289



**KENNY II**  
288-289



**KENNY III**  
288-289



**KENNY IV**  
288-289



**KENNY**  
288-289



**DUDE R**  
290-291



**DUDE SQ**  
290-291



**DUDE**  
290-291



**DUDE II**  
290-291



**DUGME I**  
292-293



**DUGME II**  
292-293



**DUGME III**  
292-293



**TRICA I**  
294-295



**TRICA II**  
294-295



**TRICA III**  
294-295



**KELLY LED I**  
296-297



**KELLY LED II**  
296-297



**KELLY LED III**  
296-297



**KELLY LED**  
296-297



**KELLY LED I**  
298-299



**KELLY LED II**  
298-299



**KELLY LED III**  
298-299



**ELISEO**  
300-301



**ELISEO II**  
300-301



**GLOSSY**  
302-303



**GLOSSY I**  
302-303



**GLOSSY III**  
302-303



**ROSITA I**  
302-303



**ROSITA II**  
302-303

## FOCOS EM BRAÇO ARTICULADO

304-309



**AIM**  
304-305



**FRISCO W**  
304-305



**EKE**  
304-305



**POINT**  
306-307



**VERSA**  
306-307



**SHOW**  
306-307



**BOB**  
306-307



**KAYA**  
308-309



**FLAP**  
308-309



**VALE**  
308-309

## FOCOS INCLINÁVEIS



**CELEIA**  
310-311



**AGNETA**  
310-311



**BAROQUE**  
310-311

310-317



**JOLI I**  
310-311



**BELENOS**  
312-313



**BOGARD**  
312-313



**BOGARD TWIN**  
312-313



**OPTIMUS**  
312-313



**DARIO**  
314-315



**DARIO**  
314-315



**PIXIE**  
314-315



**ORIT**  
314-315



**CASSIE**  
316-317



**BUGSY I**  
316-317



**REDO**  
316-317



**MARVEL II**  
316-317



IP44

## BOLLY

Luminária de parede ou teto com vidro opalino sobre base cromada. Adequado para ambientes húmidos.

### BOLLY III DE SUPERFÍCIE

230 V G9 LED 3x3 W IP44

R13691 vidro colorido opala/cromo

€ 129

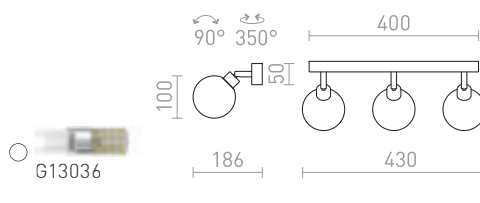

IP44

## LINN

Candeeiro de parede ou teto com vidro opalino e base cromada. Adequado para casas de banho.

### LINN I NA PAREDE

230 V G9 LED 3 W IP44

R13695 vidro colorido opala/cromo

€ 48

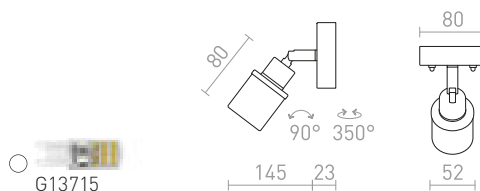

### LINN III DE SUPERFÍCIE

230 V G9 LED 3x3 W IP44

R13703 vidro colorido opala/cromo

€ 120

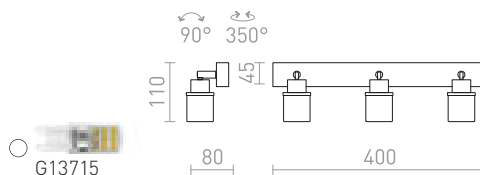



### VALTO

Luminária de parede ou teto com refletores inclináveis para fontes de luz LED com casquilho GU10. Adequado para casas de banho.

#### VALTO I NA PAREDE

230 V GU10 LED 5 W IP44

R13696 cromo

€ 48

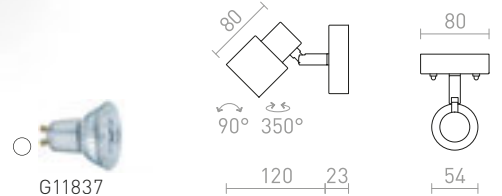

#### VALTO III DE SUPERFÍCIE

230 V GU10 LED 3x5 W IP44

R13704 cromo

€ 88

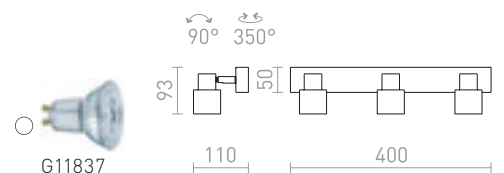







IP44



IP44



IP44



IP44

## DUBLIN

Foco cromado adequado para casas de banho.

### DUBLIN I DE SUPERFÍCIE

230 V GU10 9 W IP44

R13377 cromo

€ 48

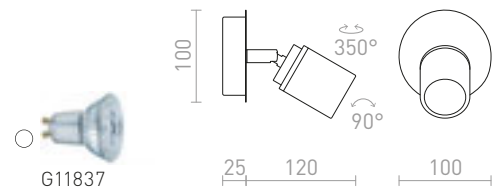

### DUBLIN II DE SUPERFÍCIE

230 V GU10 2x9 W IP44

R13378 cromo

€ 78

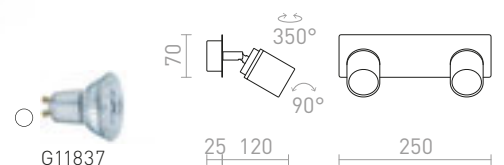

### DUBLIN III DE SUPERFÍCIE

230 V GU10 3x9 W IP44

R13379 cromo

€ 98

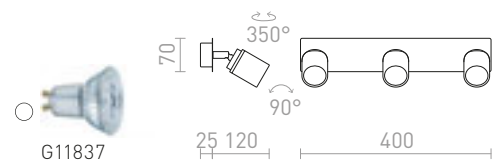

### DUBLIN IV DE SUPERFÍCIE

230 V GU10 4x9 W IP44

R13380 cromo

€ 129

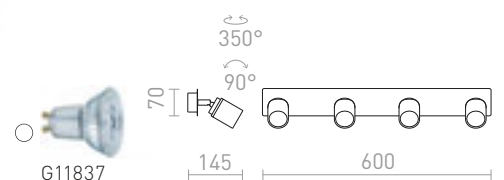

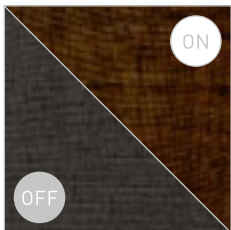
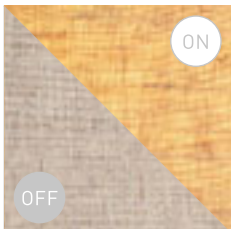

## PERTH

Candeeiro de parede com abajur quadrado em tecido complementado por braço flexível com refletor LED. O candeeiro possui duas fontes de luz, que podem ser controladas separadamente por um interruptor rotativo localizado na base quadrada do candeeiro.

### PERTH NA PAREDE COM FOCO LED

230 V E14 LED 15 W+3 W  $\angle 30^\circ$  3000 K 150 lm Ra 80

**R13661** bege/branco/cromo

€ 178

**R13662** preto/preto/cromo

€ 178



G13572

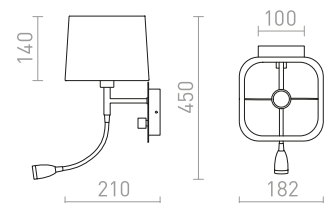



## VERSA

Luminária LED de parede com abajur têxtil e foco adicional com braço flexível. As duas fontes de luz podem funcionar separadamente com interruptores localizados na base.

### VERSA PAREDE COM ABAJUR

230 V E27 LED 42 W+3 W  $\angle 40^\circ$  3000 K 240 lm Ra 80

R10580 branco/níquel mate

€ 178

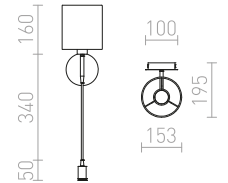
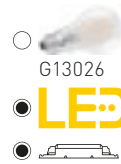

## VERSINA

Luminária de parede com abajur têxtil, complementada com foco LED sobre braço flexível. As duas fontes de luz podem funcionar separadamente com interruptores colocados na base.

### VERSINA COM ABAJUR

230 V E27 LED 28 W+3 W  $\angle 25^\circ$  3000 K 180 lm Ra 80

R12955 branco/cromo

€ 129

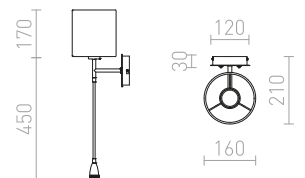

## TAINA

Luminária de parede com abajur têxtil e LED sobre braço flexível. As duas fontes de luz podem ser controladas individualmente por interruptores localizados na base da luminária.

### TAINA COM ABAJUR

230 V E27 LED 28 W+3 W  $\angle 25^\circ$  3000 K 180 lm Ra 80

R12956 branco/níquel mate

€ 138

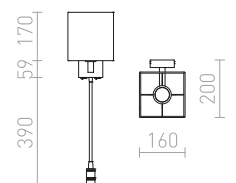

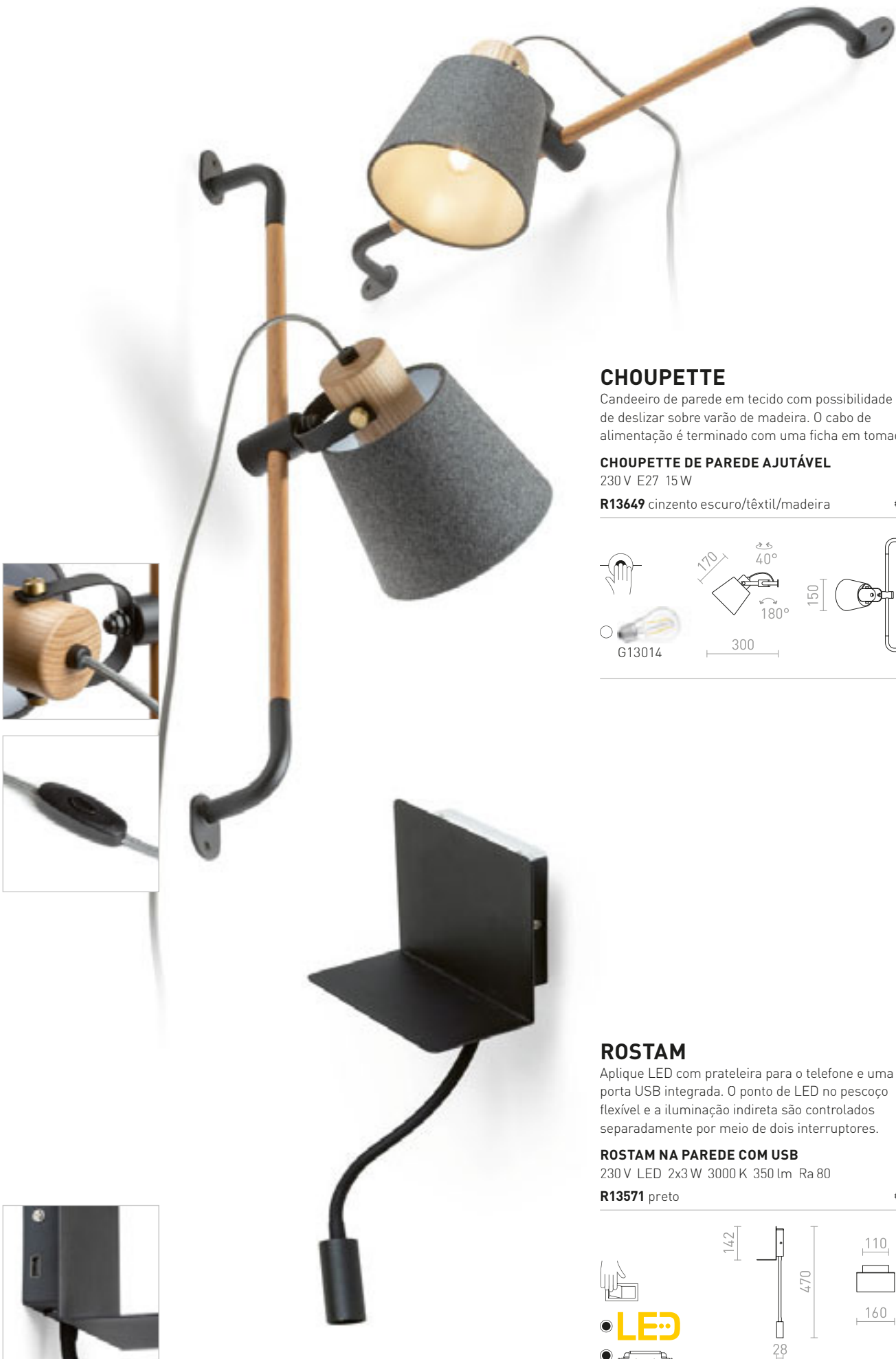

## CHOUPELLE

Candeeiro de parede em tecido com possibilidade de deslizar sobre varão de madeira. O cabo de alimentação é terminado com uma ficha em tomada.

**CHOUPELLE DE PAREDE AJUTÁVEL**  
230 V E27 15 W

**R13649** cinzento escuro/têxtil/madeira

**€ 215**

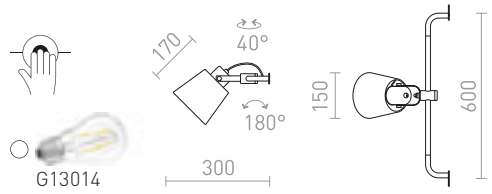

## ROSTAM

Aplique LED com prateleira para o telefone e uma porta USB integrada. O ponto de LED no pescoço flexível e a iluminação indireta são controlados separadamente por meio de dois interruptores.

**ROSTAM NA PAREDE COM USB**

230 V LED 2x3W 3000 K 350 lm Ra 80

**R13571** preto

**€ 150**

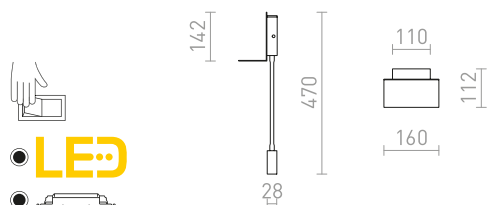



### ARAQ

Luminária de parede com casquilho e braço em latão sobre base lacada a preto. Para uso com uma fonte de luz decorativa E27 adequada.

#### ARAQ NA PAREDE

230 V E27 42 W

R13890 latão escovado/preto

€ 32

NEW

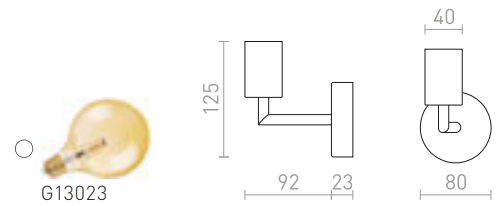

### HAREN

Refletor maciço equipado com casquilho E27 para uso com fonte de luz de foco.

#### HAREN DE SUPERFÍCIE

230 V E27 15 W

R13612 cobre/preto

€ 58

R13613 preto

€ 48

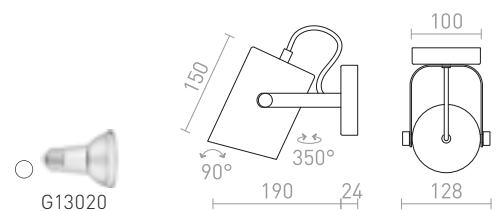



## VIPER

Luminária de parede com design elegante, detalhes cromados, um foco LED preto e um cabo têxtil vermelho.

### VIPER WL

230 V LED 3 W  $\angle 60^\circ$  3000 K 100 lm Ra 80

R12461 preto/cromo

€ 88 %

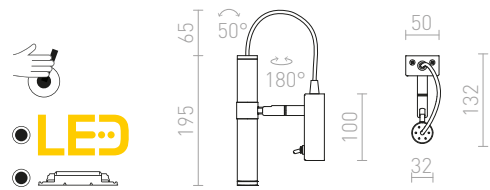

## FADO

Luminária de parede retangular com um foco LED ajustável.

### FADO I NA PAREDE

230 V LED 3 W  $\angle 45^\circ$  4000 K 110 lm Ra 80

R12473 preto

€ 129

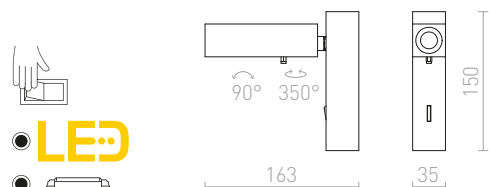

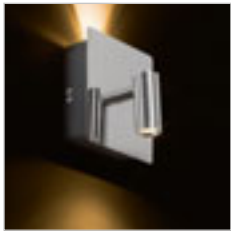

## TIARA

Luminária de parede LED com refletor e iluminação indireta superior. Possui duas fontes de luz que podem ser controladas separadamente por interruptores localizados na base da luminária.

### TIARA NA PAREDE

230 V LED 2x3 W  $\angle 25^\circ$  3000 K 300 lm Ra 80

R12957 cromo

€ 68

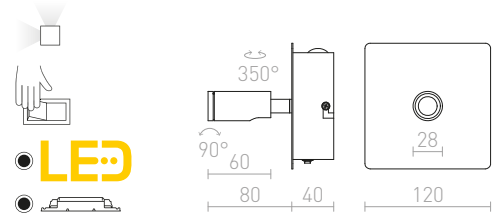

## TAPIO

Foco LED de parede embutido em base retangular

### TAPIO I SQ NA PAREDE

230 V LED 4,5 W 3000 K 350 lm Ra 80

R13423 preto

€ 88

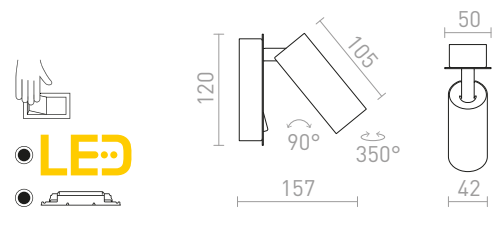

## MIG

Foco LED elegante de parede com interruptor adequado para uso no quarto. A base vem com uma entrada para cabos, para a opção de conectar a uma tomada próxima. Cabo não incluído.

### MIG NA PAREDE

230 V LED 3 W  $\angle 30^\circ$  3000 K 150 lm Ra 80

R13644 branco

€ 78

R13645 preto

€ 78

R13646 níquel mate

€ 68

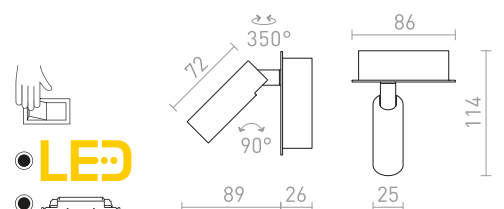





## AMADEUS

Aplique LED montado na parede com interruptor na base. O abajur é inclinável.

### AMADEUS I NA PAREDE

230 V LED 6 W 3000 K 530 lm Ra 80

R12476 branco

€ 120

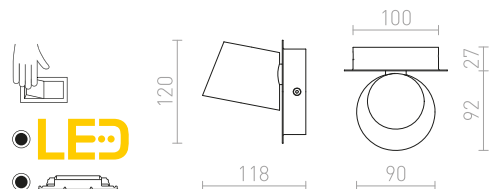



## THALIA

Luminária de parede LED com refletor complementada por iluminação indireta. A luminária possui duas fontes de luz que podem ser controladas separadamente por interruptores localizados na base da luminária.

### THALIA NA PAREDE

230 V LED 6 W + 3 W 3000 K 480 lm Ra 80

R13765 preto/acrílico acetinado

€ 138 **NEW**

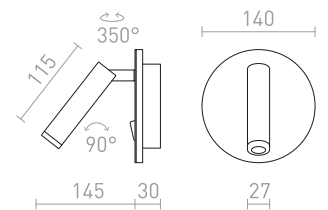

## STIG

Luz LED elegante com interruptor.

### STIG NA PAREDE

230 V LED 5,6 W  $\angle 34^\circ$  3000 K 404 lm Ra 80

R13941 preto

€ 98 **NEW**

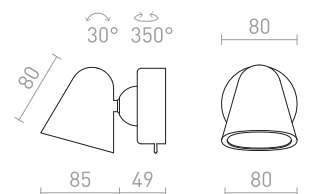



## VOLTERA

Luminária de parede pintada com reflector basculante para fontes luminosas com casquilho GU10.

A luminária possui uma porta USB integrada na base adequada para carregar, por exemplo, um telefone.

### VOLTERA USB NA PAREDE

230 V GU10 50 W

R13763 branco

€ 129 NEW

R13764 preto

€ 129 NEW

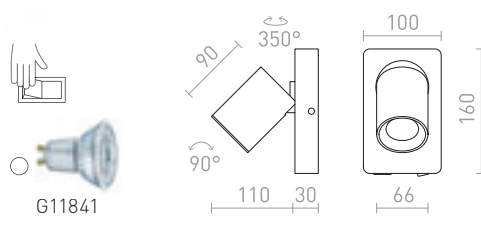

## ELISEO

Luminária de parede com cabeça giratória em forma de pires, LED embutido e difusor de cor opala.

### ELISEO NA PAREDE

230 V LED 5 W 3000 K 320 lm Ra 80

R13914 branco

€ 88 NEW

R13915 preto

€ 88 NEW

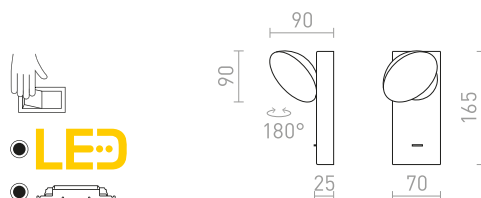



## SIENA

Luminária de parede pintada com reflector basculante para fontes luminosas com casquilho GU10. O interruptor está localizado na base.

### SIENA NA PAREDE

230 V GU10 50 W

**R13761** branco

€ 88 NEW

**R13762** preto

€ 88 NEW

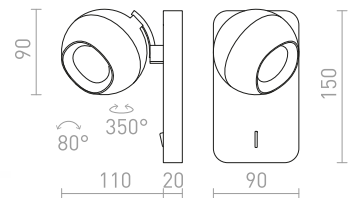



## BOGARD

Foco de parede inclinável com LED integrado.

### BOGARD I NA PAREDE

230 V LED 5W  $\angle 40^\circ$  3000 K 496 lm Ra 80

R12502 níquel mate

€ 58 %

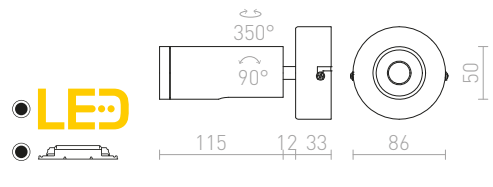

### BOGARD II NA PAREDE

230 V LED 2x5 W  $\angle 40^\circ$  3000 K 700 lm Ra 80

R12503 mate preto

€ 98 %

R12504 níquel mate

€ 48 %

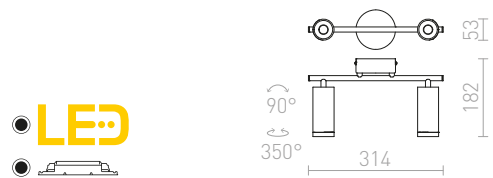

### BOGARD III NA PAREDE

230 V LED 3x5 W  $\angle 40^\circ$  3000 K 1050 lm Ra 80

R12505 mate preto

€ 120 %

R12506 níquel mate

€ 68 %

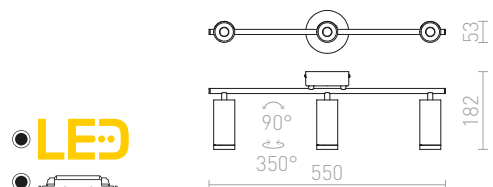





## KENNY

Série elegante de focos para fontes de luz GU10.  
É possível alterar a aparência com molduras de cores intercambiáveis (opcional).

### KENNY I DE SUPERFÍCIE

230 V GU10 35 W

**R12912** branco/preto € 58

**R12913** alumínio escovado/preto € 58

**R12914** preto/ouro € 58

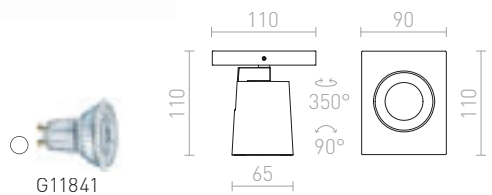

### KENNY II DE SUPERFÍCIE

230 V GU10 2x35 W

**R12915** branco/preto € 120

**R12916** alumínio escovado/preto € 120

**R12917** preto/ouro € 120

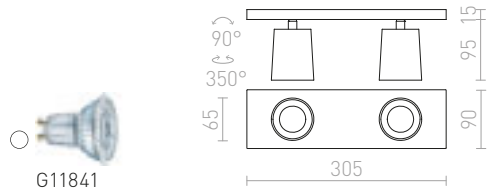

### KENNY III DE SUPERFÍCIE

230 V GU10 3x35 W

**R12918** branco/preto € 158

**R12919** alumínio escovado/preto € 150

**R12920** preto/ouro € 158

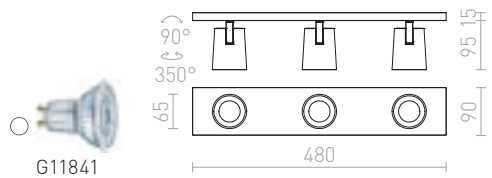

### KENNY IV TETO

230 V GU10 4x35 W

**R12921** branco/preto € 188

**R12922** alumínio escovado/preto € 178

**R12923** preto/ouro € 188

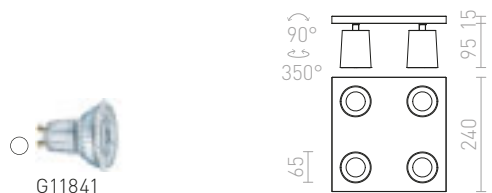



## KENNY

Anel de substituição da série Kenny, para facilmente alterar design através da cor.

### KENNY ANEL DECORATIVO

R12924 branco	€ 3.60
R12925 ouro	€ 3.60
R12926 preto	€ 3.60

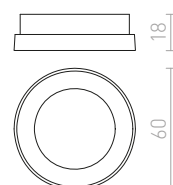





## DUDE

Lâmpada saliente para fontes de luz LED com casquilho GU10.

### DUDE SQ MONTADO À SUPERFÍCIE

230 V LED GU10 9 W

R13920 branco

€ 48 NEW

R13921 preto

€ 48 NEW

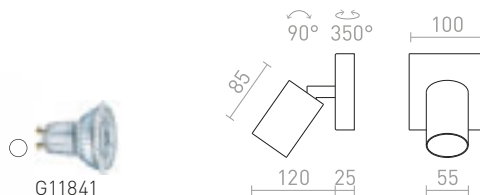

## DUDE

Lâmpada saliente para fontes de luz LED com casquilho GU10.

### DUDE R MONTADO À SUPERFÍCIE

230 V LED GU10 9 W

R13918 branco

€ 48 NEW

R13919 preto

€ 48 NEW

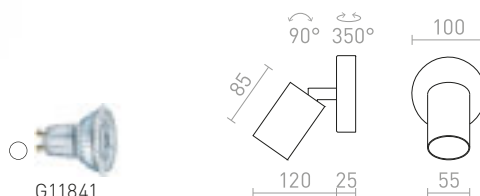

## DUDE

Projetor de montagem saliente para duas fontes de luz LED GU10.

### DUDE II MONTADO À SUPERFÍCIE

230 V LED GU10 2x9 W

R13922 branco

€ 98 NEW

R13923 preto

€ 98 NEW

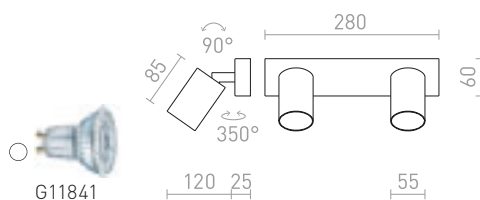



## DUDE

Luminária de parede com interruptor para fontes de luz LED com casquilho GU10.

**DUDE NA PAREDE**  
230 V LED GU10 9 W

**R13924** branco

€ 58 NEW

**R13925** preto

€ 58 NEW



G11841

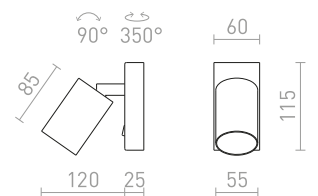





## DUGME

Foco de metal lacado em branco com detalhes de antracite.

### DUGME I

230 V GU10 35 W

R12076 branco/cinza antracite

€ 58

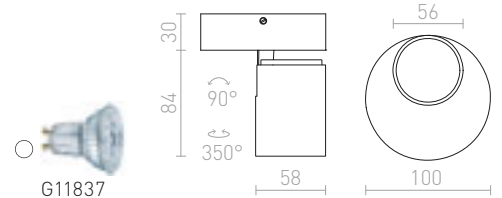

### DUGME II

230 V GU10 2x35 W

R12077 branco/cinza antracite

€ 120

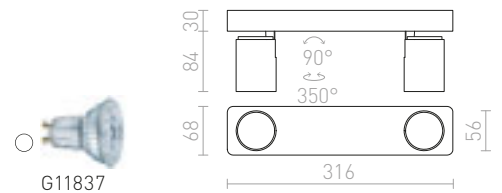

### DUGME III

230 V GU10 3x35 W

R12078 branco/cinza antracite

€ 129

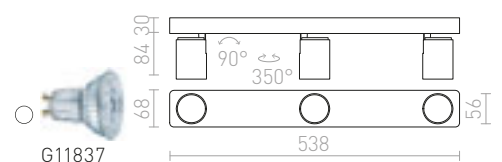



## TRICA

Foco de metal minimalista para instalação em parede ou teto, adequado para fontes de luz decorativas GU10.

### TRICA I NA PAREDE

230 V GU10 25 W

**R13371** branco

€ 22

%

**R13372** preto

€ 22

%



G11841

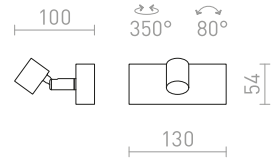

### TRICA II NA PAREDE

230 V GU10 2x25 W

**R13373** branco

€ 38

%

**R13374** preto

€ 38

%



G11841

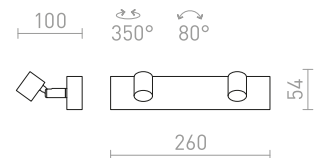

### TRICA III NA PAREDE

230 V GU10 3x25 W

**R13375** branco

€ 48

%

**R13376** preto

€ 48

%



G11841

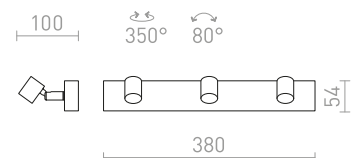





## KELLY LED

Luminária de parede ou teto com foco(s) inclinável. Módulos de LED incluídos.

### KELLY LED I NA PAREDE

230 V LED 12 W  $\angle 24^\circ$  3000 K 600 lm Ra 80

R12332 branco

€ 120 →

R12333 preto

€ 120 →

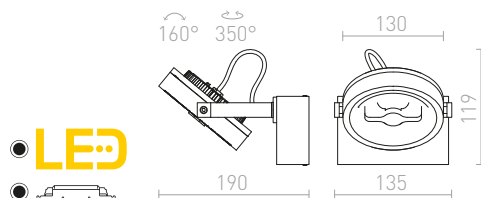

### KELLY LED II NA PAREDE

230 V LED 2x12 W  $\angle 24^\circ$  3000 K 1200 lm Ra 80

R12334 branco

€ 198 →

R12335 preto

€ 198 →

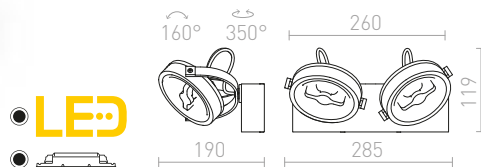

### KELLY LED III NA PAREDE

230 V LED 3x12 W  $\angle 24^\circ$  3000 K 1800 lm Ra 80

R12336 branco

€ 290 →

R12337 preto

€ 290 →

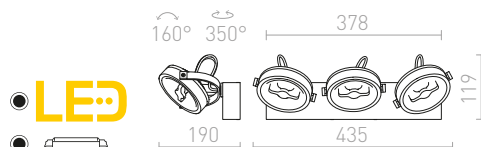



## KELLY LED

Luz regulável semi-embutida com LED integrado e um foco direcional. Somente para instalação em teto de gesso cartonado. Regulação da intensidade da luz TRIAC.

### KELLY LED DIMM SEMI EMBUTIDA

230 V LED 12 W  $\angle 24^\circ$  3000 K 600 lm Ra 80

**R12637** branco

€ 98

**R12638** preto

€ 98

↑ 50

● Ø65

● LED

● regulável

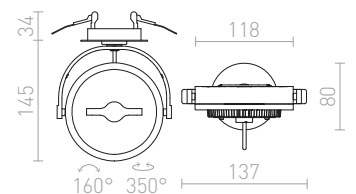







## KELLY LED

Luminária de parede/teto com foco(s) e regulação de intensidade da luz TRIAC. Módulos de LED incluídos.

### KELLY LED I DIMM NA PAREDE

230 V LED 12 W  $\angle 24^\circ$  3000 K 600 lm Ra 90

R13104 branco

€ 129

R13105 preto

€ 129

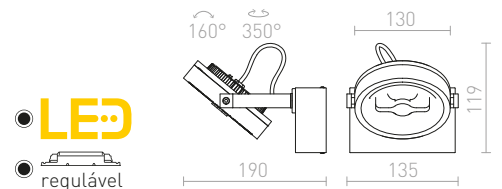

### KELLY LED II DIMM NA PAREDE

230 V LED 2x12 W  $\angle 24^\circ$  3000 K 1200 lm Ra 90

R13106 branco

€ 238

R13107 preto

€ 238

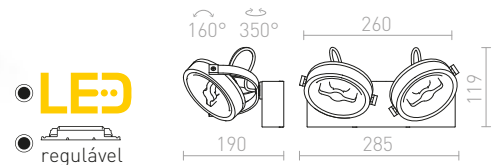

### KELLY LED III DIMM NA PAREDE

230 V LED 3x12 W  $\angle 24^\circ$  3000 K 1800 lm Ra 80

R13108 branco

€ 360

R13109 preto

€ 360

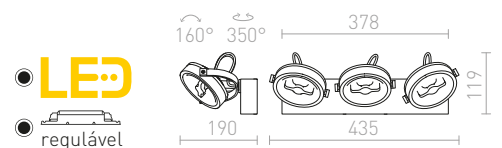





## ELISEO

Lâmpada LED montada em superfície com cabeça giratória em forma de pires e difusor de cor opala.

**ELISEO II MONTADO À SUPERFÍCIE**  
230 V LED 2x5 W 3000 K 760 lm Ra 80

**R13916** branco

€ 138

NEW

**R13917** preto

€ 138

NEW

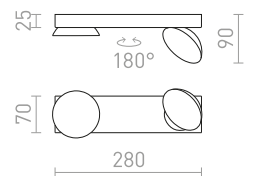

## ELISEO

Luminária de parede com cabeça giratória em forma de pires, LED embutido e difusor de cor opala.

**ELISEO NA PAREDE**  
230 V LED 5 W 3000 K 320 lm Ra 80

**R13914** branco

€ 88

NEW

**R13915** preto

€ 88

NEW

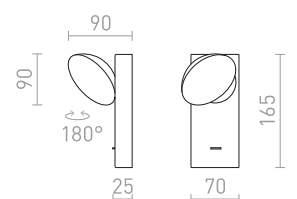



## GLOSSY

Luminária saliente com focos inclináveis em dois eixos.

### GLOSSY I

230 V LED GU10 8 W

R10542 cromo

€ 48 %

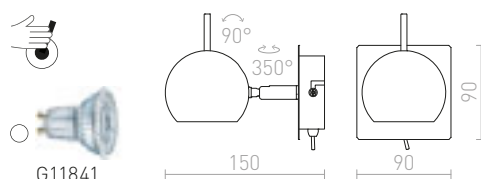

### GLOSSY III

230 V LED GU10 3x8 W

R10604 cromo

€ 78 %

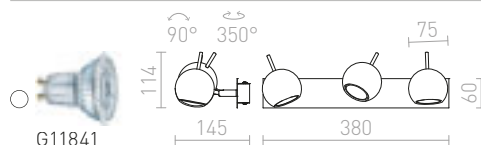

## GLOSSY

Luminária de parede com foco em braço articulado. A luminária funciona com um interruptor de alavanca localizado na parte inferior.

### GLOSSY EM BRAÇO ARTICULADO

230 V LED GU10 8 W

R10543 cromo

€ 58 %

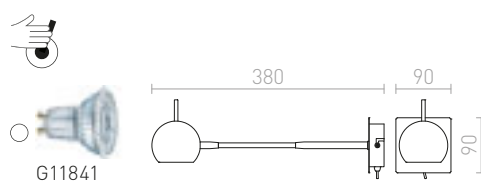



## ROSITA

Aplique de estilo retro para fontes de luz GU10 com baixo consumo energético.

### ROSITA I NA PAREDE

230 V LED GU10 9 W

**R12507** branco/cinza prata

€ 58

**R12508** preto/ouro

€ 58

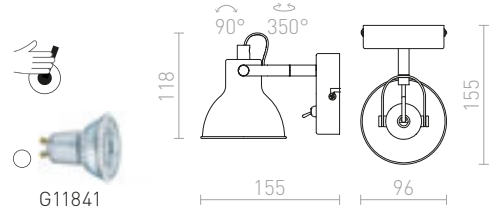

### ROSITA II NA PAREDE

230 V LED GU10 2x9 W

**R12509** branco/cinza prata

€ 88

**R12510** preto/ouro

€ 120

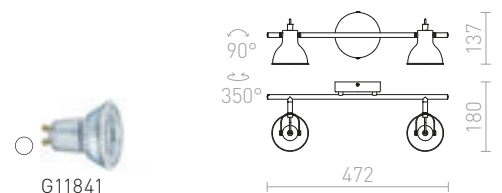



## EKE

Luminária de parede com foco LED em braço articulado e interruptor na base.

### EKE NA PAREDE

230 V LED 3W  $\angle 60^\circ$  3000 K 100 lm Ra 80

R12944 branco

€ 58

R12945 preto

€ 58

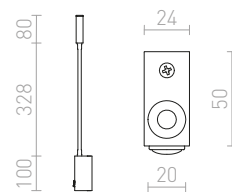

## FRISCO

Luminária de parede LED em braço flexível com interruptor na base. O foco retangular fornece uma ampla dispersão de luz.

### FRISCO W NA PAREDE

230 V LED 4,2W  $\angle 120^\circ$  3000 K 300 lm Ra 80

R12942 preto

€ 98 %

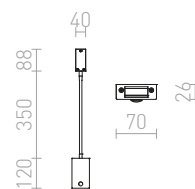

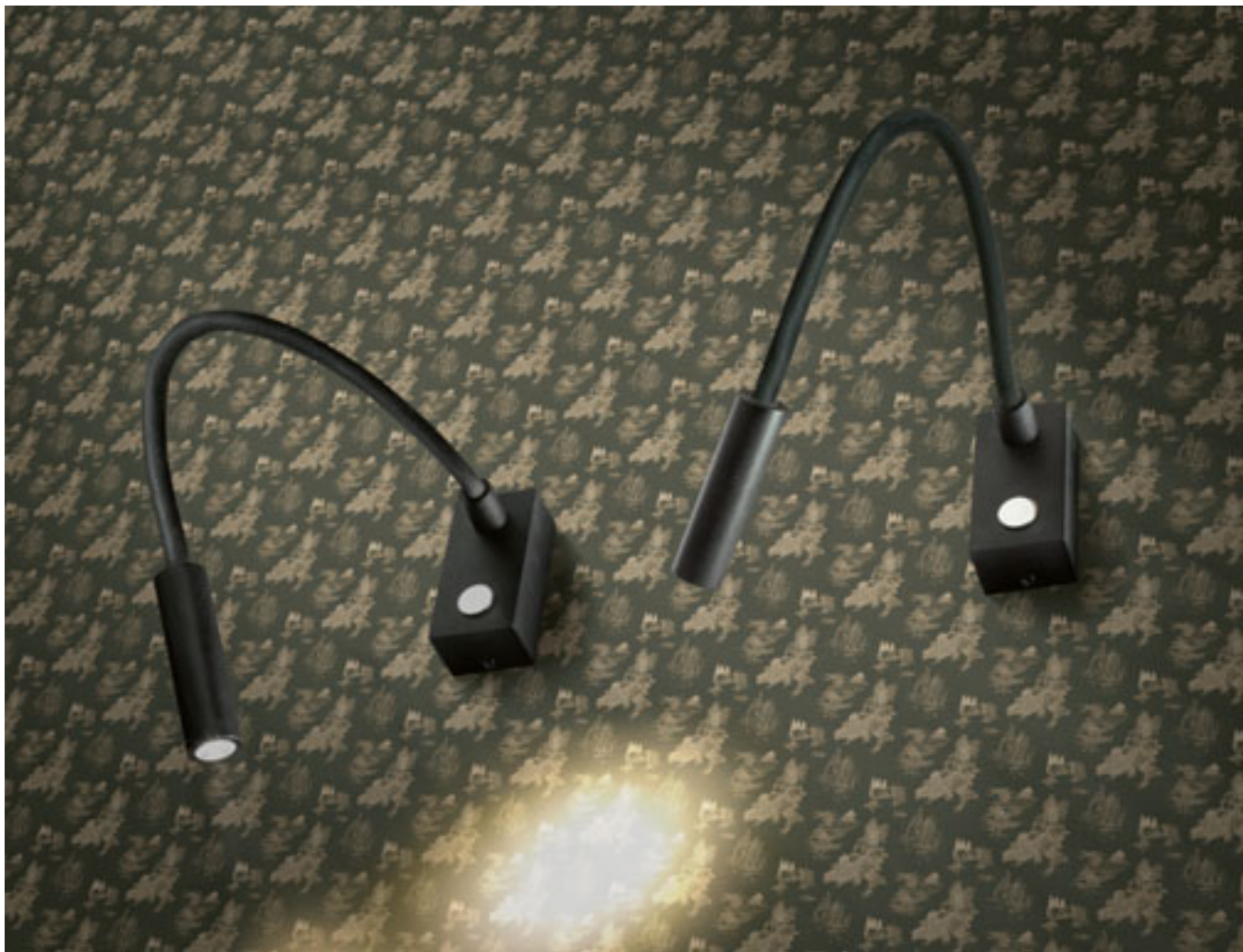

### AIM

Luminária de parede LED com braço flexível. O interruptor de toque está localizado na base da luminária.

#### AIM COM BRAÇO ARTICULADO

230 V LED 3 W  $\angle 45^\circ$  3000 K 180 lm Ra 80

R10541 preto

€ 150

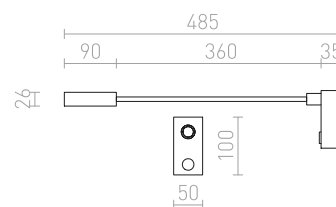





## POINT

Foco LED com braço articulado. O botão de alavanca está localizado na parte inferior da base.

### POINT NA PAREDE

230 V LED 3 W  $\angle 40^\circ$  3000 K 240 lm Ra 80

R11758 níquel mate

€ 68 %

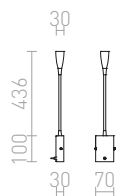



## VERSA

Foco LED com braço articulado. O botão de alavanca está localizado na parte inferior da base.

### VERSA NA PAREDE

230 V LED 3 W  $\angle 40^\circ$  3000 K 240 lm Ra 80

R10602 níquel mate

€ 88

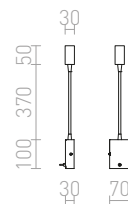

## SHOW

Foco LED em braço articulado para montagem em parede.

### SHOW NA PAREDE

230 V LED 3 W 3000 K 240 lm Ra 80

R12896 branco/cromo

€ 78

R12897 preto/cromo

€ 78

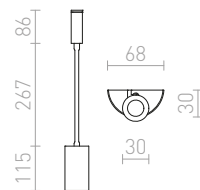

## BOB

Foco com LED integrado com braço articulado. O interruptor de alavanca está localizado na base.

### BOB COM BRAÇO ARTICULADO

230 V/500 mA LED 3 W  $\angle 45^\circ$  3000 K 180 lm Ra 80

R10538 cromo

€ 120





## KAYA

Luminária de parede com abajur metálico em braço articulado e interruptor na base, para fontes de luz E27.

### KAYA NA PAREDE

230 V E27 28 W

R12898 branco/níquel mate

€ 48



G13026

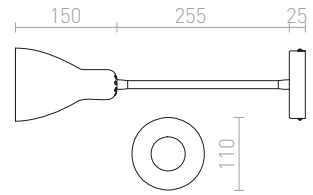

## FLAP

Luminária pequena de parede com LED em braço articulado, um foco circular e interruptor na base.

### FLAP NA PAREDE

230 V LED 4,2W  $\angle 120^\circ$  3000 K 100lm Ra 80

R12943 cromo

€ 68

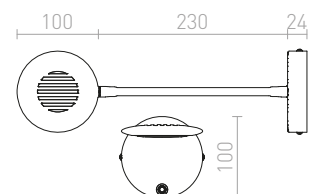



## VALE

Lâmpada LED de parede com braço articulado com interruptor na base. Uma entrada para cabos pode ser encontrada na base, para a opção de conectar a tomadas próximas. Cabo não incluído.

### VALE NA PAREDE

230 V LED 3 W  $\angle 30^\circ$  3000 K 150 lm Ra 80

**R13647** branco

€ 98

**R13648** preto

€ 98



LED 28°



65 490 105

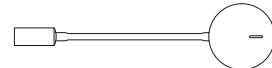

27 27

660



## CELEIA

Foco de metal cilíndrico para uso com fonte de luz E27 adequada.

### CELEIA MONTADO À SUPERFÍCIE

230 V E27 40 W

**R13901** mate branco/níquel mate

€ 48

NEW

**R13902** mate preto/cobre escovado

€ 48

NEW

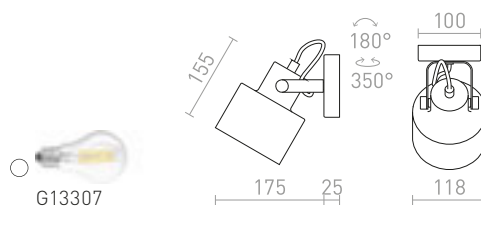

## BAROQUE

Luminária de parede pequena para fontes de luz com casquilho E27, com um foco amplo e interruptor na base.

### BAROQUE NA PAREDE

230 V E27 28 W

**R12986** preto/cromo

€ 58

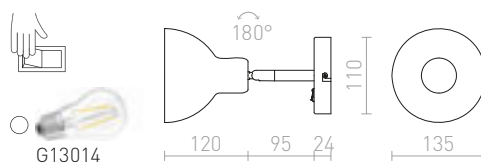



## AGNETA

Cortina de metal giratória redonda com base, para uso com uma fonte de luz E27 adequada.

### AGNETA MONTADO À SUPERFÍCIE

230 V E27 40 W

**R13893** branco

€ 48 NEW

**R13894** preto

€ 48 NEW

**R13895** latão escovado/preto

€ 78 NEW

**R13896** cobre escovado/preto

€ 78 NEW

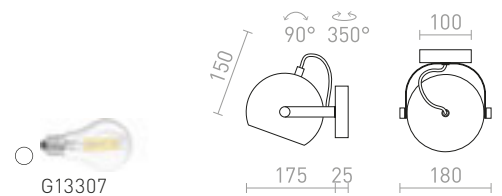

G13307



## JOLI

Foco inclinável em plástico para fontes de luz LED com casquilho GU10.

### JOLI I NA PAREDE

230 V LED GU10 10 W

**R13556** preto

€ 38

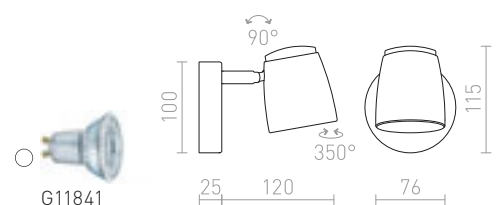

G11841



## BELENOS

Foco cilíndrico minimalista para fontes de luz GU10 sobre base redonda. As molas ligadas ao casquilho permitem o uso de fontes de luz de vários comprimentos.

### BELENOS TETO

230 V LED GU10 9 W

R13363 branco

€ 48

R13364 preto

€ 48

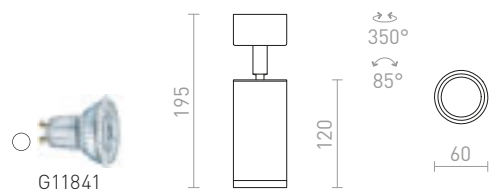



## OPTIMUS

Foco de teto cilíndrico com possibilidade de ajuste do cone de luz mediante sistema de zoom de 10-50°. O foco é adequado para fontes de luz LED com um casquilho GU10. Use fontes de luz com um ângulo de feixe de 120° na luminária para evitar sombras indesejadas.

### OPTIMUS TETO

230 V LED GU10 9 W  $\angle$ 10-50°

R13779 branco

€ 58

R13780 preto

€ 58

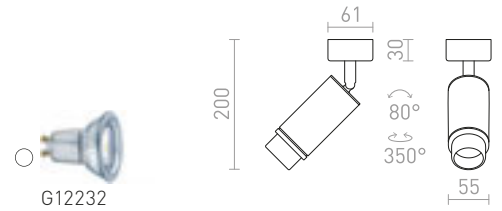

## BOGARD

Foco direcional tubular LED de teto ajustável.

### BOGARD TETO

230 V LED 5 W  $\angle$ 40° 3000 K 414 lm Ra 80

R12497 mate preto

€ 68

R12498 níquel mate

€ 78

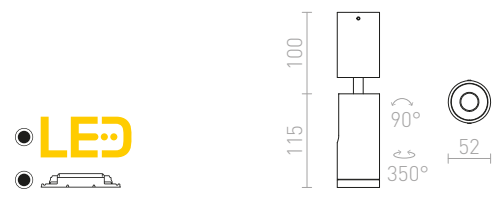

## BOGARD

Luminária de teto LED com um foco fixo e um ajustável.

### BOGARD TWIN TETO

230 V LED 2x5 W  $\angle$ 40° 3000 K 700 lm Ra 80

R12499 mate preto

€ 120

R12500 níquel mate

€ 88

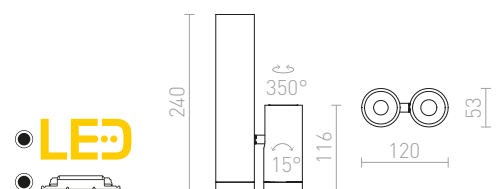





## DARIO

Luminária cilíndrica direcional com casquilho GU10 para fontes de luz LED, que inclui um tom decorativo de latão preto escovado. Diferentes combinações de cores estão disponíveis comprando tons adicionais em outras cores.

### DARIO TETO

230 V GU10 9 W

**R13867** branco/latão escovado

€ 68

NEW

**R13868** preto/latão escovado

€ 68

NEW

**R13869** latão escovado

€ 78

NEW



G11841

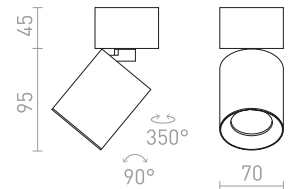

## DARIO

Tonalidade decorativa interna de metal em várias cores para a luz DARIO.

### DARIO ANEL DECORATIVO

**R13876** branco

€ 8.50

NEW

**R13877** preto

€ 8.50

NEW

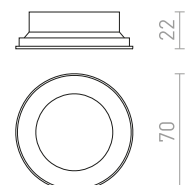
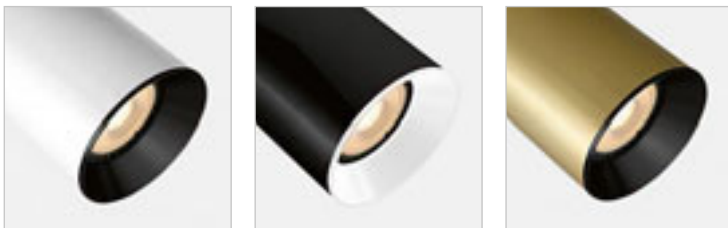

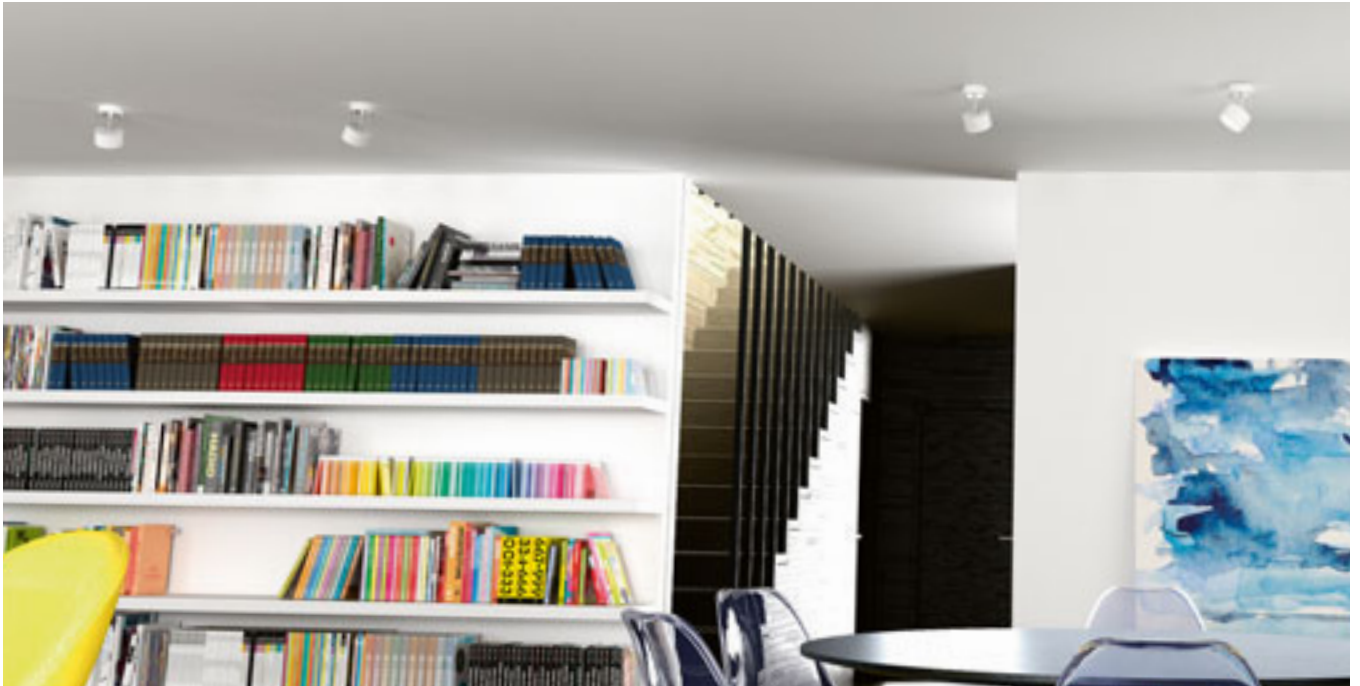

## PIXIE

Luminária inclinada na base para fontes de luz LED GX53 de baixo consumo energético.

### PIXIE DIRECIONAL

230 V LED GX53 7 W

**R11772** branco/cromo

€ 138

**R11773** preto/cromo

€ 138

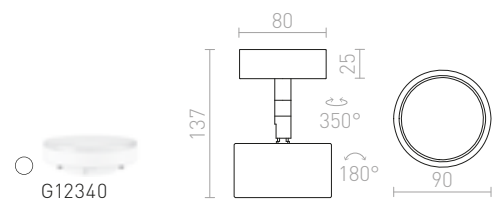

IP44



## ORIT

Foco inclinável em alumínio para exterior equipado com LED de 6W. Luz inclinável em apenas um eixo.

### ORIT NA PAREDE

230 V LED 6 W  $\angle 80^\circ$  3000 K 315 lm Ra 80 IP44

**R12033** alumínio

€ 78

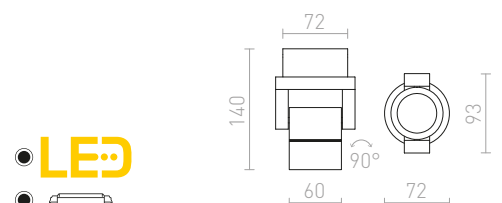



## REDO

Foco direcional de alumínio maciço.

### REDO DIRECIONAL

230 V GU10 50 W

R10173 alumínio

€ 35 →

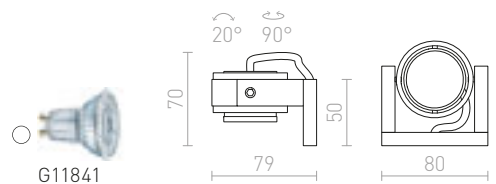



## MARVEL

Luminária angular de alumínio para duas fontes de luz GU10 que podem ser inclinadas individualmente em base central.

### MARVEL II DIRECIONAL

230 V GU10 2x50 W

R10171 alumínio

€ 48 %

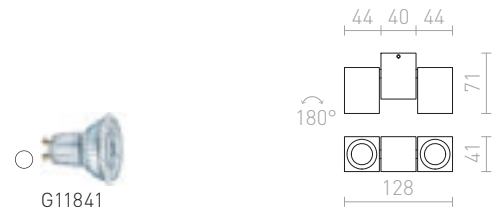

## CASSIE

Luminária de parede/teto com foco inclinável.

### CASSIE NA PAREDE

230 V/12 V G53 50 W

R10591 níquel mate

€ 58 %

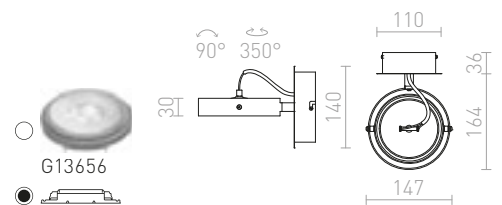

## BUGSY

Luminária de parede com abajur de vidro espelhado e base cromada.

### BUGSY I NA PAREDE

230 V GU10 50 W

R10521 vidro cromado

€ 48 %

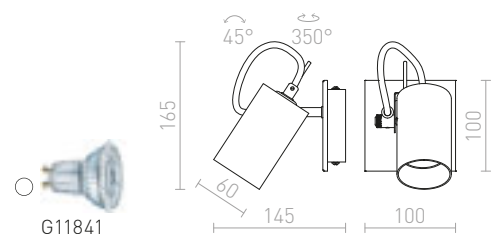



## CANDEEIROS DE MESA

DECORATIVO 322-339

ESCRITÓRIO 340-347

# CANDEEIROS DE MESA DECORATIVO

322-339



**AMBITUS/ALVIS 24**  
322-323



**ALVIS/AMBITUS 30**  
322-323



**EL PASO**  
324-325



**GARDETTE**  
324-325



**ALVIS/RON 40**  
324-325



**KEITH/ALVIS 24**  
326-327



**KEITH/DELISA**  
326-327



**MAUI/ALVIS 24**  
326-327



**BROADWAY**  
326-327



**KEITH/AMBITUS 30**  
328-329



**MAUI/AMBITUS 30**  
328-329



**PERTH**  
328-329



**ESPLANADE**  
330-331



**EDIKA**  
330-331



**LAURA**  
330-331



**LULU**  
332-333



**MAUI/CONNY 15/30**  
332-333



**NYC/CONNY 15/15**  
332-333



**NYC/CONNY 15/30**  
332-333



**KEITH/RON 15/20**  
334-335



**NYC/RON 15/20**  
334-335



**ZUMBA**  
334-335



**NYC/TEMPO 15/30**  
336-337



**MONACO**  
336-337



**PLAZA S**  
336-337



**PLAZA M**  
336-337



**CAMINO**  
338-339



**CAMINO**  
338-339



**HEIDI**  
338-339



**ALGOT**  
338-339

## CANDEEIROS DE MESA ESCRITÓRIO

340-347



**MONTANA**  
340-341



**RITZY**  
340-341



**NIZZA**  
340-341



**GARBO**  
342-343



**ANIKA**  
342-343



**CELEIA**  
342-343



**BUGSY**  
344-345



**JOLI**  
344-345



**ROSITA**  
344-345



**FRISCO T**  
344-345



**FADO**  
346-347



**VIPER TL**  
346-347



**COZY**  
346-347



**TAPIO**  
346-347







### AMBITUS/ALVIS

Um candeeiro de mesa com um abajur em tecido e uma elegante base em bambu. Adequado para fontes de luz LED E27.

#### AMBITUS/ALVIS 24 DE MESA

230 V LED E27 7 W

R14040 branco creme/bambu

€ 150 **NEW**



G13015

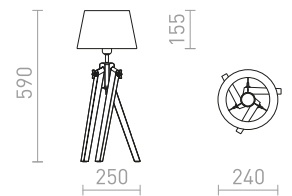

### ALVIS/AMBITUS

Um candeeiro de mesa com um abajur em tecido e uma elegante base em bambu. Adequado para fontes de luz LED E27.

#### ALVIS/AMBITUS 30 DE MESA

230 V LED E27 11 W

R14041 Poli-algodão branco/bambu

€ 178 **NEW**



G13026

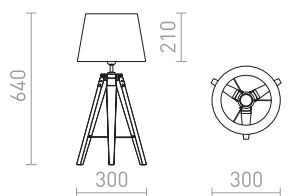



## ALVIS/RON

Um candeeiro de mesa com um abajur em tecido e uma elegante base em bambu. Adequado para fontes de luz LED E27.

### ALVIS/RON 40 DE MESA

230 V LED E27 11 W

R14042 Poli-algodão branco/bambu

€ 188 **NEW**

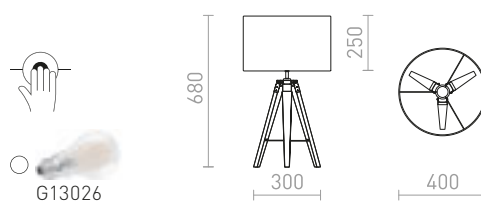

## GARDETTE

Candeeiro de mesa para tripés com ajuste de altura e abajur têxtil e casquilhos E27.

### GARDETTE DE MESA

230 V E27 42 W

R12488 preto/alumínio

€ 150 **%**

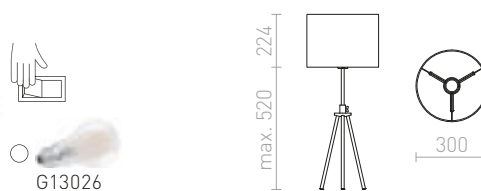



### EL PASO

Candeeiro de mesa de bambu com um abajur têxtil.  
Este artigo é entregue desmontado.

#### EL PASO DE MESA

230 V E14 11 W

R13338 cinzento/bambu

€ 68 %



G12243

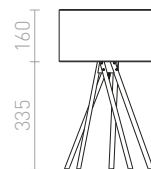



## KEITH/ALVIS

Um candeeiro de mesa com um abajur em tecido e uma base com uma porta USB integrada. A base é em imitação de faia com pormenores lacados a branco. Adequado para fontes de luz LED E27.

### KEITH/ALVIS 24 DE MESA COM USB

230 V LED E27 7 W

R14038 branco creme/faia

€ 138 **NEW**



G13015

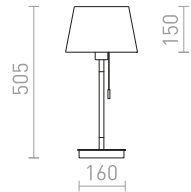

240



## KEITH/DELISA

Um candeeiro de mesa com um abajur decorativo adornado com botões coloridos. A base em imitação de faia com pormenores lacados a branco inclui uma porta USB. Adequado para fontes de luz LED E27.

### KEITH/DELISA DE MESA COM USB

230 V LED E27 7 W

R14037 branco/botões/faia

€ 129 **NEW**



G13015

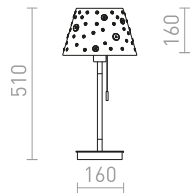

250



### MAUI/ALVIS

Um candeeiro de mesa com uma base em madeira e um abajur em tecido. Adequado para fontes de luz LED E27.

#### MAUI/ALVIS 24 DE MESA

230 V LED E27 7 W

R14033 branco creme/madeira

€ 98 **NEW**



G13015

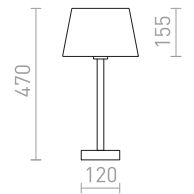

240



### BROADWAY

Candeeiro de mesa com um abajur têxtil texturado branco e base cromada.

#### BROADWAY DE MESA

230 V E27 42 W

R11986 branco/cromo

€ 178 **➔**



G13026

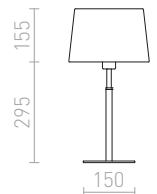

234



## KEITH/AMBITUS

Um candeeiro de mesa com um abajur em tecido e uma porta USB integrada na base. A base é em imitação de faia com pormenores lacados a branco. Adequado para fontes de luz LED E27.

### KEITH/AMBITUS 30 DE MESA COM USB

230 V LED E27 11 W

R14039 Poli-algodão branco/faia

€ 178 **NEW**



G13026

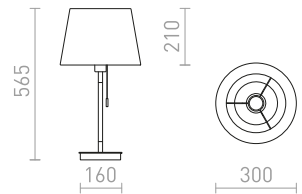

## MAUI/AMBITUS

Um candeeiro de mesa com uma base em madeira e um abajur em tecido. Adequado para fontes de luz LED E27.

### MAUI/AMBITUS 30 DE MESA

230 V LED E27 11 W

R14035 Poli-algodão branco/madeira

€ 120 **NEW**



G13026

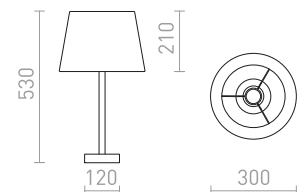

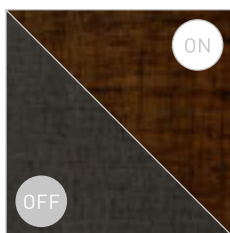
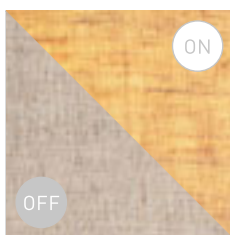

## PERTH

Candeeiro de mesa com abajur quadrado em tecido e base metálica.

### PERTH DE MESA

230 V E27 15 W

**R13663** bege/branco

€ 150

**R13664** preto/preto

€ 150



G13307

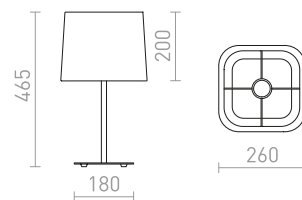





## EDIKA

Candeeiro de mesa em níquel com perna telescópica e abajur têxtil com casquilho E27.

### EDIKA DE MESA

230 V E27 42 W

R12665 castanho/níquel mate

€ 138 →



G13026

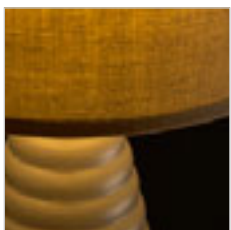
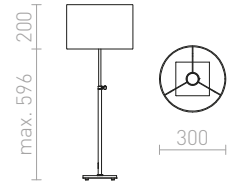

## LAURA

Candeeiro de mesa decorativo com um abajur têxtil.

### LAURA DE MESA

230 V E27 28 W

R13324 cinzento bege

€ 48 →

R13325 preto

€ 58 →



G13026

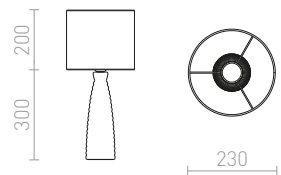



## ESPLANADE

Candeeiro de mesa com abajures têxteis duplos e altura regulável.

### ESPLANADE DE MESA

230 V E27 42 W

R12484 preto transparente/branco/cromo

€ 268



G13026

max. 525  
218

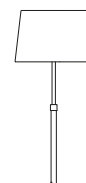

327





## NYC/CONNY

Um candeeiro de mesa com um abajur em tecido numa base metálica. Adequado para fontes de luz LED E27.

### NYC/CONNY 15/15 DE MESA

230 V LED E27 7 W

	<b>R14047</b> Poli-algodão branco/cromo	€ 120	NEW
	<b>R14048</b> Poli-algodão branco/níquel	€ 120	NEW

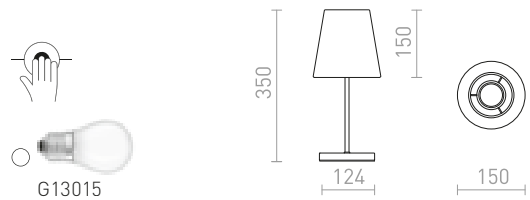

### NYC/CONNY 15/30 DE MESA

230 V LED E27 7 W

	<b>R14049</b> Poli-algodão branco/cromo	€ 120	NEW
	<b>R14050</b> Poli-algodão branco/níquel	€ 120	NEW
	<b>R14051</b> monaco pomba gris/prata PVC/cromo	€ 150	NEW
	<b>R14052</b> monaco pomba gris/prata PVC/níquel	€ 150	NEW
	<b>R14053</b> monaco gasolina azul/prata PVC/cromo	€ 150	NEW
	<b>R14054</b> monaco gasolina azul/prata PVC/níquel	€ 150	NEW

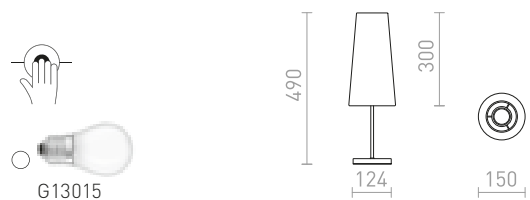



### MAUI/CONNY

Um candeeiro de mesa com uma base em madeira e um abajur em tecido. Adequado para fontes de luz LED E27.

#### MAUI/CONNY 15/30 DE MESA

230 V LED E27 7 W

R14034 Poli-algodão branco/madeira

€ 120

NEW



G13015

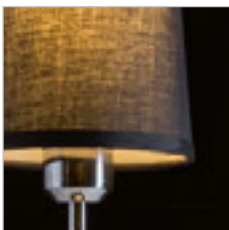
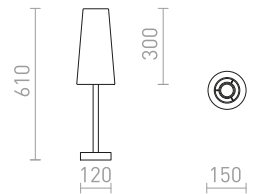

### LULU

Candeeiro de mesa com abajur cónico têxtil e casquilho E27. A base tem uma elegante combinação de cromo e preto.

#### LULU DE MESA

230 V E27 28 W

R12464 branco/preto/cromo

€ 129

R12465 preto/cromo

€ 129



G13026

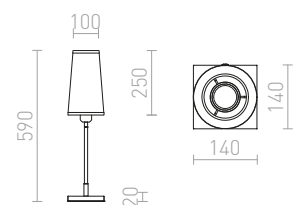











## NYC/RON

Um candeeiro de mesa com um abajur em tecido numa base metálica. Adequado para fontes de luz LED E27.

### NYC/RON 15/20 DE MESA

230 V LED E27 7 W

	<b>R14055</b> Poli-algodão branco/cromo	€ 120	NEW
	<b>R14056</b> Poli-algodão branco/níquel	€ 120	NEW
	<b>R14057</b> monaco pomba gris/prata PVC/cromo	€ 150	NEW
	<b>R14058</b> monaco pomba gris/prata PVC/níquel	€ 150	NEW
	<b>R14059</b> monaco gasolina azul/prata PVC/cromo	€ 150	NEW
	<b>R14060</b> monaco gasolina azul/prata PVC/níquel	€ 150	NEW
	<b>R14061</b> Poli-algodão preto/cromo	€ 120	NEW
	<b>R14062</b> Poli-algodão preto/níquel	€ 120	NEW

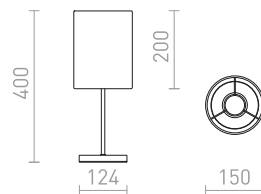



## KEITH/RON

Um candeeiro de mesa com um abajur em tecido e uma porta USB integrada na base. A base é em imitação de faia com pormenores lacados a branco. Adequado para fontes de luz LED E27.

### KEITH/RON 15/20 DE MESA COM USB

230 V LED E27 7 W

R14036 Poli-algodão branco/faia

€ 158

NEW



G13026

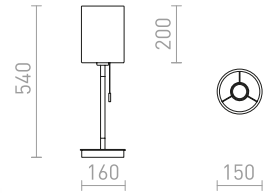

## ZUMBA

Candeeiro de mesa pequeno sobre uma base de madeira com um abajur de plástico. Este artigo é entregue desmontado.

### ZUMBA DE MESA

230 V E14 11 W

R13320 PVC branco/madeira/cromo

€ 48

%



G11849

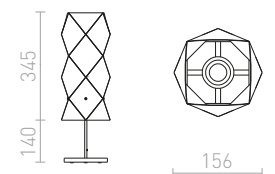



## MONACO

Candeeiro de mesa compacto com abajur têxtil preto sobre base cromada.

### MONACO DE MESA

230 V E27 28 W

R12040 preto/cromo

€ 32 →

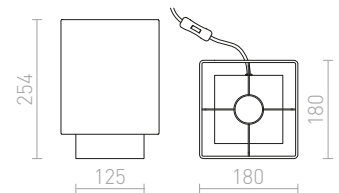
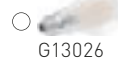



## PLAZA

Candeeiro de mesa com abajur têxtil texturado.

### PLAZA S DE MESA

230 V E27 42 W

R11973 branco/cromo

€ 158

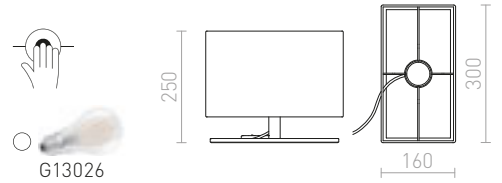

### PLAZA M DE MESA

230 V E27 42 W

R11983 branco/cromo

€ 215

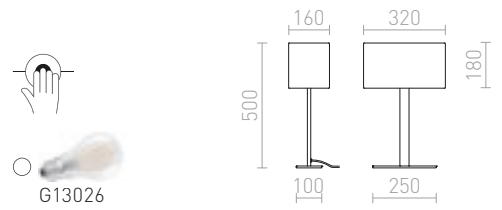

## NYC/TEMPO

Um candeeiro de mesa com um abajur em tecido numa base metálica. Adequado para fontes de luz LED E27.

### NYC/TEMPO 15/30 DE MESA

230 V LED E27 7 W

R14063 Polí-algodão branco/cromo

€ 129

NEW

R14064 Polí-algodão branco/níquel

€ 129

NEW

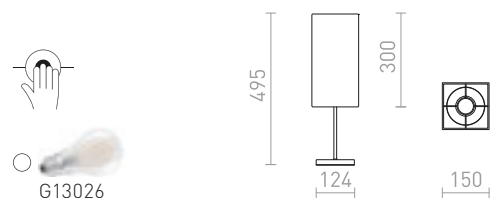





## ALGOT

Base de candeeiro de mesa para uso com uma fonte de luz decorativa E27 adequada.

### ALGOT DE MESA

230 V E27 40 W

R13907 preto/cobre escovado

€ 25 **NEW**



G13459

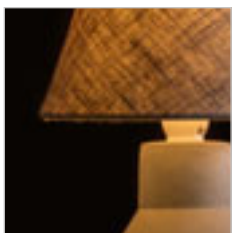
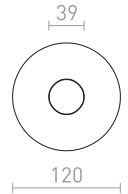
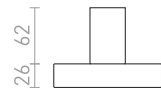

## HEIDI

Candeeiro de mesa decorativo de cimento com abajur têxtil para fontes de luz E14.

### HEIDI DE MESA

230 V E14 12 W

R12379 natural/cimento

€ 48



G12243

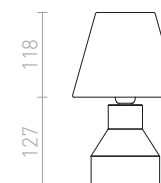



## CAMINO

Candeiro de mesa minimalista, de forma cilíndrica, que inclui um abajur têxtil. Cada base tem o seu acabamento exclusivo.

### CAMINO DE MESA COM ABAJUR

230 V E27 28 W

R13294 branco/terrazzo decor

€ 78

R13295 branco/cimento

€ 78



G13026

200  
135

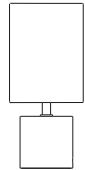

150



## CAMINO

Candeiro de mesa minimalista de forma cilíndrica, para fontes de luz decorativas adequadas. Cada base tem o seu acabamento exclusivo.

### CAMINO DE MESA

230 V E27 28 W

R13293 terrazzo decor

€ 48



G13311

110

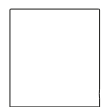

100



## RITZY

Candeeiro de mesa com ajuste para regular a altura, em preto e cromo. Vem com abajur têxtil e casquilho E27.

### RITZY DE MESA

230 V E27 42 W

R12486 preto/cromo

€ 178 %



max. 550  
150

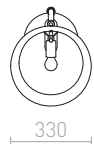
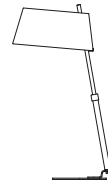

400

330



## NIZZA

Um candeeiro de mesa com um braço regulável em madeira, uma base em metal lacado e um abajur em tecido.

**NIZZA DE MESA**  
230 V LED E14 7 W

**R14031** Poli-algodão branco/madeira

€ 178 **NEW**

**R14032** Poli-algodão preto/madeira

€ 188 **NEW**

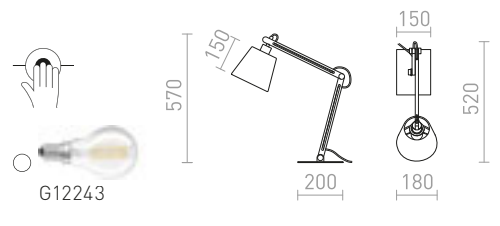

## MONTANA

Candeeiro de mesa com braço ajustável e abajur têxtil.

**MONTANA DE MESA**  
230 V E27 28 W

**R13283** branco/preto/cromo

€ 320 **➔**

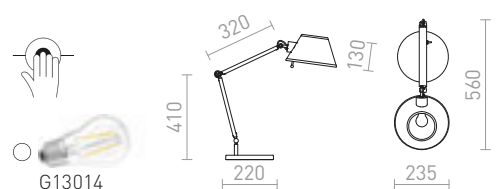



## ANIKA

Candeeiro de mesa de metal com braço ajustável para uso com uma fonte de luz E27 adequada.

### ANIKA DE MESA

230 V E27 40 W

**R13905** mate branco/níquel mate

€ 68

NEW

**R13906** mate preto/níquel mate

€ 68

NEW

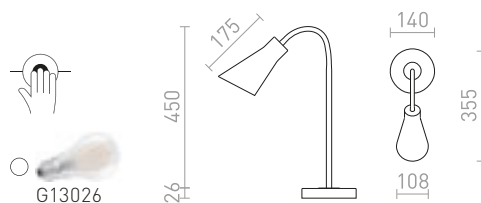

## CELEIA

Candeeiro de mesa cilíndrico de metal para uso com fonte de luz E27 adequada.

### CELEIA DE MESA

230 V E27 40 W

**R13903** mate branco/níquel mate

€ 98

NEW

**R13904** mate preto/cobre escovado

€ 98

NEW

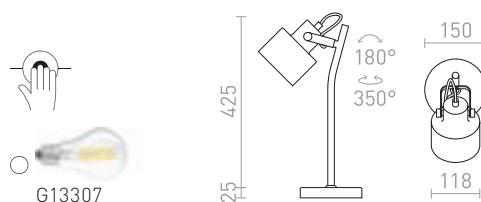



## GARBO

Candeeiro de mesa de metal com casquilho E27.

### GARBO DE MESA

230 V E27 28 W

R12675 preto/cromo

€ 58



G13026

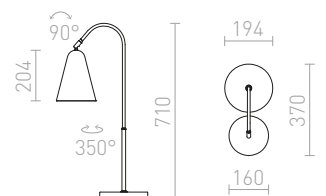



## BUGSY

Candeeiro de mesa com abajur de vidro espelhado, inclinável em um eixo.

### BUGSY DE MESA

230 V GU10 50 W

R10519 vidro cromado

€ 120 %



G11841

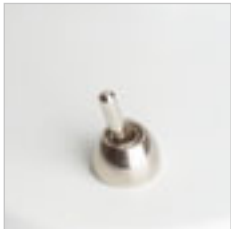
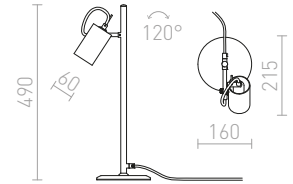

## ROSITA

Candeeiro de mesa de estilo retro para fontes de luz GU10 com baixo consumo de energia.

### ROSITA DE MESA

230 V LED GU10 9 W

R12512 preto/ouro

€ 120



G11841

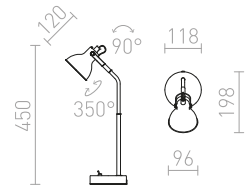

## FRISCO

Candeeiro de mesa LED em braço articulado com interruptor na base. O foco retangular fornece uma ampla dispersão de luz.

### FRISCO T DE MESA

230 V LED 4,2 W  $\angle 120^\circ$  3000 K 300 lm Ra 80

R12940 preto

€ 120 %

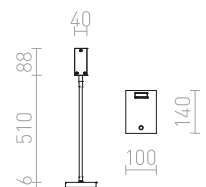



## JOLI

Candeeiro de mesa em plástico para fontes de luz LED com casquilho GU10.

**JOLI DE MESA**  
230 V LED GU10 10 W

**R13558** preto

**€ 58**



G11841

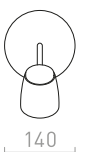
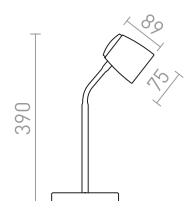





## TAPIO

Candeeiro de mesa LED com foco cilíndrico direcional.

### TAPIO DE MESA

230 V LED 4,5 W 3000 K 350 lm Ra 80

R13429 preto

€ 98

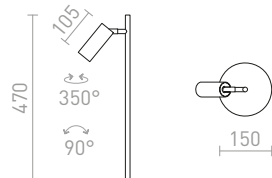
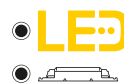



## FADO

Candeeiro de mesa em design angular com um foco LED ajustável.

### FADO DE MESA

230 V LED 3 W  $\angle 45^\circ$  3000 K 110 lm Ra 80

R12474 preto

€ 120

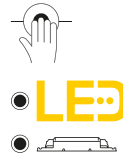
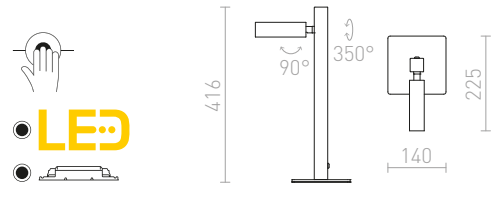

## VIPER

Candeeiro de mesa com design elegante, um foco LED ajustável preto, cabo têxtil vermelho e detalhes cromados.

### VIPER TL DE MESA

230 V LED 3 W  $\angle 60^\circ$  3000 K 100 lm Ra 80

R12462 preto/cromo

€ 150

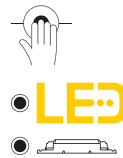
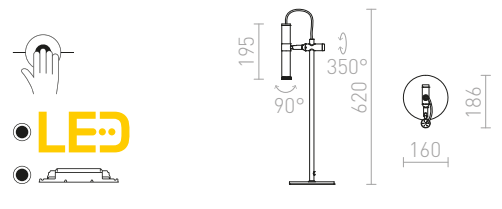

## COZY

Elegante candeeiro de mesa LED sobre tripé em acabamento metálico mate. O transformador faz parte do adaptador do casquilho.

### COZY DE MESA

230 V LED 3,5 W 3000 K 240 lm Ra 80

R11759 níquel mate

€ 58

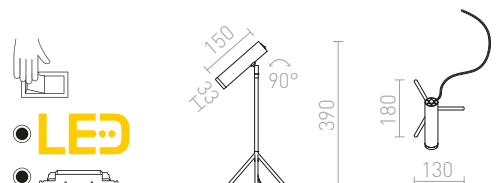



## CANDEEIROS DE PÉ

DECORATIVO 352-367

PARA LEITURA 368-371

# CANDEEIROS DE PÉ DECORATIVO

352-367



**ALVIS/AMBITUS 46**  
352-353



**ALVIS/ILUSION**  
352-353



**AMBITUS 46**  
352-353



**ALVIS/RIDICK**  
352-353



**LUTON/ILUSION**  
354-355



**LUTON/RIDICK**  
354-355



**BOULOGNE**  
354-355



**GARDETTE**  
356-357



**LUTON/RON 55**  
356-357



**NAUTIC**  
356-357



**DANTE**  
358-359



**RITZY**  
358-359



**ESPLANADE**  
358-359



**EDIKA**  
360-361



**ETESIAN**  
360-361



**NYC/ILUSION**  
360-361



**NYC/RON 40/25**  
362-363



**CORTINA/JAKARANDA**  
362-363



**LULU**  
364-365



**NYC/CONNY 25**  
364-365



**NYC/CONNY 35**  
364-365



**PLAZA**  
366-367



**NYC/TEMPO 30/19**  
366-367



**PERTH**  
366-367

# CANDEEIROS DE PÉ PARA LEITURA

368-371



**PRAGMA**  
368-369



**VARIA**  
368-369



**ROSITA**  
368-369



**STIG**  
368-369



**VIPER FL**  
370-371



**BUGSY**  
370-371



**FADO**  
370-371



## ALVIS/AMBITUS

Um candeeiro de pé com um abajur em tecido e uma base em bambu regulável em altura. Adequado para fontes de luz LED E27.

**ALVIS/AMBITUS 46 DE PÉ**

230 V LED E27 11 W

**R14044** branco creme/bambu

€ 320 **NEW**

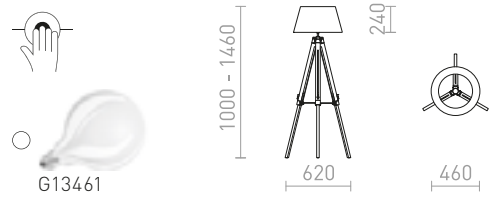

## ALVIS/ILUSION

Um candeeiro de pé com um abajur feito de folha de cromo. Tem uma base em bambu regulável em altura. Adequado para fontes de luz LED E27.

**ALVIS/ILUSION DE PÉ**

230 V LED E27 11 W

**R14045** folha de cromo/bambu

€ 320 **NEW**

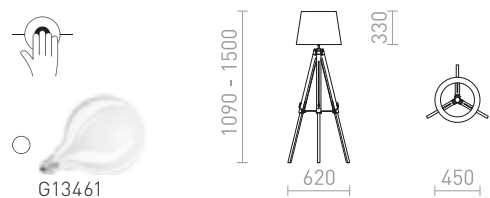



### ALVIS/RIDICK

Um candeeiro de pé com um abajur feita de folha preta brilhante com um lado interior dourado. Tem uma base em bambu regulável em altura. Adequado para fontes de luz LED E27.

#### ALVIS/RIDICK DE PÉ

230 V LED E27 11 W

**R14046** preto brilhante/folha dourada/bambu € 278 NEW

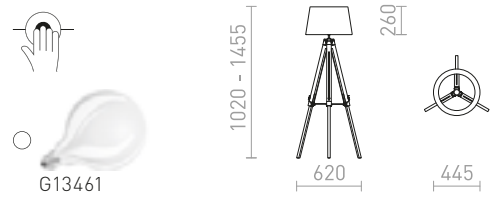

### AMBITUS

Um candeeiro de pé com um abajur em tecido e uma elegante base em bambu. Adequado para fontes de luz LED E27.

#### AMBITUS 46 DE PÉ

230 V LED E27 11 W

**R14043** branco creme/bambu € 380 NEW

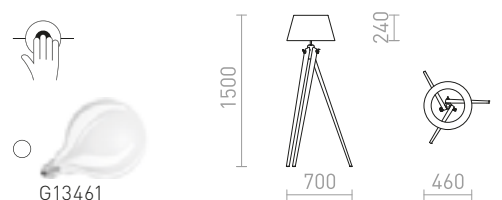





## LUTON/ILUSION

Um candeeiro de pé elegante com um abajur em folha de cromo. Tem uma base de metal lacado regulável em altura com acessórios em latão. Adequado para fontes de luz LED E27.

### LUTON/ILUSION DE PÉ

230 V LED E27 11 W

R14065 folha de cromo/preto/metal

€ 248 **NEW**



G13026

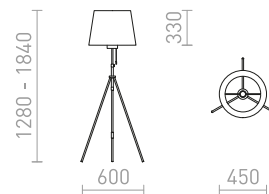

## LUTON/RIDICK

Um candeeiro de pé elegante com um abajur feito de folha preta brilhante com um lado interior dourado. Tem uma base de metal lacado regulável em altura com acessórios em latão. Adequado para fontes de luz LED E27.

### LUTON/RIDICK DE PÉ

230 V LED E27 11 W

R14066 preto brilhante/folha dourada/preto/metal

€ 215 **NEW**



G13026

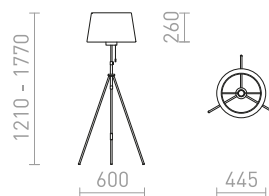

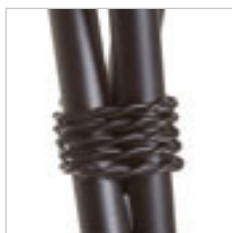

## BOULOGNE

Suporte de tripé com abajur de fita dupla em preto.

### BOULOGNE DE PÉ

230 V E27 28 W

R12674 preto

€ 290 





## GARDETTE

Candeeiro de pé sobre tripé permanente com ajuste de altura e abajur têxtil para casquilhos E27.

**GARDETTE DE PÉ**

230 V E27 42 W

**R12489** preto/alumínio

€ 360 %



G13029

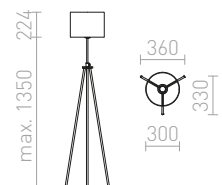



## LUTON/RON

Um candeeiro de pé elegante com um abajur em tecido. Tem uma base em metal lacado regulável em altura com acessórios em latão. Adequado para fontes de luz LED E27.

### LUTON/RON 55 DE PÉ

230 V LED E27 11 W

**R14067** Poli-algodão branco/preto/metal

€ 268 NEW

**R14068** Poli-algodão preto/preto/metal

€ 268 NEW

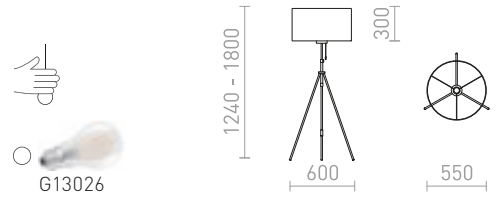

## NAUTIC

Candeeiro de pé de estilo retro sobre tripé e foco ajustável para fontes de luz E27.

### NAUTIC DE PÉ

230 V E27 20 W

**R13394** preto/cromo

€ 178 ➔

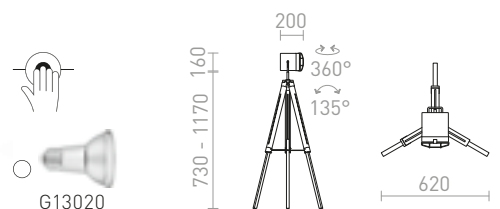



## RITZY

Candeeiro de pé com ajuste para regular a altura, em preto e cromo. Vem com abajur têxtil e casquilho E27.

**RITZY DE PÉ**  
230 V E27 42 W

**R12487** preto/cromo

€ 560 %



G13029

max. 1495 210



660

420



## DANTE

Candeeiro de pé de design maciço adequado para interiores espaçosos. Combinação de madeira, metal e abajur têxtil.

**DANTE DE PÉ**  
230 V E27 25 W

**R13653** preto/madeira

€ 620



G13461

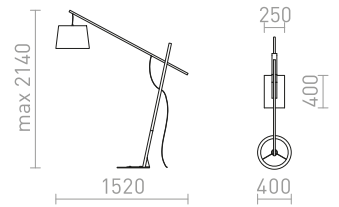

## ESPLANADE

Candeeiro de pé com suporte ajustável e abajur têxtil duplo.

**ESPLANADE DE PÉ**  
230 V E27 42 W

**R12485** preto transparente/branco/cromo

€ 520



G13029

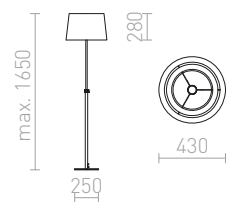



## EDIKA

Candeeiro de pé em níquel com perna telescópica e abajur têxtil com casquilho E27.

**EDIKA DE PÉ**  
230 V E27 42 W

**R12666** castanho/níquel mate

€ 198 ➔

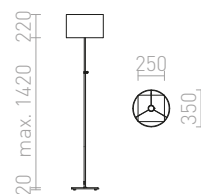

## NYC/ILUSION

Um candeeiro de pé com uma base cromada e um abajur em folha cromada. Adequado para fontes de luz LED E27.

**NYC/ILUSION DE PÉ**  
230 V LED E27 11 W

**R14073** folha de cromo/cromo

€ 198 NEW

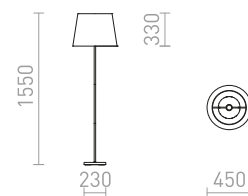

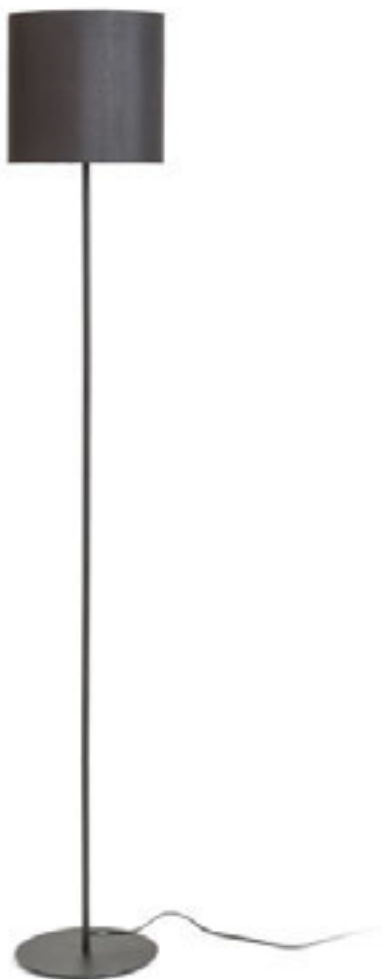

## ETESIAN

Candeeiro de pé subtil com abajur têxtil e casquilho E27.

**ETESIAN DE PÉ**

230 V E27 28 W

**R12470** preto

**€ 178**

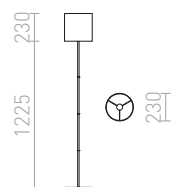





## CORTINA/JAKARANDA

Um candeeiro de pé com uma base em metal lacado e um abajur em tecido com uma superfície geométrica 3D. Adequado para fontes de luz LED E27.

### CORTINA/JAKARANDA DE PÉ

230 V LED E27 11 W

**R14069** branco/branco/têxtil/metal

€ 188 NEW

**R14070** preto/branco/têxtil/metal

€ 188 NEW

**R14071** branco/preto/têxtil/metal

€ 188 NEW

**R14072** preto/preto/têxtil/metal

€ 188 NEW



G13026

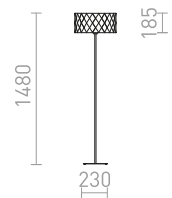



## NYC/RON

Um candeeiro de pé com uma base cromada e um abajur em tecido. Adequado para fontes de luz LED E27.

### NYC/RON 40/25 DE PÉ

230 V LED E27 11 W

	<b>R14079</b> Polí-algodão branco/cromo	€ 188 <b>NEW</b>
	<b>R14080</b> Alperce de chita/cromo	€ 188 <b>NEW</b>
	<b>R14081</b> Chita cinza claro/cromo	€ 188 <b>NEW</b>
	<b>R14082</b> monaco pomba gris/prata PVC/cromo	€ 248 <b>NEW</b>
	<b>R14083</b> monaco gasolina azul/prata PVC/cromo	€ 248 <b>NEW</b>
	<b>R14084</b> Polí-algodão preto/cromo	€ 188 <b>NEW</b>

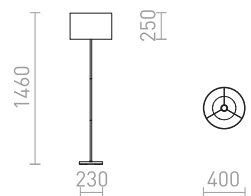



## LULU

Candeeiro de pé com abajur cônico têxtil e casquilho E27. A base tem uma elegante combinação de cromo e preto.

### LULU DE PÉ

230 V E27 28 W

**R12466** branco/preto/cromo

€ 238

**R12467** preto/cromo

€ 238



G13029

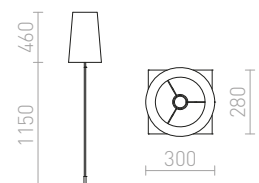



## NYC/CONNY

Um candeeiro de pé com uma base cromada e um abajur em tecido. Adequado para fontes de luz LED E27.

### NYC/CONNY 25 DE PÉ

230 V LED E27 7 W



**R14074**

Poli-algodão branco/cromo

€ 178 **NEW**

**R14075**

monaco gasolina azul/prata PVC/cromo

€ 229 **NEW**



G13026

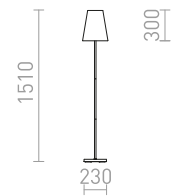

250



## NYC/CONNY

Um candeeiro de pé com uma base cromada e um abajur em tecido. Adequado para fontes de luz LED E27.

### NYC/CONNY 35 DE PÉ

230 V LED E27 11 W



**R14076**

Poli-algodão branco/cromo

€ 198 **NEW**

**R14077**

monaco pomba gris/prata PVC/cromo

€ 278 **NEW**

**R14078**

monaco gasolina azul/prata PVC/cromo

€ 278 **NEW**



G13026

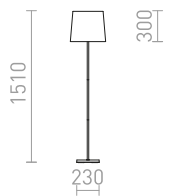

350



## NYC/TEMPO

Um candeeiro de pé com uma base cromada e um abajur em tecido. Adequado para fontes de luz LED E27.

### NYC/TEMPO 30/19 DE PÉ

230 V LED E27 11 W

R14085 Poli-algodão branco/cromo

€ 188 **NEW**



G13026

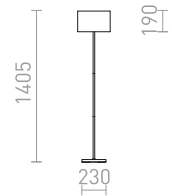

300



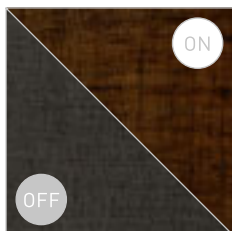
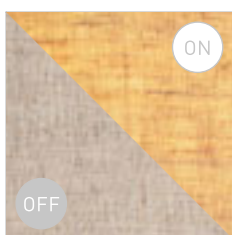

## PERTH

Candeeiro de pé com abajur angular em tecido e base metálica.

**PERTH DE PÉ**  
230 V E27 20 W

**R13665** bege/branco

€ 268

**R13666** preto/preto

€ 268



G13029

1550



270

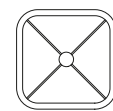

370



## PLAZA

Candeeiro de pé com abajur têxtil texturado.

**PLAZA DE PÉ**  
230 V E27 42 W

**R11984** branco/cromo

€ 620



G13026

1400



230

220

400

300x150



## STIG

Elegante candeeiro de pé LED em preto com uma junta em latão. A intensidade da luz pode ser alterada através de um interruptor no cabo entre: 10%, 40% ou 100%.

### STIG DE PÉ

230 V LED 8,4 W  $\angle 34^\circ$  3000 K 447 lm Ra 80

R13942 preto

€ 238 **NEW**

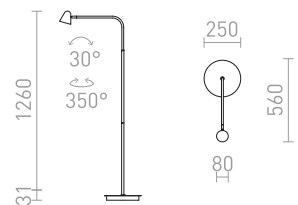

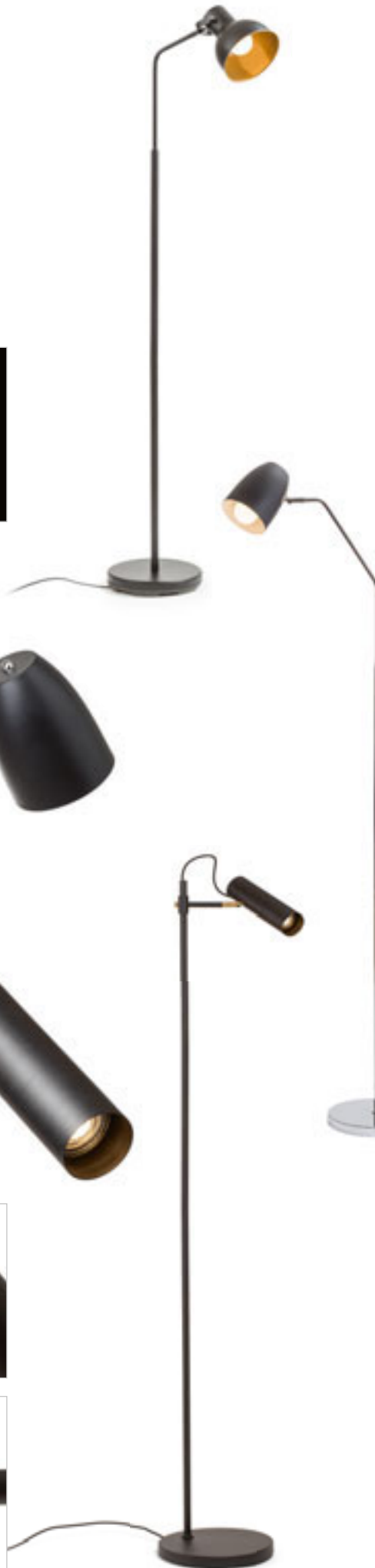
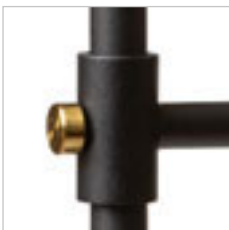

## ROSITA

Candeeiro de pé de estilo retro para fontes de luz E27.

### ROSITA DE PÉ

230 V E27 12 W

R12514 preto/ouro

€ 158 %



G13014

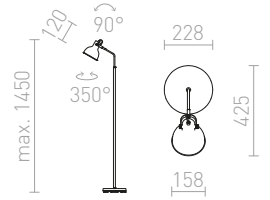

## PRAGMA

Candeeiro de pé com casquilho E27.

### PRAGMA DE PÉ

230 V E27 28 W

R12989 preto/cromo

€ 150 ▶



G13014

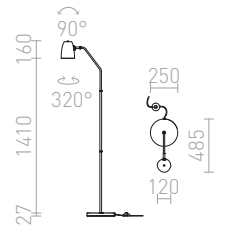

## VARIA

Luminária de pé elegante com refletor cilíndrico para fonte de luz LED com casquilho GU10. A chave está localizada na parte traseira do refletor.

### VARIA DE PÉ

230 V LED GU10 9 W

R13660 preto/latão

€ 198



G11841

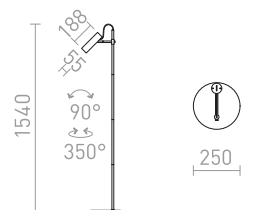





## VIPER

Candeeiro de pé cromado com dois focos LED pretos ajustáveis, que podem ser controlados individualmente por interruptores colocados sobre cabos têxteis vermelhos. Ambos os cabos possuem tomadas individuais.

### VIPER FL DE PÉ

230 V LED 2x3 W  $\angle 60^\circ$  3000 K 200 lm Ra 80

R12463 preto/cromo

€ 248 %

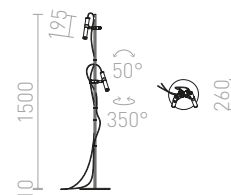

## FADO

Candeeiro de pé com design angular e dois focos LED ajustáveis.

### FADO DE PÉ

230 V LED 2x3 W  $\angle 45^\circ$  3000 K 220 lm Ra 80

R12475 preto

€ 278 %

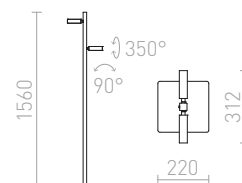

## BUGSY

Candeeiro de pé com abajures de vidro espelhado. Cada abajur pode ser inclinado em um eixo.

### BUGSY DE PÉ

230 V GU10 3x50 W

R10520 vidro cromado

€ 178 %

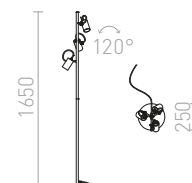
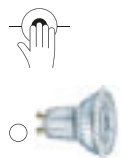

G11841





## LUZES EMBUTIDAS

MODULAR	384-389
LED DE CASA DE BANHO	390-397
CASA DE BANHO	398-405
DECORATIVO	406-417
GESSO	418-427
SEM MOLDURA	428-431
CONJUNTOS	432-441
CIRCULAR	442-443
ANGULAR	444-447
FINO	448-463
PARA PAREDE	464-481



## EMBUTIDO MODULAR



**SHARM BASE**  
384-385



**SHARM PLUS**  
384-385



**SHARM R I**  
386-387

384-389



**SHARM R II**  
386-387



**SHARM R III**  
386-387



**SHARM SQ I**  
388-389



**SHARM SQ II**  
388-389



**SHARM SQ III**  
388-389

## EMBUTIDO LED DE CASA DE BANHO



**RINO**  
390-391



**WATERBOY R**  
390-391



**WATERBOY SQ**  
390-391

390-397



**NAVY**  
390-391



**INEZ R**  
392-393



**INEZ SQ**  
392-393



**MERGO R**  
392-393



**BELLA LED**  
392-393



**AMIGA R**  
394-395



**AMIGA SQ**  
394-395



**TOLEDO R**  
394-395



**TOLEDO SQ**  
394-395



**OWEN**  
394-395



**BELI R 10**  
396-397



**BELI R 21**  
396-397



**BELI SQ 10**  
396-397



**BELI SQ 21**  
396-397

## EMBUTIDO CASA DE BANHO

398-405



**MAJESTIC**  
398-399



**EQUA**  
398-399



**APRIORI**  
398-399



**BERMUDA**  
398-399



**ACUA**  
400-401



**BELLA GU10**  
400-401



**VERO**  
400-401



**ASTOR SQ**  
402-403



**SPLASH R**  
402-403



**SPLASH SQ**  
402-403



**LEROY R**  
404-405



**LEROY SQ**  
404-405



**INCA R**  
404-405



**ISLA**  
404-405



**BRAN**  
404-405

## EMBUTIDO DECORATIVO

406-417



**MARENGA RB1 40**  
406-407



**MARENGA SQB1 40**  
406-407



**MARENGA RR1 40**  
408-409



**MARENGA RR3 60**  
408-409



**MARENGA RR4 90**  
408-409



**MARENGA SQR3 60**  
408-409



**MARENGA RD4 52**  
410-411



**MARENGA RD3 60**  
410-411



**MARENGA RD1 73**  
410-411



**MARENGA RW1 30**  
412-413



**MARENGA RT1 40**  
412-413



**MARENGA RL1 40**  
412-413



**MARENGA RD5 28**  
414-415



**MARENGA RD6 96**  
414-415



**MARENGA RC1 98**  
414-415



**MARENGA RW2 60**  
414-415



**KAY SQ**  
416-417



**KAY R**  
416-417



**BIANCA SQ**  
416-417

## EMBUTIDO GESSO



**DAG R 83**  
418-419



**DANDY R**  
418-419



**QUO R**  
418-419



**QUO R II**  
418-419



**DANDY SQ**  
420-421



**QUO SQ I**  
420-421



**QUO SQ II**  
420-421



**DINGO S**  
422-423



**DINGO GU10 II**  
422-423



**DINGO R**  
424-425



**DINGO II**  
424-425



**DINGO TUB**  
426-427



**DINO SQ G53**  
426-427



**DINO SQ GU10**  
426-427



**DAN SQ 80**  
426-427



**MIA R**  
426-427



## EMBUTIDO SEM MOLDURA



**IPSO SQ frameless**  
428-429



**IPSO R frameless**  
428-429



**IPSO R**  
428-429

428-431



**COIMBRA**  
428-429



**ELECTRA I**  
430-431



**ELECTRA I**  
430-431



**ELECTRA II**  
430-431

## EMBUTIDO CONJUNTOS



**ZIZI I**  
432-433



**ZIZI II**  
432-433



**KELLY LED**  
432-433

432-441



**KELLY LED**  
432-433



**SPRAY 9**  
434-435



**SPRAY 11**  
434-435



**GRANADA SQ**  
434-435



**PASADENA G53 R I**  
436-437



**PASADENA G53 SQ I**  
436-437



**PASADENA G53 SQ II**  
436-437



**PASADENA GU10 SQ I**  
436-437



**PASADENA GU10 SQ II**  
436-437



**LIZARD I**  
438-439

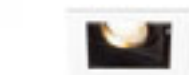

**BONDY I**  
438-439



**BONDY II**  
438-439



**BONDY III**  
438-439



**FIZZ III**  
440-441



**MONE I**  
440-441



**MONE II**  
440-441

**MONE III**  
440-441

## EMBUTIDO CIRCULAR



442-443

**VIP**  
442-443

**SOBER**  
442-443

**TOPIC R**  
442-443



**MIRO**  
442-443

**REWA**  
442-443

## EMBUTIDO ANGULAR



444-447

**TECH I**  
444-445

**LEDA**  
444-445

**TIM**  
444-445



**MERIKO GU10**  
446-447

**TOPIC SQ**  
446-447

**ACASA**  
446-447

**ZURI SQ**  
446-447

**MURO SQ**  
446-447

## EMBUTIDO FINO



448-463

**BJORK R 9**  
448-449

**BJORK R 16**  
448-449

**BJORK R 20**  
448-449



**BJORK SQ 9**  
448-449



**BJORK SQ 20**  
448-449



**DADA 9**  
450-451



**DADA 12**  
450-451



**DADA 17**  
450-451



**DADA 23**  
450-451



**DADA 30**  
450-451



**HUE R 9**  
452-453



**HUE R 17**  
452-453



**HUE R 22**  
452-453



**HUE R 9**  
454-455



**HUE R 17**  
454-455



**HUE R 22**  
454-455



**HUE SQ 9**  
456-457



**HUE SQ 17**  
456-457



**HUE SQ 22**  
456-457



**HUE SQ 9**  
458-459

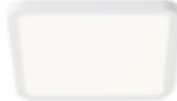

**HUE SQ 17**  
458-459



**HUE SQ 22**  
458-459



**SOCORRO R 85**  
460-461



**SOCORRO R 225**  
460-461



**SLENDER SQ 8**  
460-461



**PESANTE 90**  
462-463



**STRUCTURAL LED 40x40**  
462-463

## EMBUTIDO PARA PAREDE

464-481



**IRIA R**  
464-465



**IRIA SQ**  
464-465



**SEGNO**  
464-465



**ELICA R**  
466-467



**ELICA SQ**  
466-467



**MEMPHIS R**  
466-467



**MEMPHIS SQ**  
466-467



**RIO SQ 0**  
468-469



**RIO R**  
468-469



**RIO SQ**  
468-469



**CLUB IND**  
470-471



**CLUB**  
470-471



**MARCO**  
470-471



**ASTERIA**  
470-471



**KICK I**  
472-473



**KICK II**  
472-473



**KICK III**  
472-473



**AMARO**  
474-475



**TESS SQ**  
474-475



**PER**  
474-475



**INTRO L**  
476-477



**RAGG**  
476-477



**RASQ**  
476-477



**GORDIQ S**  
478-479



**GORDIQ M**  
478-479



**GORDIQ L**  
478-479



**DEJAVU SQ 9**  
480-481



**DEJAVU SQ 14**  
480-481

## SHARM

Sistema Modular Profissional SHARM LED - até 2500 combinações para versões de luminárias simples, duplas ou triplas. Módulos 5/10W, 3000/4000K, lentes com ângulo de radiação de 12° e 24°, dois tipos de difusores em 5 cores diferentes, anel de ornamento curvo ou reto em 7 cores (não requerido), bases arredondadas ou iguais em 3 cores (não necessárias).

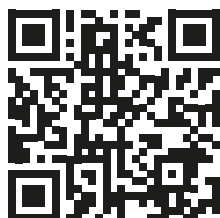

Use esse código para acessar o nosso site, onde você poderá ver e montar o seu (Spotlight) de acordo com as suas necessidades. Este configurador oferece mais de 2500 combinações para escolher.







### SHARM

Luminária fixa embutida com módulo 10W LED.  
Disponível em várias cores.

#### SHARM BASE EMBUTIDA

230 V LED 10 W  $\angle 24^\circ$  3000 K 900lm Ra 80

R13221	branco	€ 48
R13222	ouro pérola	€ 48
R13223	castanho	€ 48
R13224	preto	€ 48
R13225	cromo	€ 48
R13226	cobre	€ 48
R13227	cromo preto	€ 48

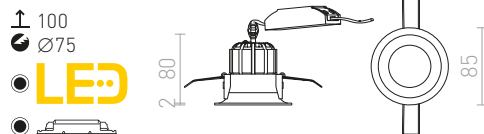

### SHARM

Luminária fixa embutida com módulo 10W LED.  
Disponível em várias cores.

#### SHARM PLUS EMBUTIDA

230 V LED 10 W  $\angle 24^\circ$  3000 K 900lm Ra 80

R13228	branco	€ 48
R13229	ouro pérola	€ 48
R13230	castanho	€ 48
R13231	preto	€ 48
R13232	cromo	€ 48
R13233	cobre	€ 48
R13234	cromo preto	€ 48

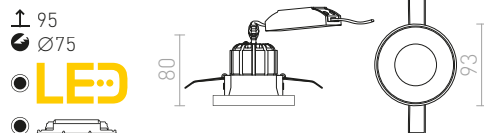





## SHARM

Luminária fixa embutida com módulo 10W LED. Com este código QR pode aceder ao nosso site onde poderá montar confortavelmente até 2500 combinações ao seu gosto. [www.rendl.pt/pt/configurador/](http://www.rendl.pt/pt/configurador/)

### SHARM R I EMBUTIDA

230 V LED 10 W  $\angle 24^\circ$  3000 K 900 lm Ra 80

<b>R13235</b> branco/cobre	€ 58
<b>R13236</b> ouro pérola/castanho	€ 58
<b>R13237</b> castanho/ouro pérola	€ 58
<b>R13238</b> preto/cobre/cobre	€ 58
<b>R13239</b> preto/preto/cobre	€ 58

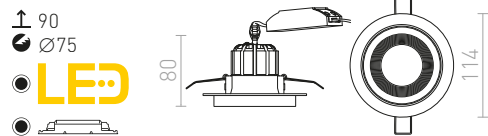

### SHARM R II EMBUTIDA

230 V LED 2x10 W  $\angle 24^\circ$  3000 K 1800 lm Ra 80

<b>R13240</b> branco/cobre	€ 98
<b>R13241</b> ouro pérola/castanho	€ 98
<b>R13242</b> castanho/ouro pérola	€ 98
<b>R13243</b> preto/cobre/cobre	€ 98
<b>R13244</b> preto/preto/cobre	€ 98

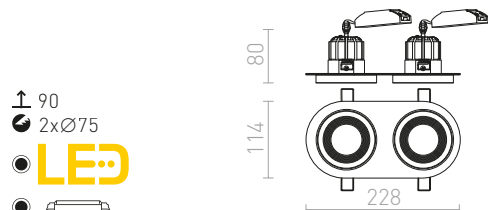



## SHARM

Luminária fixa embutida com módulo 10W LED. Com este código QR pode aceder ao nosso site onde poderá montar confortavelmente até 2500 combinações ao seu gosto. [www.rendl.pt/pt/configurador/](http://www.rendl.pt/pt/configurador/)

### SHARM R III EMBUTIDA

230 V LED 3x10 W  $\angle 24^\circ$  3000 K 2700 lm Ra 80

**R13245** branco/cobre € 138

**R13246** ouro pérola/castanho € 138

**R13247** castanho/ouro pérola € 138

**R13248** preto/cobre/cobre € 138

**R13249** preto/preto/cobre € 138

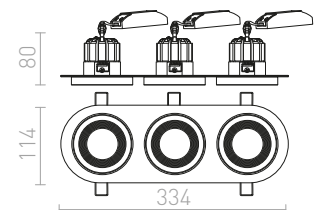
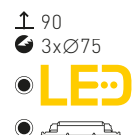
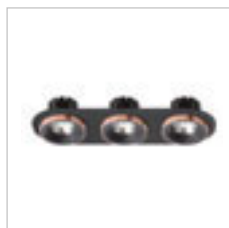
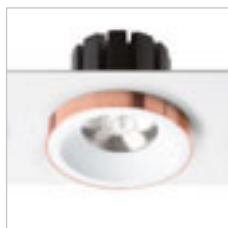



## SHARM

Luminária fixa embutida com módulo 10W LED. Com este código QR pode aceder ao nosso site onde poderá montar confortavelmente até 2500 combinações ao seu gosto. [www.rendl.pt/pt/configurador/](http://www.rendl.pt/pt/configurador/)

### SHARM SQ I EMBUTIDA

230 V LED 10 W  $\angle 24^\circ$  3000 K 900 lm Ra 80

<b>R13250</b> branco/cobre	€ 58
<b>R13251</b> ouro pérola/castanho	€ 58
<b>R13252</b> castanho/ouro pérola	€ 58
<b>R13253</b> preto/cobre/cobre	€ 58
<b>R13254</b> preto/preto/cobre	€ 58

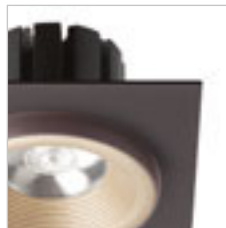
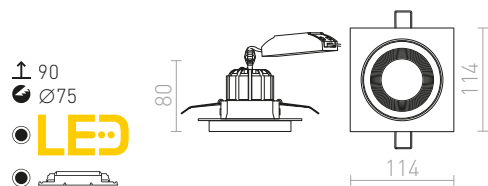

WEB  
CONFIGURATOR

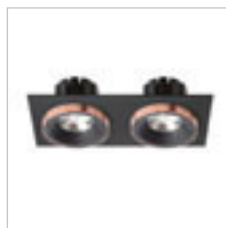

### SHARM SQ II EMBUTIDA

230 V LED 2x10 W  $\angle 24^\circ$  3000 K 1800 lm Ra 80

<b>R13255</b> branco/cobre	€ 98
<b>R13256</b> ouro pérola/castanho	€ 98
<b>R13257</b> castanho/ouro pérola	€ 98
<b>R13258</b> preto/cobre/cobre	€ 98
<b>R13259</b> preto/preto/cobre	€ 98

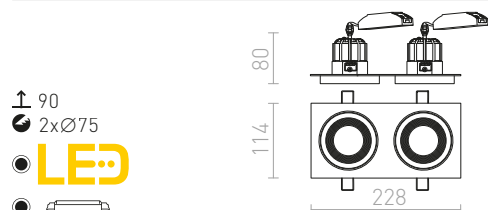



## SHARM

Luminária fixa embutida com módulo 10W LED. Com este código QR pode aceder ao nosso site onde poderá montar confortavelmente até 2500 combinações ao seu gosto. [www.rendl.pt/pt/configurador/](http://www.rendl.pt/pt/configurador/)

### SHARM SQ III EMBUTIDA

230 V LED 3x10 W  $\angle 24^\circ$  3000 K 2700 lm Ra 80

<b>R13260</b> branco/cobre	€ 138
<b>R13261</b> ouro pérola/castanho	€ 138
<b>R13262</b> castanho/ouro pérola	€ 138
<b>R13263</b> preto/cobre/cobre	€ 150
<b>R13264</b> preto/preto/cobre	€ 138

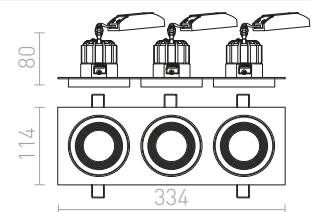
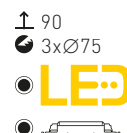



IP65



## NAVY

Luminária LED maciça para instalação em tetos exteriores.

### NAVY EMBUTIDA

230 V LED 15 W  $\angle 36^\circ$  2700 K 1100 lm Ra 80 IP65

R12661 branco

€ 120 %

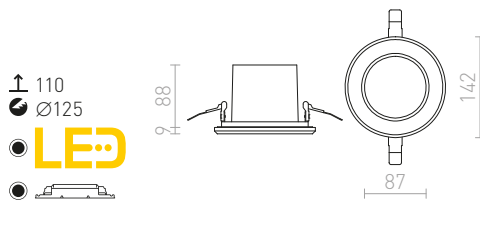

IP65



## RINO

Luz de metal embutida com capas intercambiáveis adequadas para ambientes húmidos. Capa frontal vendida separadamente.

### RINO

#### EMBUTIDO SEM TAMPA

230 V LED 10 W  $\angle 36^\circ$  3000 K 760 lm Ra 80 IP65

R11682

€ 38 %

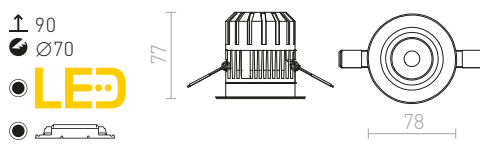

## RINO

Capa frontal para RINO.

### RINO CAPA DECORATIVA

R11683 branco

€ 9.35

R11684 cromo

€ 11.50 %

R11685 ouro

€ 14.50 %

R11686 níquel mate

€ 11.50 %

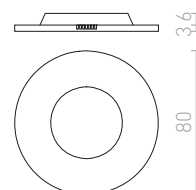

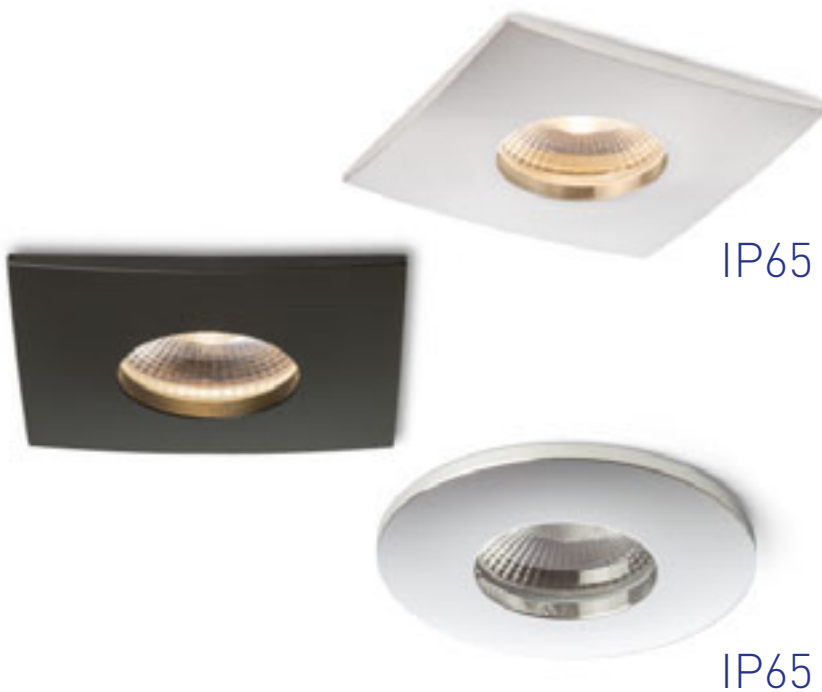

### WATERBOY

Luz embutida de alumínio LED adequada para ambientes húmidos. Disponível em várias versões.

#### WATERBOY SQ

230 V LED 10 W  $\angle 40^\circ$  3000 K 550 lm Ra 80 IP65

**R11728** mate branco € 78

**R11729** níquel mate € 78

**R11730** cromo € 78

**R11741** mate preto € 78

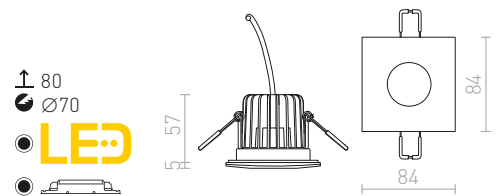

#### WATERBOY R

230 V LED 10 W  $\angle 40^\circ$  3000 K 550 lm Ra 80 IP65

**R11725** mate branco € 78

**R11726** níquel mate € 78

**R11727** cromo € 78

**R11740** mate preto € 78

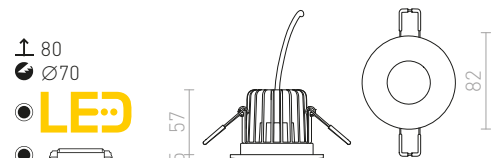



IP65



## BELLA

Iluminação LED embutida de casa de banho para tetos falsos em gesso cartonado com reflector embutido.

### BELLA LED EMBUTIDA

230 V LED 11 W  $\angle 40^\circ$  3000 K 940 lm Ra 90 IP65

R13602 branco

€ 68

↑ 70  
● Ø68

● LED

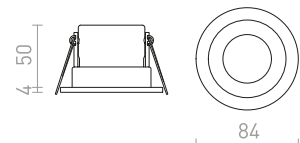



IP44



IP44



IP44



### INEZ

Luz LED com uma baixa profundidade de reentrância. A luminária é adequada para a inserção em móveis.

#### INEZ R

12 V= LED 3 W 3000 K 170 lm Ra 80 IP44

R10586 cromo

€ 35

↑ 15  
● Ø56

● LED

○ G14018

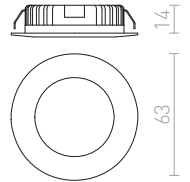

#### INEZ SQ

12 V= LED 3 W 3000 K 170 lm Ra 80 IP44

R10587 cromo

€ 19

↑ 15  
● Ø56

● LED

○ G14018

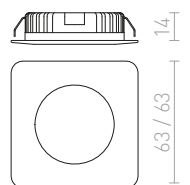

### MERGO

Luz embutida LED para ambientes húmidos.

#### MERGO R EMBUTIDA

230 V LED 6,5 W 3000 K 535 lm Ra 80 IP44

R10572 cromo

€ 28

↑ 75  
● Ø72

● LED

○ G14018

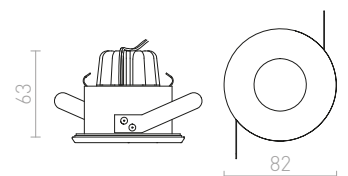





IP65



IP65



## AMIGA

Luminária embutida com LED integrado para ambientes húmidos. Regulação da intensidade da luz TRIAC.

### AMIGA R DIMM

230 V LED 8 W  $\angle 40^\circ$  3000 K 580 lm Ra 80 IP65

R10565 branco

€ 120

± 110

Ø96

LED

regulável

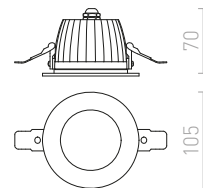

### AMIGA SQ DIMM

230 V LED 8 W  $\angle 40^\circ$  3000 K 580 lm Ra 80 IP65

R10566 branco

€ 120

± 110

Ø96

LED

regulável

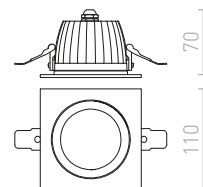

IP44



IP44



## TOLEDO

Luminária embutida LED para tetos de gesso adequada para ambientes húmidos.

### TOLEDO R

230 V LED 7 W  $\angle 60^\circ$  3000 K 514 lm Ra 80 IP44

R12716 branco

€ 78

± 70

Ø70

LED

regulável

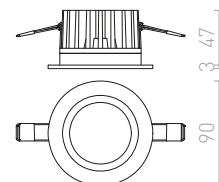

### TOLEDO SQ

230 V LED 7 W  $\angle 60^\circ$  3000 K 513 lm Ra 80 IP44

R12717 branco

€ 78

± 70

Ø70

LED

regulável

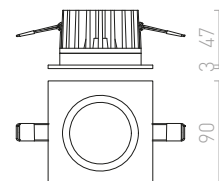



IP54

## OWEN

Luminária embutida LED regulável com controlo de cor e intensidade de luz - DIMM TO WARM. Faixa de cores claras 3000K - 1800K. É necessário um teto de gesso para a instalação. Adequado para ambientes húmidos. Regulação da intensidade da luz TRIAC.

### OWEN DIMM EMBUTIDA

230V LED 7W  $\angle 45^\circ$  3000 K - 1800 K 520 lm Ra 90 IP54

R13667 branco

€ 78

R13668 preto

€ 78

↑ 110

● Ø55

● LED

● regulável



1800K → 3000K  
DIMM TO WARM

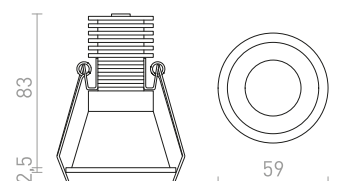





IP65



### BELI

Luminária embutida sem moldura. Difusor de luz acrílico fosco levemente convexo. Adequada para áreas húmidas.

#### BELI R 10 EMBUTIDA

230 V LED 6 W 3000 K 520 lm Ra 80 IP65

R13430 acrílico fosco

€ 29

↑ 40  
● Ø80

● LED

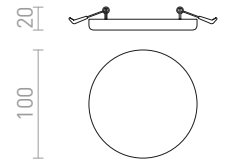

#### BELI R 21 EMBUTIDA

230 V LED 24 W 3000 K 2200 lm Ra 80 IP65

R13432 acrílico fosco

€ 68

↑ 40  
● Ø195

● LED

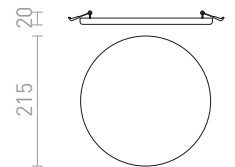

IP65



### BELI

Luminária embutida sem moldura. Difusor de luz acrílico fosco levemente convexo. Adequada para áreas húmidas.

#### BELI SQ 10 EMBUTIDA

230 V LED 6 W 3000 K 645 lm Ra 80 IP65

R13521 acrílico fosco

€ 32

↑ 40  
■ 80x80

● LED

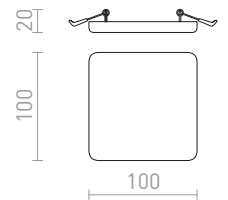

#### BELI SQ 21 EMBUTIDA

230 V LED 24 W 3000 K 2299 lm Ra 80 IP65

R13522 acrílico fosco

€ 78

↑ 40  
■ 190x190

● LED

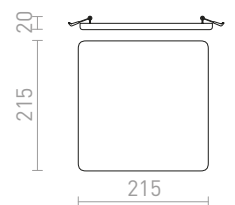



IP54



## EQUA

Luminária redonda embutida de casa de banho para casquilho GU10. Apenas para tetos em gesso.

### EQUA

230 V GU10 35 W IP54

R12746 cromo

€ 11 %

↑ 100  
● Ø75



G11841

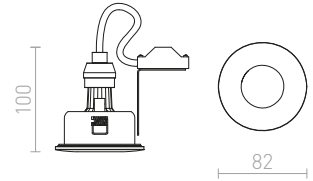

IP54



## APRIORI

Luminária redonda embutida de casa de banho para casquilho GU10. Apenas para tetos em gesso.

### APRIORI

230 V GU10 35 W IP54

R12747 branco/vidro acetinado

€ 22

↑ 140  
● Ø75



G11841

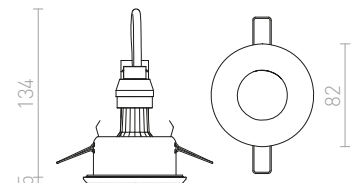

IP44



## MAJESTIC

Luminária redonda embutida de casa de banho para casquilho GU10. Apenas para tetos em gesso.

### MAJESTIC

230 V GU10 35 W IP44

R12911 alumínio escovado

€ 26 %

↑ 130  
● Ø65



G11841

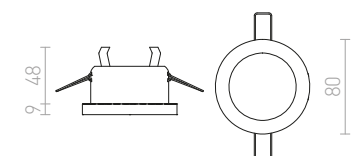



IP65



## BERMUDA

Luminária redonda embutida de casa de banho para casquilho GU10. Apenas para tetos em gesso.

### BERMUDA EMBUTIDA

230 V GU10 35 W IP65

R12749 branco

€ 22

R13604 preto

€ 22

↑ 150  
● Ø75



G11841

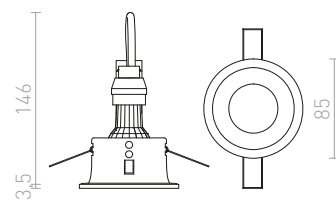



IP44



## VERO

Foco embutido adequado para ambientes húmidos. A cobertura de vidro tem a parte central acetinada. Necessita de transformador apropriado (vendido separadamente).

**VERO EMBUTIDA**  
12V GU5,3 50W IP44

**R10395/12** cromo

€ 38 %

↑ 110  
● Ø95

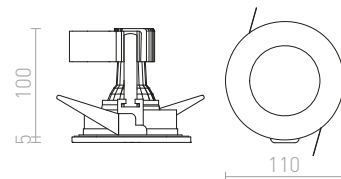
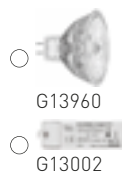

IP44



## VERO

Foco embutido adequado para ambientes húmidos. A cobertura de vidro tem a parte central acetinada.

**VERO EMBUTIDA**  
230V GU10 50W IP44

**R10395** cromo

€ 38 %

↑ 110  
● Ø95

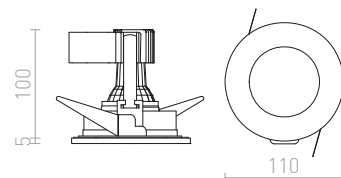



IP65



## BELLA

Iluminação de banho de embutir para tetos falsos de gesso cartonado com reflector encastrado, para fontes de luz LED com casquilho GU10.

### BELLA GU10 EMBUTIDA

230 V LED GU10 15 W IP65

**R13598** branco € 24

**R13599** preto € 24

**R13600** cromo € 28

**R13601** níquel mate € 28

↑ 140  
 ● Ø68



G11841

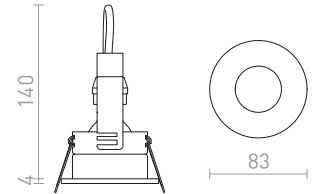

IP44



## ACUA

Foco embutido adequado para ambientes húmidos. Cobertura de vidro acetinado.

### ACUA EMBUTIDA

230 V GU10 50 W IP44

**R10407** branco € 18 %

↑ 120  
 ● Ø85



G11841

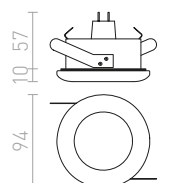





IP65

## SPLASH

Luz metálica embutida adequada para ambientes húmidos. Disponível em cromo polido ou com acabamento de níquel cetim.

### SPLASH R EMBUTIDA

230 V GU10 50 W IP65

R11733 cromo

€ 19

R11734 níquel mate

€ 18.50

120  
Ø70



G11841

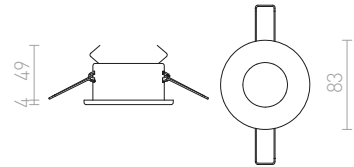

### SPLASH SQ EMBUTIDA

230 V GU10 50 W IP65

R11735 cromo

€ 22

R11736 níquel mate

€ 22

120  
Ø70



G11841

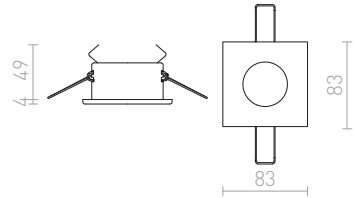

IP65





IP65



## ASTOR

Luminária embutida com moldura em alumínio escovado. A cobertura em vidro tem a parte central acetinada. Adequada para ambientes húmidos.

### ASTOR SQ

230 V GU10 50 W IP65

R10574 alumínio escovado

€ 24

↑ 100  
● Ø60



G11841

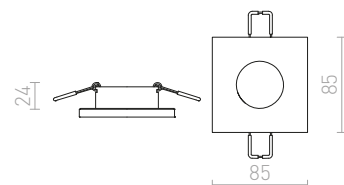



IP65



## INCA

Luminária de casa de banho embutida com casquilho GU10 para fontes de luz LED. Apenas para paredes em gesso.

### INCA R

230 V GU10 7 W IP65

R12657 branco

€ 29

↑ 150  
● Ø70



G11841

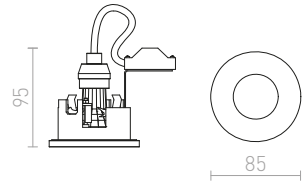

IP65



## BRAN

Iluminação de casa de banho para embutir em tetos falsos em gesso cartonado, sem moldura, para fontes de luz LED com casquilho GU10.

### BRAN EMBUTIDA

230 V LED GU10 15 W IP65

R13605 branco

€ 28

↑ 140  
● Ø80



G11841

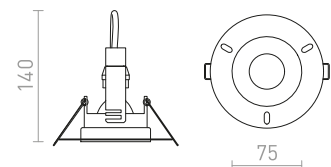

IP65



## ISLA

Iluminação de embutir para tetos falsos em gesso cartonado, com reflector redondo, para fontes de luz LED com casquilho GU10.

### ISLA EMBUTIDA

230 V LED GU10 15 W IP65

R13603 branco

€ 18

↑ 140  
● Ø70



G11841

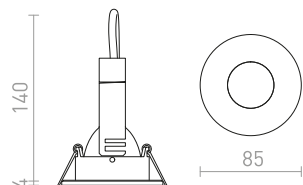



IP44

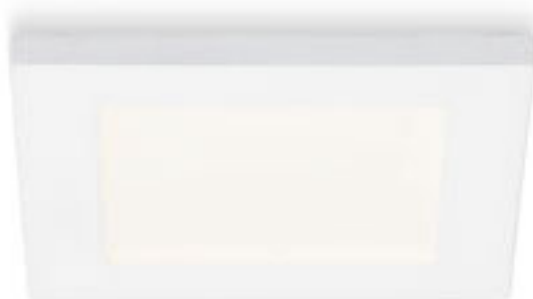

IP44



### LEROY

Luminária de casa de banho embutida com casquilho GU5.3 para fontes de luz 12V. Apenas para paredes em gesso.

#### LEROY R

12 V GU5,3 35 W IP44

R12659 branco

€ 48

↑ 150  
● Ø80

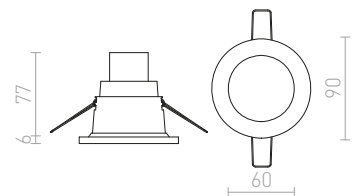
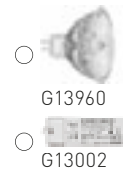

#### LEROY SQ

12 V GU5,3 35 W IP44

R12660 branco

€ 48

↑ 150  
■ 76x76

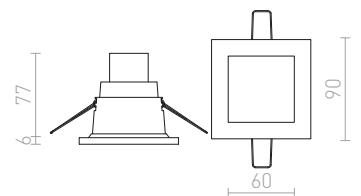
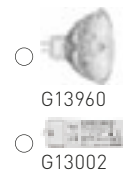





## MARENGA

Candeeiro LED de encastrar para teto em pladur com uma profundidade de encastramento reduzida e um abajur decorativo. O abajur é criado por impressão 3D. Feito de material PLA ecológico, que é totalmente degradável. O tamanho do furo de montagem pode ser ajustado usando as molas de fixação deslizantes. A lâmpada pode substituir convenientemente as lâmpadas halógenas existentes sem a necessidade de modificar os orifícios de montagem.

### MARENGA RB1 40 EMBUTIDA

230 V LED 6 W 3000 K 570 lm Ra 80

R14011 branco/Eco PLA

€ 68 **NEW**

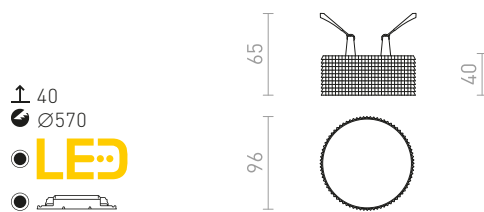

### MARENGA SQB1 40 EMBUTIDA

230 V LED 6 W 3000 K 640 lm Ra 80

R14016 branco/Eco PLA

€ 68 **NEW**

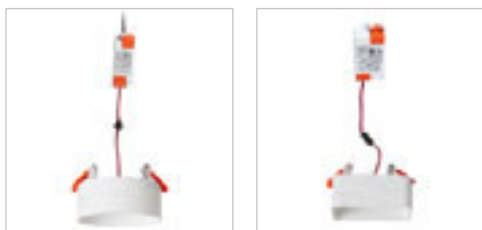
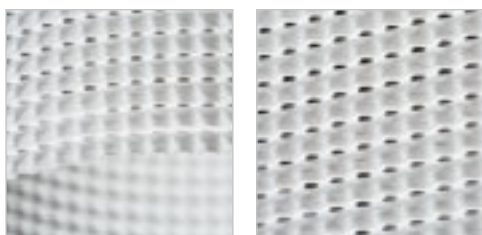
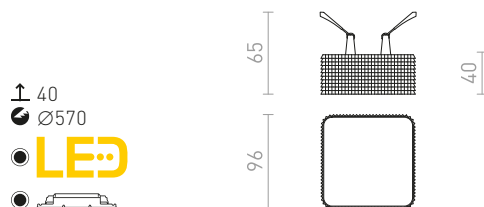



## MARENGA

Candeeiro LED de encastrar para teto em pladur com uma profundidade de encastramento reduzida e um abajur decorativo. O abajur é criado por impressão 3D. Feito de material PLA ecológico, que é totalmente degradável. O tamanho do furo de montagem pode ser ajustado usando as molas de fixação deslizantes. A lâmpada pode substituir convenientemente as lâmpadas halógenas existentes sem a necessidade de modificar os orifícios de montagem.

### MARENGA RR1 40 EMBUTIDA

230 V LED 6 W 3000 K 570 lm Ra 80

R14002 branco/Eco PLA

€ 68 **NEW**

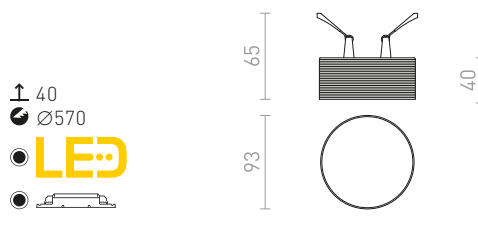

### MARENGA RR3 60 EMBUTIDA

230 V LED 6 W 3000 K 570 lm Ra 80

R14003 branco/Eco PLA

€ 78 **NEW**

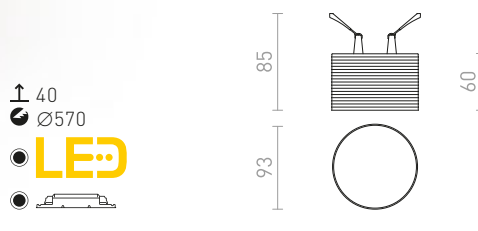

### MARENGA RR4 90 EMBUTIDA

230 V LED 6 W 3000 K 570 lm Ra 80

R14004 branco/Eco PLA

€ 78 **NEW**

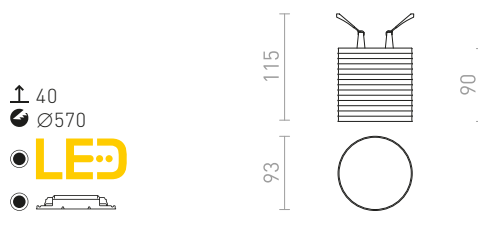

### MARENGA SQR3 60 EMBUTIDA

230 V LED 6 W 3000 K 640 lm Ra 80

R14017 branco/Eco PLA

€ 78 **NEW**

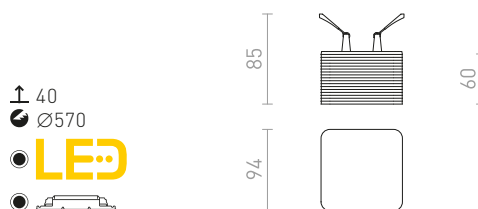









## MARENGA

Candeeiro LED de encastrar para teto em pladur com uma profundidade de encastramento reduzida e um abajur decorativo. O abajur é criado por impressão 3D. Feito de material PLA ecológico, que é totalmente degradável. O tamanho do furo de montagem pode ser ajustado usando as molas de fixação deslizantes. A lâmpada pode substituir convenientemente as lâmpadas halógenas existentes sem a necessidade de modificar os orifícios de montagem.

### MARENGA RD4 52 EMBUTIDA

230 V LED 6 W 3000 K 570 lm Ra 80

R14007 branco/Eco PLA

€ 78 **NEW**

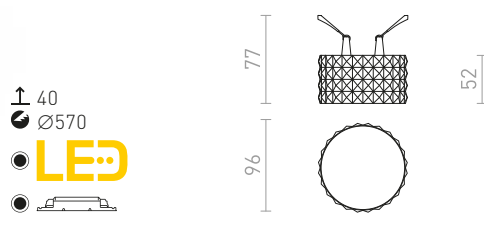

### MARENGA RD3 60 EMBUTIDA

230 V LED 6 W 3000 K 570 lm Ra 80

R14008 branco/Eco PLA

€ 78 **NEW**

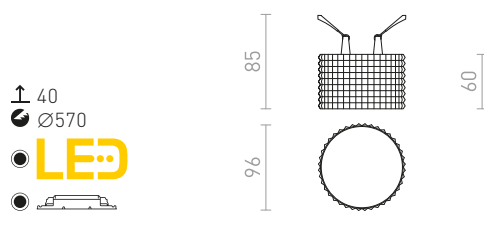

### MARENGA RD1 73 EMBUTIDA

230 V LED 6 W 3000 K 570 lm Ra 80

R14009 branco/Eco PLA

€ 78 **NEW**

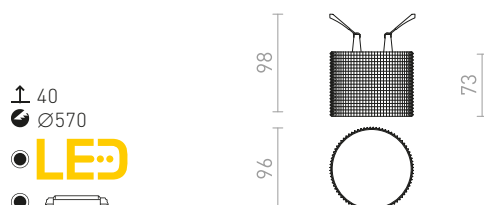

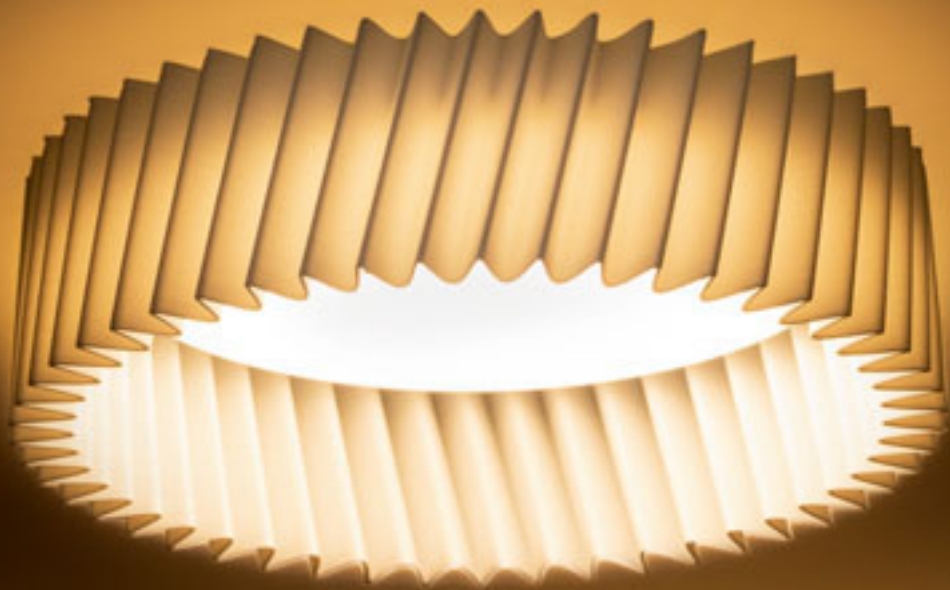



## MARENGA

Candeiro LED de encastrar para teto em pladur com uma profundidade de encastramento reduzida e um abajur decorativo. O abajur é criado por impressão 3D. Feito de material PLA ecológico, que é totalmente degradável. O tamanho do furo de montagem pode ser ajustado usando as molas de fixação deslizantes. A lâmpada pode substituir convenientemente as lâmpadas halógenas existentes sem a necessidade de modificar os orifícios de montagem.

### MARENGA RW1 30 EMBUTIDA

230 V LED 6 W 3000 K 570 lm Ra 80

R14013 branco/Eco PLA

€ 68 **NEW**

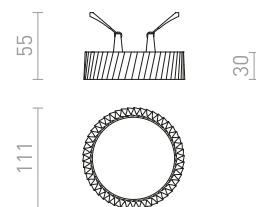
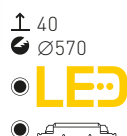

### MARENGA RT1 40 EMBUTIDA

230 V LED 6 W 3000 K 570 lm Ra 80

R14012 branco/Eco PLA

€ 68 **NEW**

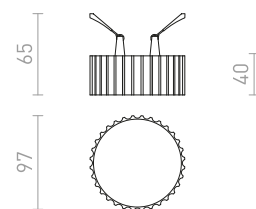
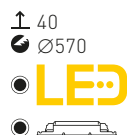

### MARENGA RL1 40 EMBUTIDA

230 V LED 6 W 3000 K 570 lm Ra 80

R14005 branco/Eco PLA

€ 68 **NEW**

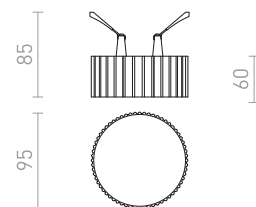
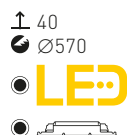

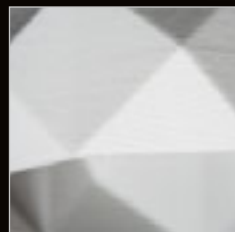



## MARENGA

Candeeiro LED de encastrar para teto em pladur com uma profundidade de encastramento reduzida e um abajur decorativo. O abajur é criado por impressão 3D. Feito de material PLA ecológico, que é totalmente degradável. O tamanho do furo de montagem pode ser ajustado usando as molas de fixação deslizantes. A lâmpada pode substituir convenientemente as lâmpadas halógenas existentes sem a necessidade de modificar os orifícios de montagem.

### MARENGA RD5 28 EMBUTIDA

230 V LED 6 W 3000 K 570 lm Ra 80

R14006 branco/Eco PLA

€ 58

NEW

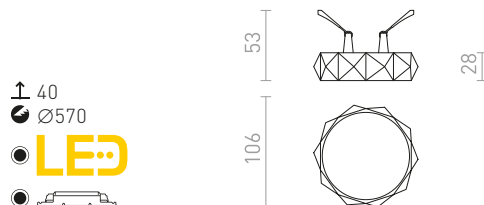

### MARENGA RD6 96 EMBUTIDA

230 V LED 6 W 3000 K 570 lm Ra 80

R14010 branco/Eco PLA

€ 78

NEW

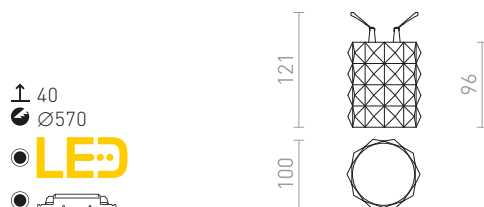

### MARENGA RC1 98 EMBUTIDA

230 V LED 6 W 3000 K 570 lm Ra 80

R14015 branco/Eco PLA

€ 78

NEW

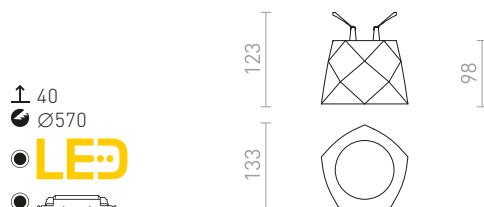

### MARENGA RW2 60 EMBUTIDA

230 V LED 6 W 3000 K 570 lm Ra 80

R14014 branco/Eco PLA

€ 78

NEW

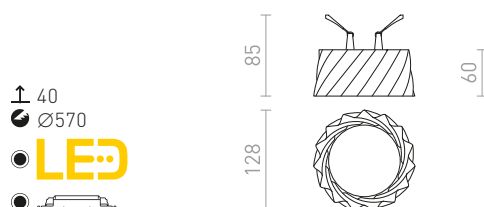





## BIANCA

Luminária embutida em vidro acetinado ou opalino.

### BIANCA SQ EMBUTIDA

230 V GU10 50 W

R10304 vidro colorido opala

€ 28 %

↑ 100  
● Ø62



G11841

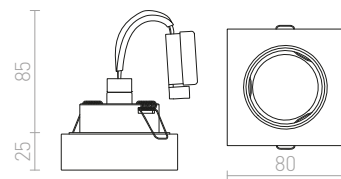

## KAY

Luminária embutida com cobertura de vidro acetinado.

### KAY R EMBUTIDA

230 V/350 mA LED 5 W 3000 K 450 lm Ra 80

R10419 vidro acetinado

€ 22 %

↑ 80  
● Ø65

● LED

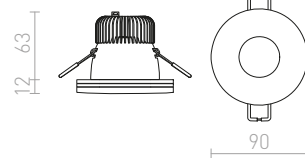

### KAY SQ EMBUTIDA

230 V/350 mA LED 5 W 3000 K 450 lm Ra 80

R10418 vidro acetinado

€ 22 %

↑ 80  
● Ø65

● LED

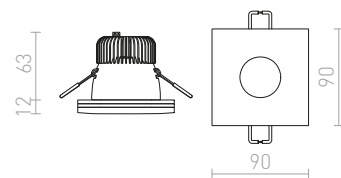





## QUO

Luminária de gesso redonda sem moldura. A superfície pode ser pintada com tinta para interiores. Instalação apenas em paredes de gesso.

### QUO R II EMBUTIDA

230 V GU10 2x35 W

R12900 gesso

€ 48

↑ 160  
↙ 80x150



G11841

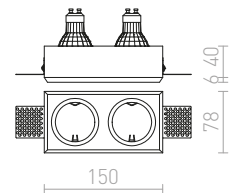

### QUO R EMBUTIDA

230 V GU10 35 W

R12361 gesso

€ 22

↑ 150  
↙ 80x80



G11841

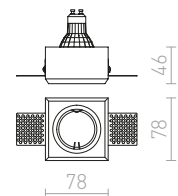

## DAG

Luminária embutida em gesso sem moldura. Instalação apenas em paredes de gesso.

### DAG R 83 EMBUTIDA

230 V GU10 35 W

R12357 gesso

€ 28

↑ 150  
● Ø130



G11841

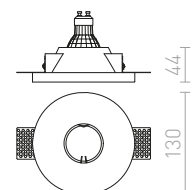



## DANDY

Luminária de gesso embutida sem moldura para fontes de luz com casquilho GU10. Instalação apenas em paredes de gesso.

### DANDY R EMBUTIDA

230 V GU10 35 W

R12362 gesso

€ 18.50



↑ 150  
 ● Ø100

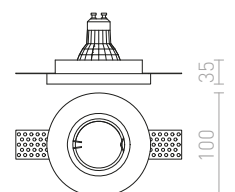



## DAG

Luminária embutida em gesso sem moldura.  
Instalação apenas em paredes de gesso.

### DAG SQ EMBUTIDA

230 V GU10 35 W

R12355 gesso

€ 24

↑ 150  
120x120



G11841

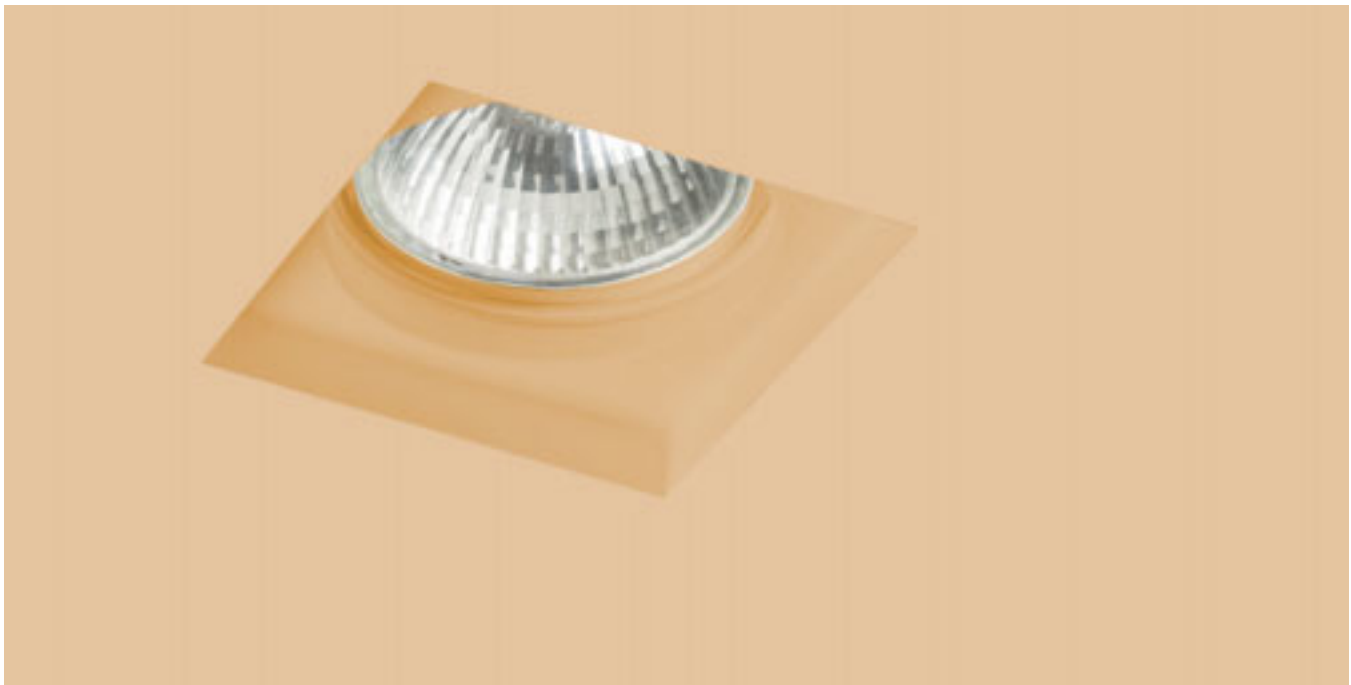
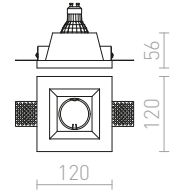

## DANDY

Luminária de gesso embutida sem moldura para fontes de luz com casquilho GU10. Instalação apenas em paredes de gesso.

### DANDY SQ EMBUTIDA

230 V GU10 35 W

R12363 gesso

€ 18.50

↑ 150  
100x100



G11841

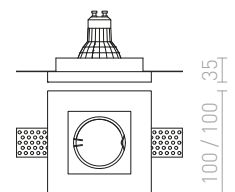



## QUO

Luminária de gesso quadrada sem moldura.  
A superfície pode ser pintada com tintas para interiores. Instalação apenas em paredes de gesso.

### QUO SQ I EMBUTIDA

230 V GU10 35 W

R12360 gesso

€ 22

↑ 150  
80x80



G11841

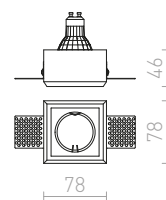

### QUO SQ II EMBUTIDA

230 V GU10 2x35 W

R13126 gesso

€ 48

↑ 160  
80x150



G11841

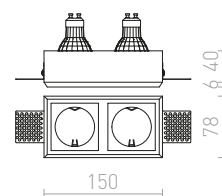





## DINGO

Luminária embutida em gesso, sem moldura. Pode ser pintada com tintas para interiores. Instalação apenas em paredes de gesso.

**DINGO S FIXO**  
230 V GU10 35 W

**R12358** gesso

€ 24

↑ 150  
120x120



G11841

## DINGO S DIRECIONAL

12 V GU5,3 50 W

**R10271** gesso

€ 68

↑ 150  
Ø157



G13705

G13002

## DINGO GU10 II DIRECIONAL

230 V GU10 2x35 W

**R12037** gesso

€ 120

↑ 150  
257x157



G11841





## DINGO

Luminária de gesso embutida sem moldura e com abertura redonda. Pode ser pintada com tintas comuns. Apenas para instalação em paredes de gesso.

### DINGO R DIRECIONAL

12V G53 50W

R10269 gesso

€ 120

↑ 150

● Ø232



G13656

G13002

96

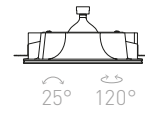

25° 120°

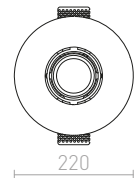

220



## DINGO

Luminária de gesso embutida com abertura oval para duas fontes de luz. Sem moldura. Pode ser pintada com tintas para interiores. Apenas para instalação em paredes de gesso.

### DINGO II DIRECIONAL

12V G53 2x50W

R10270 gesso

€ 138

↑ 150

■ 408x250



G13656

G13002

110

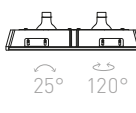

25° 120°

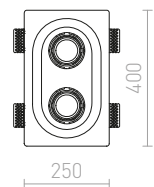

250









## DINO SQUARE

Luminária embutida sem moldura, em gesso, com abertura quadrada. A superfície pode ser pintada com tintas para interiores. Instalação apenas em paredes de gesso.

### DINO SQ G53 DIRECIONAL

12 V G53 50 W

R10272 gesso

€ 68 %

↑ 150

⚡ 252x252



G13656



G13002

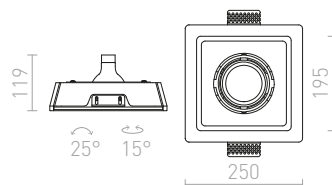

### DINO SQ GU10 DIRECIONAL

230 V GU10 35 W

R12038 gesso

€ 78

↑ 150

⚡ 157x157



G11841

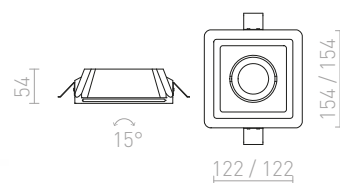

## DAN SQ

Luminária de gesso embutida com cobertura de vidro acetinado. Instalação apenas em tetos de gesso.

### DAN SQ 80 EMBUTIDA

230 V GU10 35 W

R12356 gesso

€ 25

↑ 150

⚡ 120x120



G11841

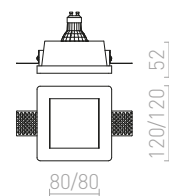



## DINGO

Luminária de gesso embutida com foco inclinável, para fontes de luz G5.3. Instalação apenas em paredes de gesso.

### DINGO TUB EMBUTIDA

12 V GU5,3 35 W

R12359 gesso

€ 68



↑ 150  
 170x170



G13705



G13002

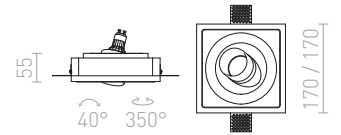

## MIA

Luminária de gesso embutida com cobertura de policarbonato mate. Sem moldura. Instalação apenas em tetos de gesso cartonado.

### MIA R EMBUTIDA

230 V E27 2x18 W

R10444 gesso/acrílico acetinado

€ 158



↑ 180  
 Ø260



G13155

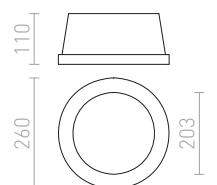



## COIMBRA

Luminária circular de encastrar com LED integrado e regulação de profundidade ajustável. Apenas para instalação em paredes de gesso cartonado.

### COIMBRA EMBUTIDA

230 V LED 24 W 3000 K 1800 lm Ra 80

R12527 preto

€ 88 %

↑ 150  
● Ø450

● LED

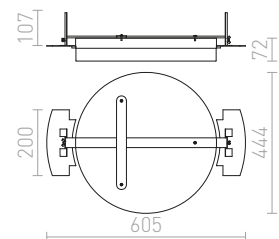



## IPSO

Luz embutida sem moldura para fontes de luz com casquilho GU10.

### IPSO R FIXO

230 V GU10 35 W

R13288 branco

€ 24

↑ 150

⊙ Ø85



G11841

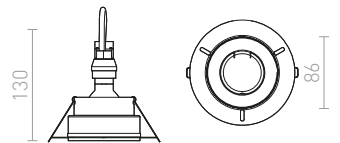

### IPSO R FRAMELESS

230 V GU10 50 W

R12046 branco

€ 48

↑ 140

⊙ Ø120



G11841

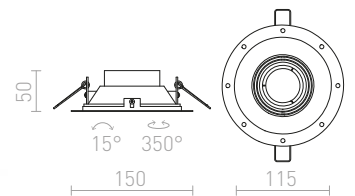

### IPSO SQ FRAMELESS

230 V GU10 50 W

R12045 branco

€ 48

↑ 140

⊙ 120x120



G11841

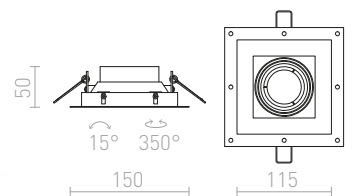



## ELECTRA

Luminária embutida sem moldura com casquilho cardan para fontes de luz GU10.

### ELECTRA I

230 V GU10 50 W

R12052 preto

€ 78

↑ 140  
 108x108



G11841

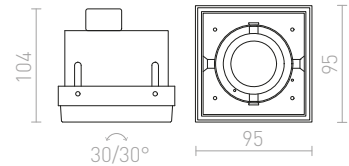

### ELECTRA II

230 V GU10 2x50 W

R12053 preto

€ 129

↑ 140  
 213x108



G11841

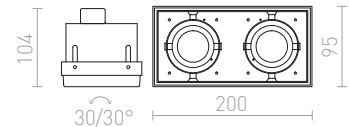



## ELECTRA

Luminária embutida sem moldura com casquilho cardan para fontes de luz 12V G53. O transformador é vendido separadamente.

**ELECTRA I**  
12 V G53 50 W

**R12050** preto

€ 120 ➤



↑ 180  
▣ 170x170



G13656



G13002

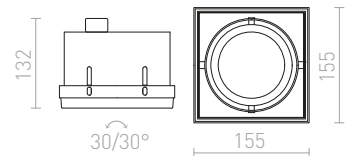



## KELLY LED

Luz embutida com uma fonte de luz LED fixa integrada. Somente para instalação em parede de gesso cartonado. Regulação da intensidade da luz TRIAC.

### KELLY LED DIMM EMBUTIDA

230 V LED 15 W  $\angle 45^\circ$  3000 K 750 lm Ra 80

R12635 branco

€ 98

R12636 preto

€ 98

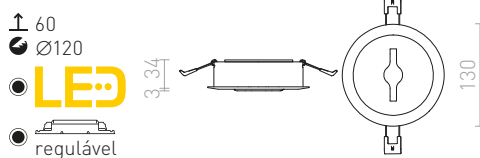

## ZIZI

Luminária embutida em alumínio lacado de branco, inclinável, para fontes de luz AR111.

### ZIZI I EMBUTIDA

12 V G53 50 W

R12695 branco

€ 35 %

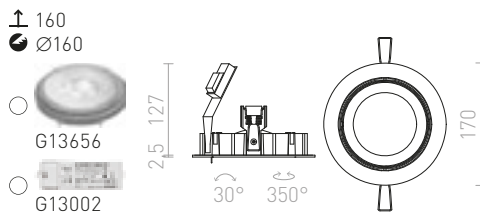

### ZIZI II EMBUTIDA

12 V G53 50 W

R12696 branco

€ 68 %

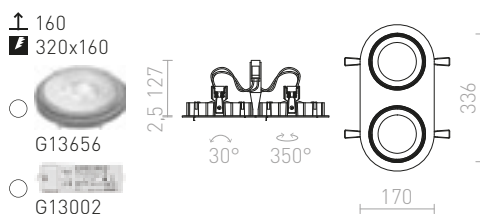



## KELLY LED

Luz regulável semi-embutida com LED integrado e um foco direcional. Somente para instalação em teto de gesso cartonado. Regulação da intensidade da luz TRIAC.

### KELLY LED DIMM SEMI EMBUTIDA

230 V LED 12 W  $\angle 24^\circ$  3000 K 600 lm Ra 80

**R12637** branco

€ 98

**R12638** preto

€ 98

↑ 50

● Ø65

● LED

● regulável

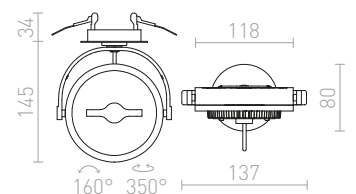





## GRANADA

Foco embutido em alumínio lacado maciço com inclinação, para fontes de luz AR111.

### GRANADA SQ

12V G53 50W

R12707 branco

€ 32 %

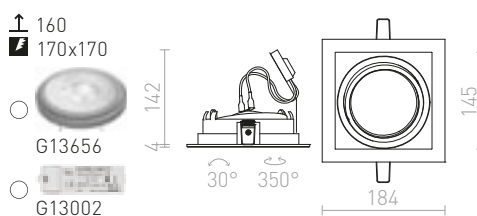

## SPRAY

Luminária embutida com uma fonte de luz LED fixa, apenas para instalação em paredes de gesso.

### SPRAY 11 EMBUTIDA

230 V LED 9 W  $\angle 24^\circ$  3000 K 1250 lm Ra 90

R13302 preto

€ 18.50 %

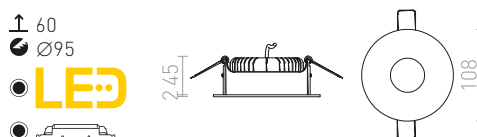

### SPRAY 9 EMBUTIDA

230 V LED 7 W  $\angle 24^\circ$  3000 K 880 lm Ra 90

R13300 preto

€ 14 %

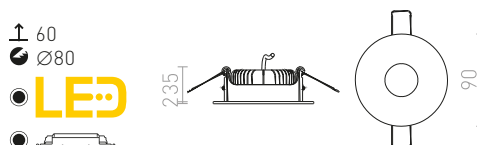





## PASADENA

Luminária de alumínio embutida inclinável. Disponível em versão natural ou duas versões lacadas. Para fontes de luz GU10.

### PASADENA GU10 SQ I EMBUTIDA

230 V GU10 50 W

**R12709** alumínio escovado € 22

**R12710** branco € 22

**R12711** preto € 22

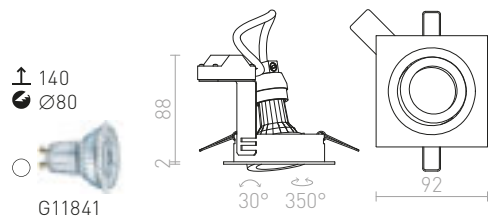

### PASADENA GU10 SQ II EMBUTIDA

230 V GU10 2x50 W

**R12712** alumínio escovado € 29

**R12713** branco € 48

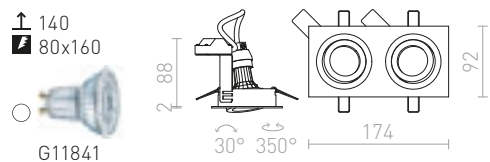



## PASADENA

Luminária de alumínio embutida inclinável.  
Disponível em versão natural ou duas versões lacadas.  
Para fontes de luz AR111.

### PASADENA G53 R I

12 V G53 50 W

R12697 branco

€ 58

R12699 preto

€ 58

↑ 140

⊙ Ø145



G13656

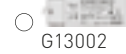

G13002

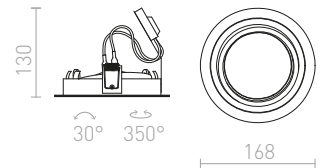

## PASADENA

Luminária embutida para fontes de luz AR111 com opção de inclinação.

### PASADENA G53 SQ I

12 V G53 50 W

R12700 branco

€ 58

R12702 preto

€ 48

↑ 150

⊙ Ø150



G13656



G13002

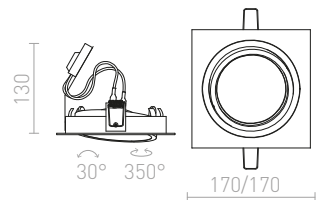

### PASADENA G53 SQ II

12 V G53 2x50 W

R12703 branco

€ 120

R12704 alumínio escovado

€ 120

R12705 preto

€ 88

↑ 150

⊞ 315x150



G13656



G13002

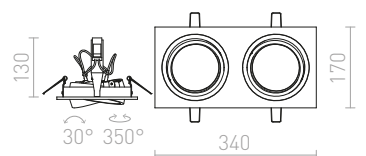



## LIZARD

Luminária pequena embutida com LED integrado, apenas para tetos em gesso.

### LIZARD I EMBUTIDA

230 V LED 2 W  $\angle 24^\circ$  3000 K 128 lm Ra 80

R12854 branco

€ 12 %

↑ 150  
 ▣ 35x35

● LED

● regulamento opcional

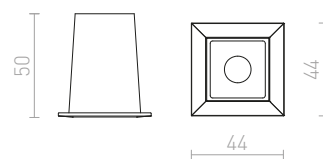

## BONDY

Luminária embutida de LED para tetos de gesso.

### BONDY I EMBUTIDA

230 V LED 7 W  $\angle 24^\circ$  3000 K 560 lm Ra 80

R12856 branco

€ 68

↑ 100  
 ▣ 90x90

● LED

● regulamento opcional

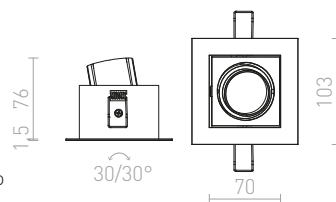

### BONDY II EMBUTIDA

230 V LED 2x7 W  $\angle 24^\circ$  3000 K 1120 lm Ra 80

R12857 branco

€ 88

↑ 100  
 ▣ 170x90

● LED

● regulamento opcional

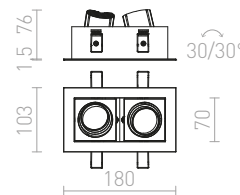

### BONDY III EMBUTIDA

230 V LED 3x7 W  $\angle 24^\circ$  3000 K 1680 lm Ra 80

R12858 branco

€ 88 %

↑ 100  
 ▣ 243x90

● LED

● regulamento opcional

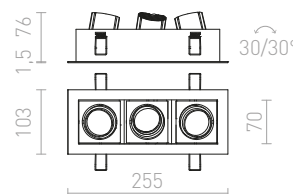





## FIZZ

Luminária embutida com moldura de alumínio e casquilhos cardan, para fontes de luz inclináveis em todas as direções. Apenas para paredes de gesso.

### FIZZ III DIRECIONAL

12V GU5,3 3x50W

R10148 alumínio

€ 58 %

↑ 95

■ 241x88



G13705



G13002

45/30°

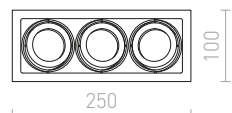

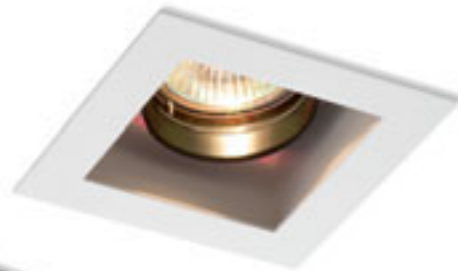

## MONE

Luminária com foco inclinável num eixo. Moldura de alumínio lacado. Apenas para paredes de gesso.

### MONE I DIRECIONAL

12 V GU5,3 50 W

R10204 branco

€ 22 %

↑ 140

▣ 83x85



G13705



G13002

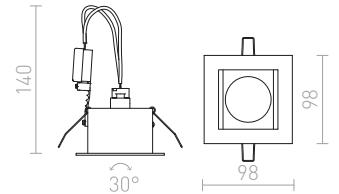

### MONE II DIRECIONAL

12 V GU5,3 2x50 W

R10217 cinzento prata

€ 29 %

↑ 140

▣ 145x85



G13705

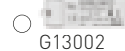

G13002

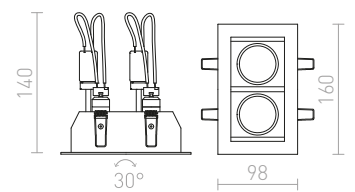

### MONE III DIRECIONAL

12 V GU5,3 3x50 W

R10218 cinzento prata

€ 32 %

↑ 140

▣ 215x85



G13705



G13002

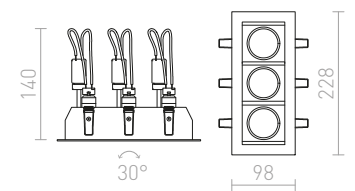





## VIP

Foco giratório de metal em design circular.

### VIP DOBRAR

230 V GU10 50 W

R11746 mate branco

€ 16.50

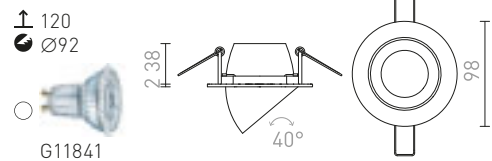

## SOBER

Foco circular ligeiramente inclinável de metal lacado branco, com lâmpada embutida.

### SOBER EMBUTIDA

230 V GU10 50 W

R11738 branco

€ 24

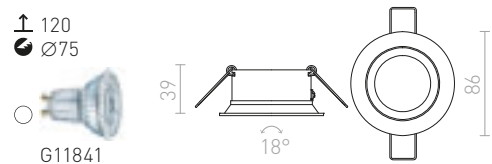



## TOPIC

Foco embutido metálico inclinável em cromo, níquel mate ou acabamento lacado em branco.

### TOPIC R DIRECIONAL

230 V GU10 50 W

**R11731** níquel mate

€ 6 %

**R11742** cromo

€ 5.80 %

**R11743** mate branco

€ 10.50

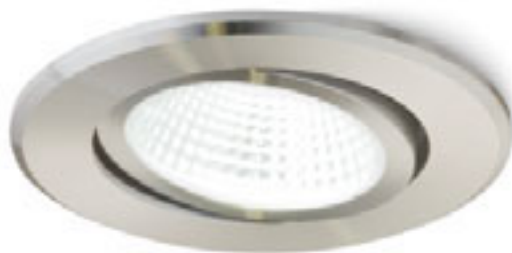
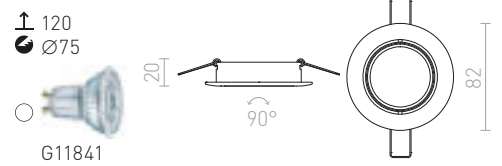

## MIRO

Foco embutido inclinável com LED integrado. Driver incluído.

### MIRO EMBUTIDA

230 V/350 mA LED 3 W 3000 K 270 lm Ra 80

**R10420** aço inoxidável

€ 19.50 %

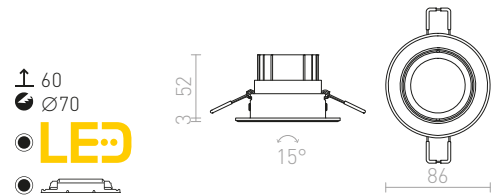

## REWA

Luminária embutida com moldura maciça texturada.

### REWA FIXA

230 V GU10 50 W

**R10421** cromo

€ 19 ➔

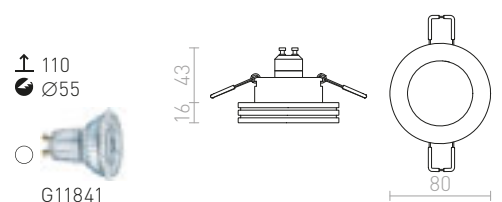





## TECH I

Foco embutido fixo com LED integrado, revestido com vidro transparente.

### TECH I FIXA

230 V LED 5,4 W  $\angle 40^\circ$  3000 K 340 lm Ra 80

R10404 branco

€ 25

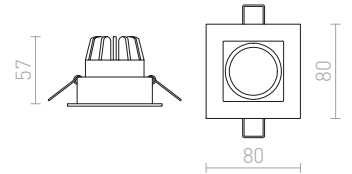
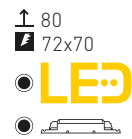

## LEDA

Foco embutido com montagem em cardan de fonte de luz LED.

### LEDA EMBUTIDA

230 V/350 mA LED 5,4 W  $\angle 25^\circ$  3000 K 340 lm Ra 80

R10402 branco

€ 48

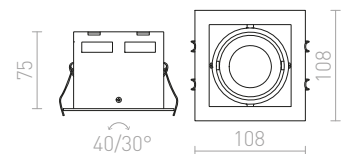
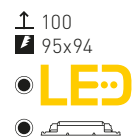

## TIM

Foco embutido inclinável com LED integrado. Driver incluído.

### TIM EMBUTIDA

230 V LED 10 W 3000 K 750 lm Ra 80

R12009 branco

€ 58

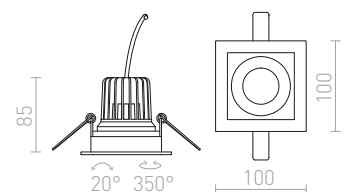
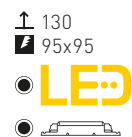



## TOPIC

Foco embutido metálico inclinável em cromo, níquel mate ou acabamento lacado em branco.

### TOPIC SQ DIRECIONAL

230 V GU10 50 W

**R11732** níquel mate

€ 5.35 %

**R11744** cromo

€ 5.35 %

**R11745** mate branco

€ 9.20

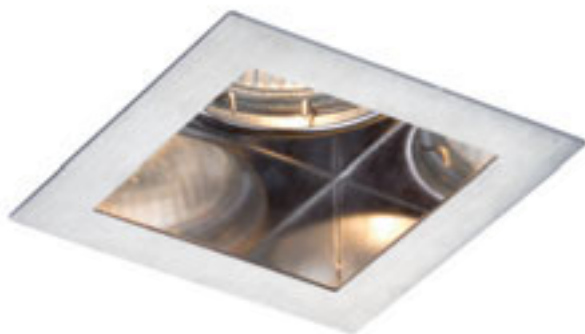
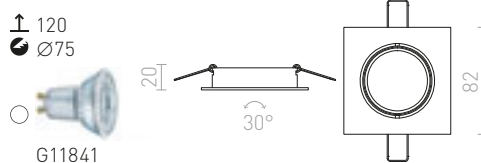

## MERIKO

Foco redondo embutido inclinável para uma fonte de luz GU10. Apenas para uso em paredes de gesso.

### MERIKO GU10 FIXO

230 V GU10 50 W

**R10219** aço inoxidável

€ 18.50 %

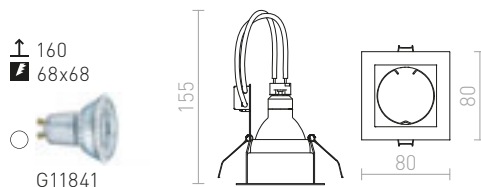

## ZURI

Foco embutido quadrado com um casquilho fixo GU10.

### ZURI SQ EMBUTIDA

230 V GU10 35 W

**R13391** preto

€ 10.50 %

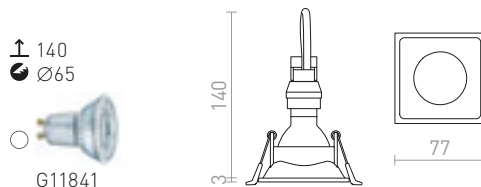



## MURO

Foco quadrado embutido angular com inclinação para fontes de luz GU10. Apenas para paredes em gesso.

### MURO SQ EMBUTIDA

230 V GU10 50 W

R12748 níquel mate

€ 9.20

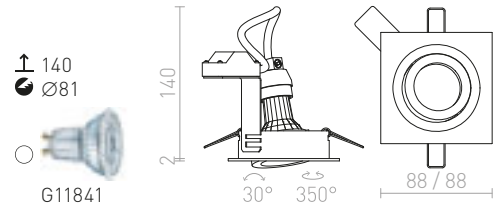

## ACASA

Foco redondo embutido inclinável para casquilho GU10. Apenas para uso em paredes de gesso.

### ACASA EMBUTIDA

230 V GU10 50 W

R12750 branco

€ 24

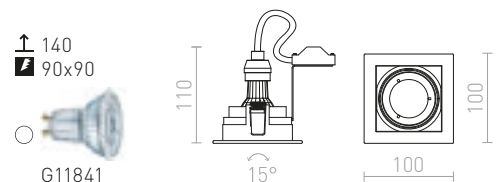

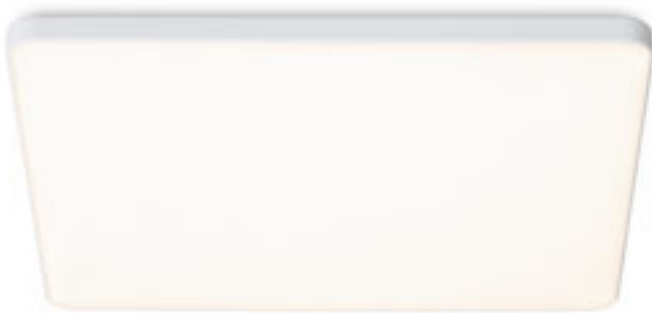

## BJORK

Iluminação LED embutida para instalação em tetos com pouca profundidade. A estrutura e o design deste produto são muito semelhantes aos da gama LARISA e, por isso, é uma combinação adequada. Devido ao facto de as molas de instalação serem ajustáveis, o candeeiro pode ser instalado em furos de teto pré-existentes, o que o torna uma excelente escolha para substituir antigos candeeiros de halogéneo.

### BJORK SQ 9 EMBUTIDA

230 V LED 6 W 3000 K 640 lm Ra 80

**R13588** branco

€ 26

**R13589** preto

€ 26

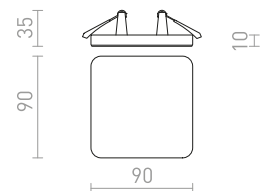

### BJORK SQ 20 EMBUTIDA

230 V LED 18 W 3000 K 1800 lm Ra 80

**R13590** branco

€ 58

**R13591** preto

€ 58

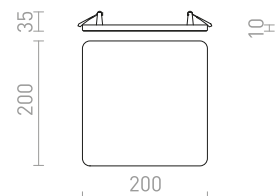
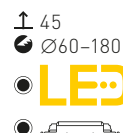



## BJORK

Iluminação LED embutida para instalação em tetos com pouca profundidade. A estrutura e o design deste produto são muito semelhantes aos da gama LARISA e, por isso, é uma combinação adequada. Devido ao facto de as molas de instalação serem ajustáveis, o candeeiro pode ser instalado em furos de teto pré-existentes, o que o torna uma excelente escolha para substituir antigos candeeiros de halogéneo.

### BJORK R 9 EMBUTIDA

230 V LED 6 W 3000 K 570 lm Ra 80

R13582 branco

€ 24

R13583 preto

€ 24

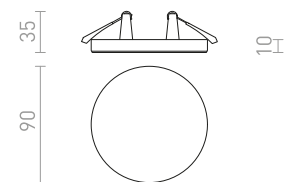

### BJORK R 16 EMBUTIDA

230 V LED 12 W 3000 K 1200 lm Ra 80

R13584 branco

€ 38

R13585 preto

€ 38

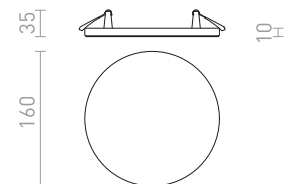
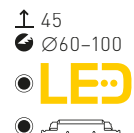

### BJORK R 20 EMBUTIDA

230 V LED 18 W 3000 K 1800 lm Ra 80

R13586 branco

€ 58

R13587 preto

€ 58

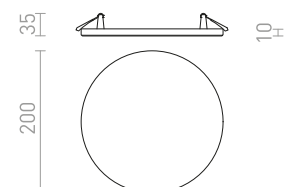





## DADA

Luminária LED circular embutida para tetos em gesso com moldura arredondada e baixa profundidade na reentrância. Apenas para paredes de gesso.

### DADA 9 EMBUTIDA

230 V LED 3 W 3000 K 180 lm Ra 80

R12870 cromo preto

€ 9.35 %

↑ 60  
● Ø75

● LED

● regulamento

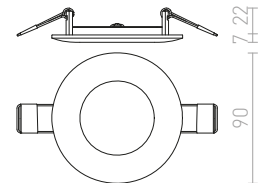

### DADA 12 EMBUTIDA

230 V LED 6 W 3000 K 360 lm Ra 80

R12871 branco

€ 13.50 %

R12872 cromo

€ 15 %

R12875 cromo preto

€ 15 %

↑ 60  
● Ø110

● LED

● regulamento  
opcional

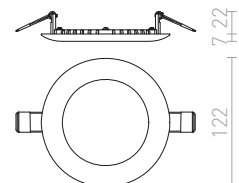



## DADA

Luminária LED circular embutida para tetos em gesso com moldura arredondada e baixa profundidade na reentrância. Apenas para paredes de gesso.

### DADA 17 EMBUTIDA

230 V LED 12 W 3000 K 720 lm Ra 80

R12876 branco	€ 19	%
R12877 cromo	€ 22	%
R12880 cromo preto	€ 15.50	%

- ↑ 60
- ⊗ Ø160
- LED
- regulamento opcional

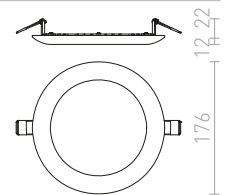

### DADA 23 EMBUTIDA

230 V LED 18 W 3000 K 1080 lm Ra 80

R12881 branco	€ 26	%
R12882 cromo	€ 13.50	%
R12884 cobre	€ 24	%
R12885 cromo preto	€ 28	%

- ↑ 100
- ⊗ Ø210
- LED
- regulamento opcional

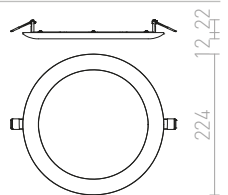

### DADA 30 EMBUTIDA

230 V LED 24 W 3000 K 1440 lm Ra 80

R12886 branco	€ 38	%
R12887 cromo	€ 26	%
R12888 ouro	€ 32	%
R12889 cobre	€ 32	%
R12890 cromo preto	€ 26	%

- ↑ 100
- ⊗ Ø280
- LED
- regulamento opcional

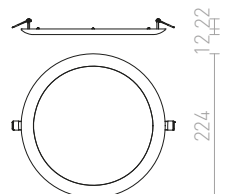



## HUE

Luminária muito fina embutida, para LEDs de alta luminosidade. A moldura está disponível em cromo, cromo preto, níquel mate, laca branca e imitação de madeira.

### HUE R 9 EMBUTIDA

230 V LED 6 W 3000 K 540 lm Ra 80

<b>R12760</b> branco	€ 22	→
<b>R12761</b> cromo preto	€ 15.50	%
<b>R12763</b> níquel mate	€ 15.50	%
<b>R12764</b> faixa decorativa	€ 22	→

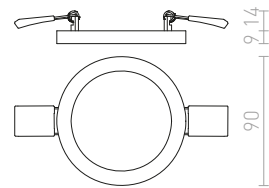
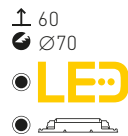

### HUE R 17 EMBUTIDA

230 V LED 18 W 3000 K 1620 lm Ra 80

<b>R12765</b> branco	€ 48	→
<b>R12766</b> cromo preto	€ 24	%
<b>R12767</b> cromo	€ 48	%
<b>R12768</b> níquel mate	€ 35	%
<b>R13401</b> imitação de imbuia escura	€ 35	%

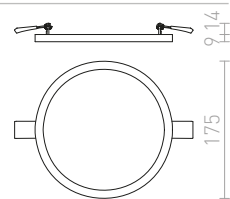
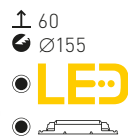

### HUE R 22 EMBUTIDA

230 V LED 24 W 3000 K 2160 lm Ra 80

<b>R12770</b> branco	€ 68	→
<b>R12771</b> cromo preto	€ 48	%
<b>R12772</b> cromo	€ 48	%
<b>R12773</b> níquel mate	€ 48	%
<b>R12774</b> faixa decorativa	€ 68	→
<b>R13402</b> imitação de imbuia escura	€ 58	%

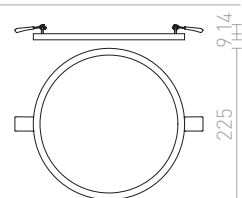
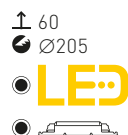







## HUE

Luminária muito fina embutida para LEDs de alta luminosidade. A moldura está disponível em cromo, cromo preto, níquel mate, laca branca e imitação de madeira. Regulação da intensidade da luz TRIAC.

### HUE R 9 DIMM EMBUTIDA

230 V LED 6 W 3000 K 540 lm

<b>R13127</b> branco	€ 58
<b>R13128</b> cromo preto	€ 48
<b>R13130</b> níquel mate	€ 48
<b>R13131</b> faixa decorativa	€ 58

- ↑ 60
- Ø70
- LED
- regulável

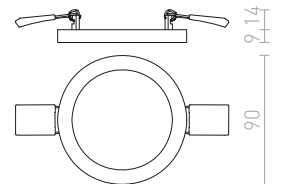

### HUE R 17 DIMM EMBUTIDA

230 V LED 18 W 3000 K 1620 lm Ra 80

<b>R13053</b> branco	€ 120
<b>R13054</b> cromo preto	€ 88
<b>R13055</b> cromo	€ 98
<b>R13056</b> níquel mate	€ 98
<b>R13441</b> imitação de imbuia escura	€ 98

- ↑ 60
- Ø155
- LED
- regulável

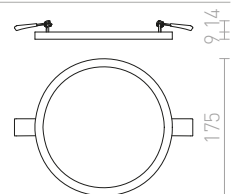

### HUE R 22 DIMM EMBUTIDA

230 V LED 24 W 3000 K 2160 lm Ra 80

<b>R13058</b> branco	€ 129
<b>R13059</b> cromo preto	€ 120
<b>R13060</b> cromo	€ 120
<b>R13061</b> níquel mate	€ 120
<b>R13062</b> faixa decorativa	€ 120
<b>R13442</b> imitação de imbuia escura	€ 120

- ↑ 60
- Ø205
- LED
- regulável

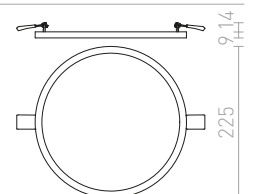

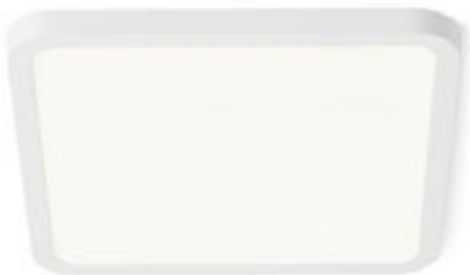

## HUE

Luminária muito fina embutida, para LEDs de alta luminosidade. A moldura está disponível em cromo, cromo preto, níquel mate, laca branca e imitação de madeira.

### HUE SQ 9 EMBUTIDA

230 V LED 6 W 3000 K 540 lm Ra 80

<b>R12775</b> branco	€ 19	→
<b>R12776</b> cromo preto	€ 16	%
<b>R12777</b> cromo	€ 18	%
<b>R12778</b> níquel mate	€ 16	%

± 60  
70x70

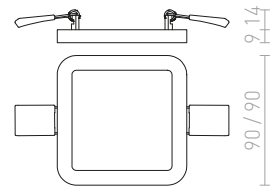
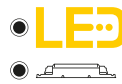

### HUE SQ 17 EMBUTIDA

230 V LED 18 W 3000 K 1620 lm Ra 80

<b>R12780</b> branco	€ 38	%
<b>R12781</b> cromo preto	€ 32	%
<b>R12782</b> cromo	€ 32	%
<b>R12783</b> níquel mate	€ 32	%
<b>R12784</b> faixa decorativa	€ 35	%

± 60  
155x155

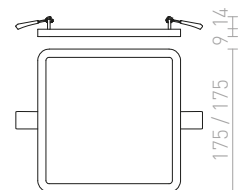

### HUE SQ 22 EMBUTIDA

230 V LED 24 W 3000 K 2160 lm Ra 80

<b>R12785</b> branco	€ 58	%
<b>R12786</b> cromo preto	€ 48	%
<b>R12787</b> cromo	€ 38	%
<b>R12788</b> níquel mate	€ 38	%
<b>R12789</b> faixa decorativa	€ 38	%

± 60  
205x205

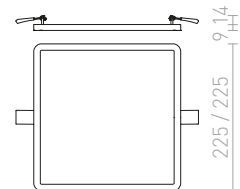







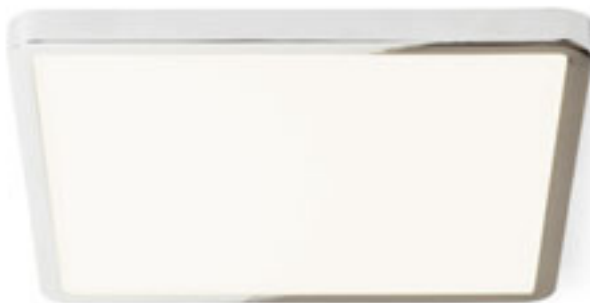

## HUE

Luminária muito fina embutida para LEDs de alta luminosidade. A moldura está disponível em cromo, cromo preto, níquel mate, laca branca e imitação de madeira. Regulação da intensidade da luz TRIAC.

### HUE SQ 9 DIMM EMBUTIDA

230 V LED 6 W 3000 K 540 lm Ra 80

R13132	branco	€ 58
R13133	cromo preto	€ 48
R13134	cromo	€ 58
R13135	níquel mate	€ 58

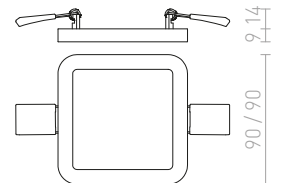
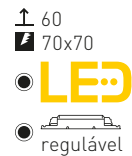

### HUE SQ 17 DIMM EMBUTIDA

230 V LED 18 W 3000 K 1620 lm Ra 80

R13063	branco	€ 120
R13064	cromo preto	€ 98
R13065	cromo	€ 98
R13066	níquel mate	€ 98
R13067	faia decorativa	€ 98

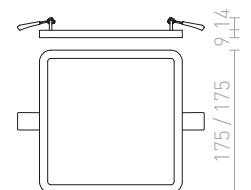
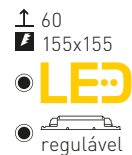

### HUE SQ 22 DIMM EMBUTIDA

230 V LED 24 W 3000 K 2160 lm Ra 80

R13068	branco	€ 120
R13069	cromo preto	€ 120
R13070	cromo	€ 120
R13071	níquel mate	€ 120
R13072	faia decorativa	€ 120

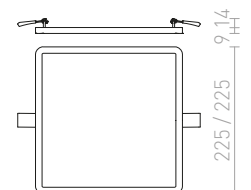
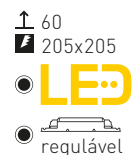



## SLENDER

Luminária embutida muito fina com LED de alta potência integrado. Driver incluído.

### SLENDER SQ 8 EMBUTIDA

230 V LED 3W 3000 K 300 lm Ra 80

**R12186** cromo preto

€ 7.20 %

**R12187** cromo

€ 7.35 %

↑ 50  
 65x65

● LED

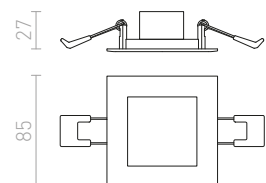



## SOCORRO

Luminária muito fina com LED de alta potência integrado e uma moldura lacada em branco de alumínio fundido. Driver incluído.

### SOCORRO R 85 EMBUTIDA

230 V LED 3 W 3000 K 240 lm Ra 80

R12963 branco

€ 11

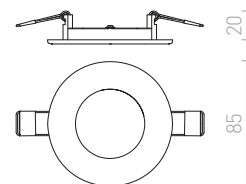
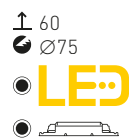

### SOCORRO R 225 EMBUTIDA

230 V LED 18 W 3000 K 1440 lm Ra 80

R12965 branco

€ 32

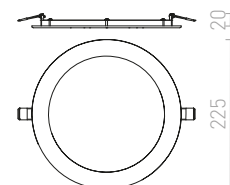

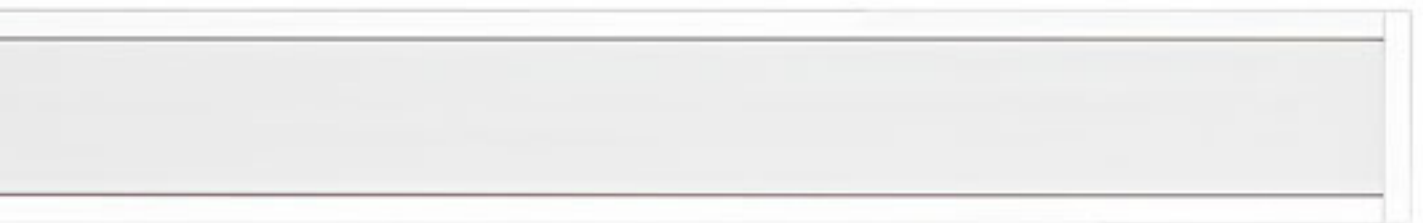

## PESANTE

Luminária de LED linear para tetos de gesso.  
Adequada para interiores modernos.

### PESANTE 90 EMBUTIDA

230 V LED 40 W 3000 K 4200 lm Ra 80

R12722 branco

€ 215

↑ 80

■ 1200x76

● LED

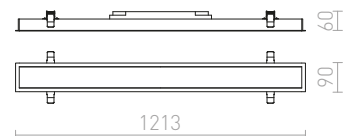



## STRUCTURAL

Luminária embutida com LED e moldura lacada. Inclui o driver.

### STRUCTURAL LED 40x40 EMBUTIDA

230V LED 40W 3000K 2918lm Ra80

R12062 branco

€ 178

↑ 60

■ 395x395

● LED

● regulamento  
opcional

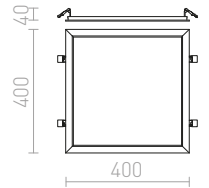



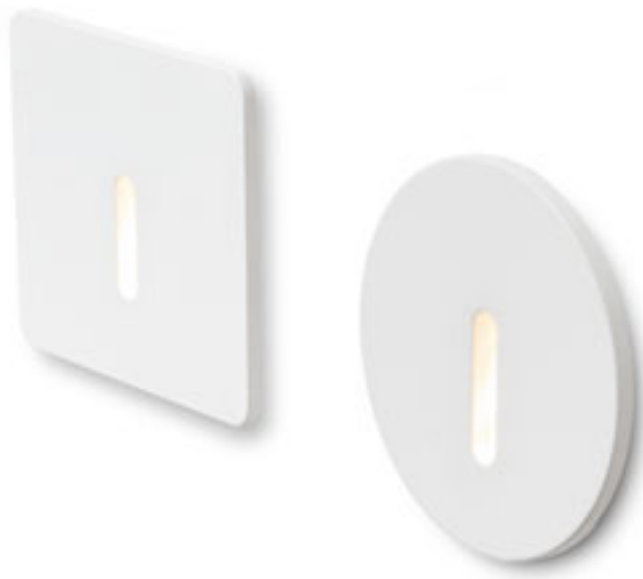

## IRIA

Aplique LED embutido com uma ranhura estreita para o feixe de luz.

### IRIA R EMBUTIDA

230 V LED 3 W  $\angle 10^\circ$  3000 K 390 lm Ra80

R12611 branco

€ 58

↑ 120  
⚡ Ø45



● LED

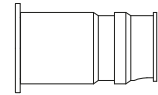

87



55

### IRIA SQ EMBUTIDA

230 V LED 3 W  $\angle 10^\circ$  3000 K 390 lm Ra80

R12612 branco

€ 58

↑ 120  
⚡ Ø45



● LED

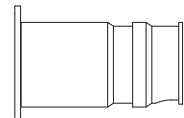

3 84

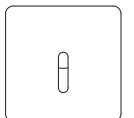

60



IP54

## SEGNO

Aplique LED embutido para exterior com boa radiação emitida através de fenda estreita.

### SEGNO EMBUTIDA

230 V LED 3 W 3000 K Ra80 IP54

R13566 branco

€ 98

R13567 cinzento antracite

€ 98

↑ 70  
⚡ 172x62



● LED

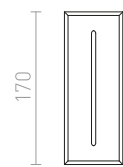

170

65

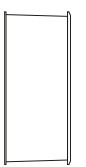

70 3





## MEMPHIS

Aplique LED adequado como luz de orientação para corredores e escadas.

### MEMPHIS R EMBUTIDO NA PAREDE

230 V LED 3 W  $\angle 60^\circ$  3000 K 270 lm Ra 80

R12687 cinzento prata

€ 35

R13956 branco

€ 35

NEW

R13957 preto

€ 35

NEW

$\perp$  90

Ø45



LED

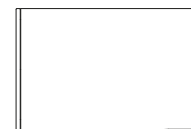

1,5 65

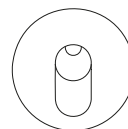

50

### MEMPHIS SQ EMBUTIDO NA PAREDE

230 V LED 3 W  $\angle 60^\circ$  3000 K 270 lm Ra 80

R12688 cinzento prata

€ 38

R13954 branco

€ 38

NEW

R13955 preto

€ 38

NEW

$\perp$  90

Ø40



LED



1,5 65

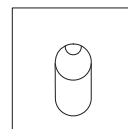

50

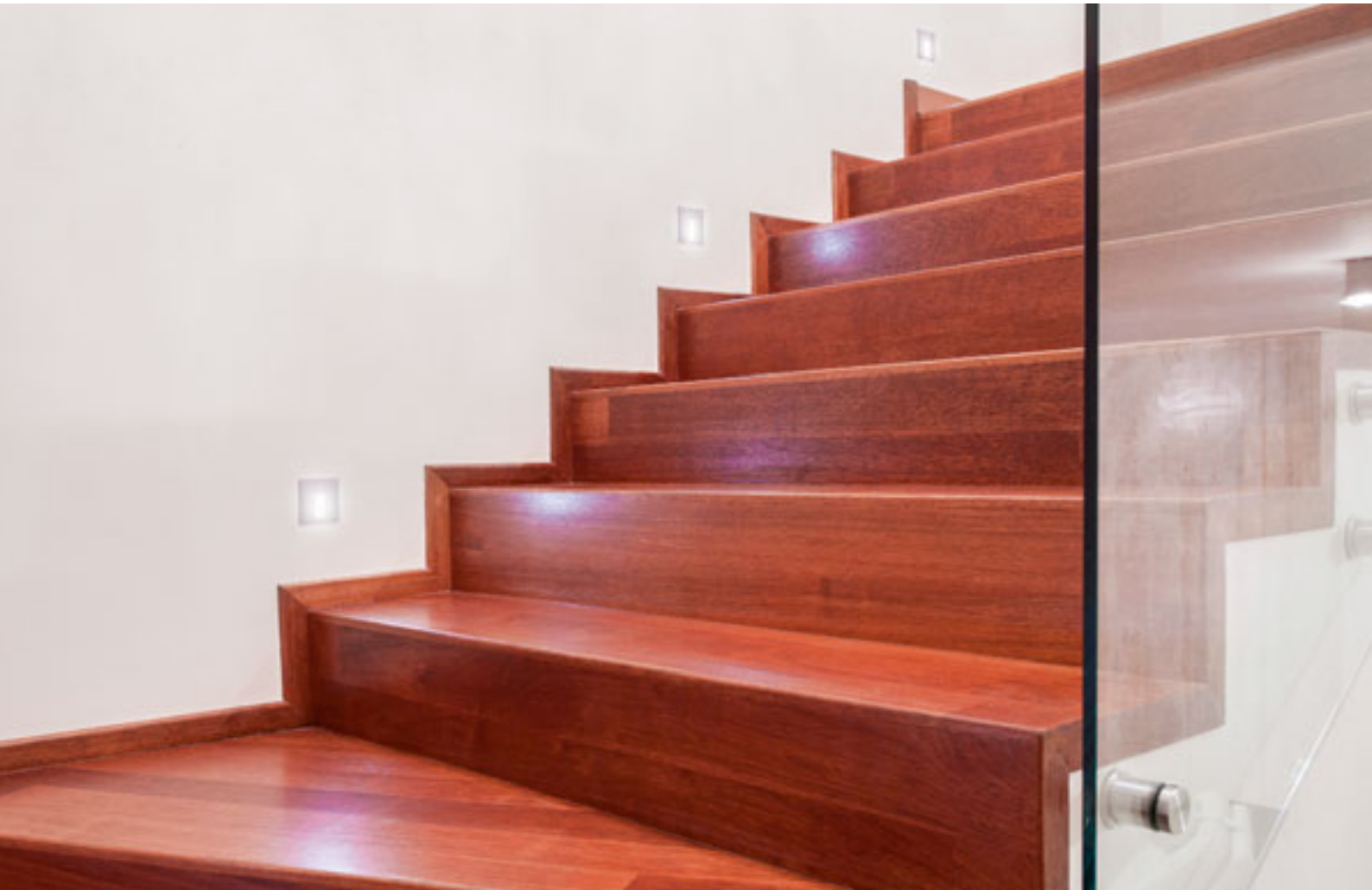

IP54

IP54

## ELICA

Aplique embutido com LED integrado e uma tampa frontal metálica, para utilização no exterior. Apenas para iluminação descendente. Caixa de montagem incluída.

### ELICA R EMBUTIDA

230 V LED 3 W 3000 K 75 lm Ra 80 IP54

R12528 alumínio escovado

€ 58 %

± 95  
Ø 75



LED

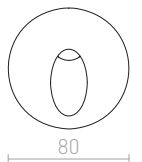
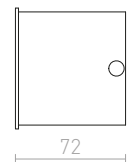

### ELICA SQ EXTERIOR

230 V LED 3 W 3000 K 180 lm Ra 80 IP54

R10639 níquel mate

€ 35 %

R12529 alumínio escovado

€ 58 %

± 70  
Ø 75



LED

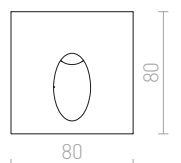
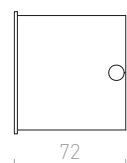





## RIO

Luminária embutida de LED para instalação em paredes ocas ou nichos.

### RIO R EMBUTIDA

230 V LED 3 W  $\angle 22^\circ$  3000 K 70 lm Ra 80

R12656 branco

€ 22

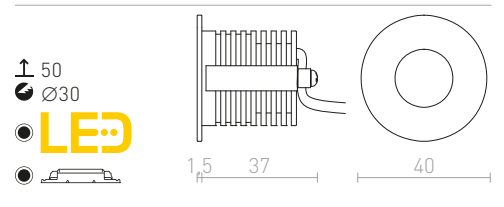

### RIO SQ EMBUTIDA

230 V LED 3 W  $\angle 22^\circ$  3000 K 70 lm Ra 80

R12350 branco

€ 19.50

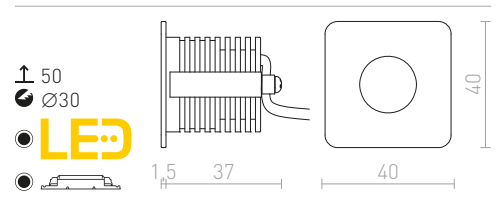

### RIO SQ O EMBUTIDA

230 V LED 3 W  $\angle 22^\circ$  3000 K 70 lm Ra 80

R12655 branco

€ 19.50

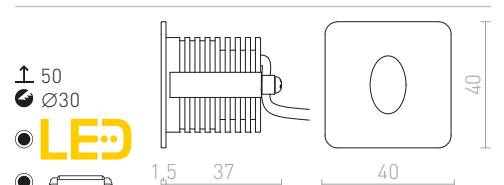



IP54



## MARCO LED

Aplique redondo embutido, adequado para uso interior e exterior. Instale somente para iluminação descendente. Caixa de montagem incluída.

### MARCO EMBUTIDA

230 V LED 3 W 3000 K 80 lm Ra 80 IP54

**R12024** branco € 48

**R12029** cinzento prata € 48

**R12030** cinzento antracite € 48

↑ 60  
● Ø76



● LED

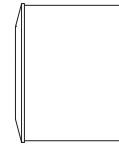

56

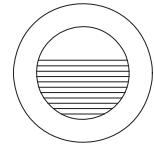

78



IP54

IP54



## CLUB

Aplique LED adequado como luz de orientação para corredores e escadas.

### CLUB EMBUTIDA

230 V LED 3 W 3000 K 270 lm Ra 80 IP54

**R12685** cinzento prata € 48

↑ 90  
● Ø57

● LED

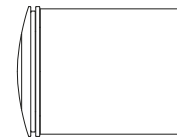

10

65

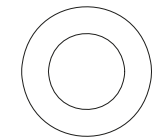

58

### CLUB IND EMBUTIDA

230 V LED 3 W 3000 K 270 lm Ra 80 IP54

**R12686** cinzento prata € 48

↑ 90  
● Ø56



● LED

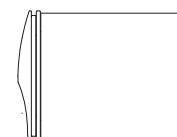

10

65

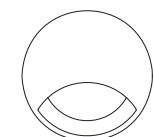

58



IP54



## ASTERIA

Aplique embutido para uso externo. O quadro visível tem uma profundidade de 3 cm. Instale apenas para iluminação descendente.

### ASTERIA EMBUTIDA

230 V LED 3 W 3000 K 180 lm Ra 80 IP54

R10558 cinzento prata

€ 58 %

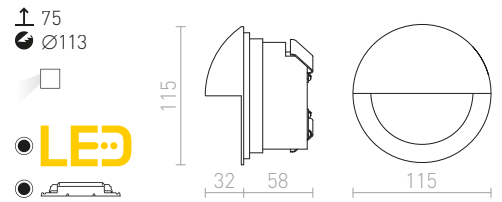





IP54



IP54



IP54

## KICK

Luminária de orientação embutida com LED integrado que emite luz para um, dois ou três lados. Destina-se a instalações de parede.

### KICK I EMBUTIDA

230 V LED 3 W 3000 K 100 lm Ra 80 IP54

R12613 branco

€ 48

R12615 preto

€ 48

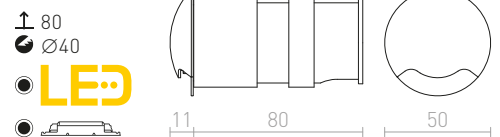

### KICK II EMBUTIDA

230 V LED 3 W 3000 K 120 lm Ra 80 IP54

R12616 branco

€ 48

R12618 preto

€ 48

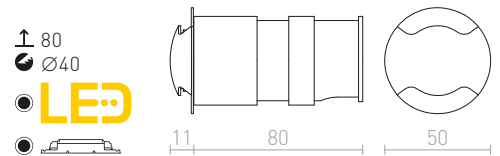

### KICK III EMBUTIDA

230 V LED 3 W 3000 K 150 lm Ra 80 IP54

R12619 branco

€ 48

R12621 preto

€ 48

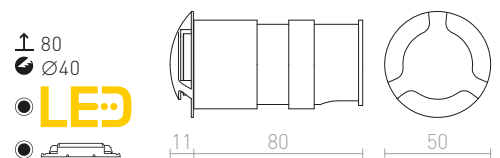





## AMARO

Aplique LED adequado como luz de orientação para corredores e escadas.

### AMARO EMBUTIDA

230 V LED 3 W  $\angle 60^\circ$  3000 K 270 lm Ra 80

R12690 branco

€ 38

R13958 preto

€ 38

NEW



± 70

Ø40



LED

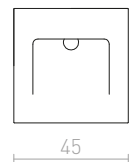
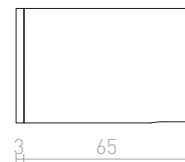



IP54

### PER

Aplique LED adequado para uso interior e exterior como luz de orientação para corredores e escadas.

#### PER EMBUTIDA

230 V LED 3 W 3000 K 76 lm Ra 80 IP54

R12576 branco

€ 58

R12577 cinzento antracite

€ 58



↑ 60

▣ 65x102



LED

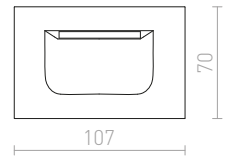

IP54

### TESS

Aplique quadrado embutido adequado para uso interior e exterior. Instale apenas para iluminação descendente. Disponível em três cores diferentes. Caixa de montagem incluída.

#### TESS SQ EMBUTIDA

230 V LED 3 W 3000 K 80 lm Ra 80 IP54

R12013 branco

€ 58

R12014 cinzento prata

€ 58

R12015 cinzento antracite

€ 58



↑ 70

▣ 60x55



LED

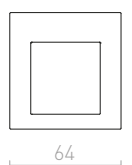
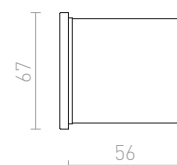



## RAGG

Iluminação de embutir para exterior com luz direcional para iluminar calçadas e escadas.

### RAGG EMBUTIDA

230 V LED 12 W 3000 K 406 lm Ra 80 IP65

R13620 branco

€ 120

R13621 preto

€ 120

↑ 80

↙ 80x230



LED

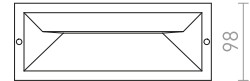

5 85

250

98

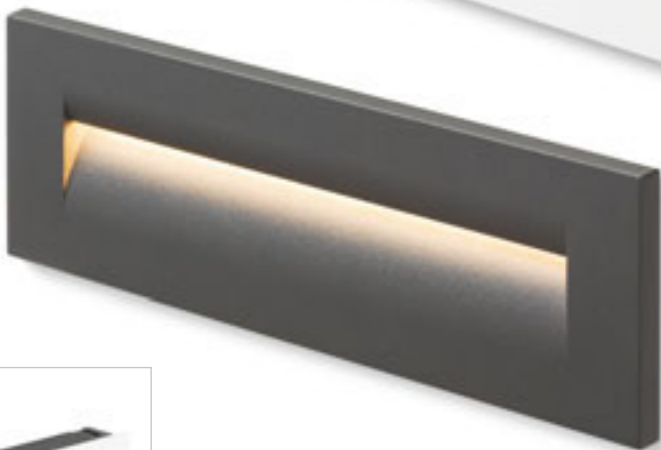

## RASQ

Luminária embutida LED para uso interior e exterior. Adequada como iluminação de orientação de passeios, escadas ou terraços. Instale apenas para iluminação descendente.

### RASQ EMBUTIDO NA PAREDE

230 V LED 9 W 3000 K 190 lm Ra 80 IP65

R12627 branco

€ 178

R12628 cinzento antracite

€ 178

↑ 80

↙ 237x77



LED

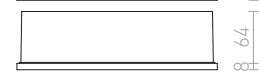
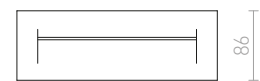

250

86

64

8

IP65



## INTRO

Luminária embutida retangular de alumínio escovado com LED integrado. O painel frontal tem 0,3 cm de espessura. Fornecida com uma caixa de montagem. Apenas para ligação em série.

### INTRO L

350 mA LED 3W 3000 K 185 lm Ra 80

**R10598** alumínio escovado

€ 58 %

↑ 60

■ 86x146



● LED

○ G13124

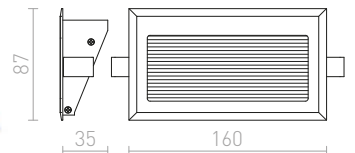





IP65



IP65



IP65



### GORDIQ

Luminária embutida LED para iluminação direcional de pavimentos, escadas ou terraços. Apenas para iluminação descendente.

#### GORDIQ L EMBUTIDA

230 V LED 3 W 3000 K 90 lm Ra 80 IP65

R12537 branco

€ 68

R12538 cinzento antracite

€ 68

↑ 60

▣ 115x50

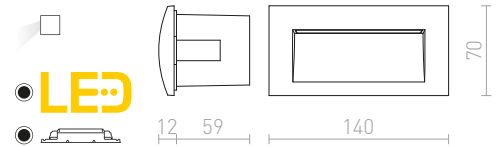

LED



#### GORDIQ M EMBUTIDA

230 V LED 3 W 3000 K 90 lm Ra 80 IP65

R12535 branco

€ 88

R12536 cinzento antracite

€ 88

↑ 60

▣ 115x108

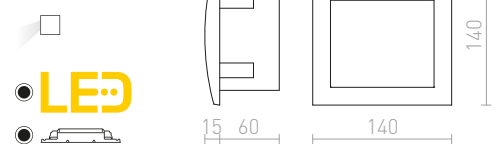

LED



#### GORDIQ S EMBUTIDA

230 V LED 1,5 W 3000 K 30 lm Ra 80 IP65

R12533 branco

€ 58

R12534 cinzento antracite

€ 58

↑ 60

▣ 75x72

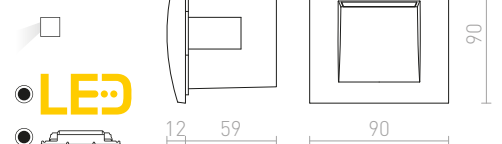

LED





IP65



IP65



## DEJAVU

Luminária embutida LED para montagem em parede.  
Adequada para iluminação direcional de pavimentos,  
escadas ou terraços.

### DEJAVU SQ 9 EMBUTIDA

230 V LED 3,5W 3000 K 120 lm Ra 80 IP65

R12530 preto

€ 58 %

↑ 70  
72x75

● LED

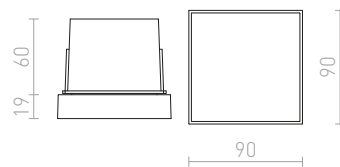

### DEJAVU SQ 14 EMBUTIDA

230 V LED 6 W 3000 K 270 lm Ra 80 IP65

R12531 preto

€ 78 %

↑ 70  
108x125

● LED

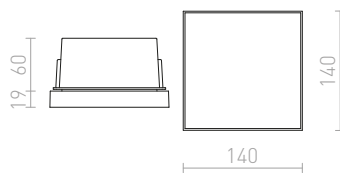







## CALHAS TRIFÁSICAS

3F TRIFÁSICO	490-495
3F FOCOS	496-513
3F SUSPENSOS	514-531

## SISTEMA DE CALHAS MONOFÁSICAS

MONOFÁSICO	532-535
1F FOCOS	536-545
1F SUSPENSOS	546-555

## FITAS LED

FITAS LED	556-561
PERFIS	562-565



## CALHAS TRIFÁSICAS 3F TRIFÁSICO



**EUTRAC 1m**  
490-495



**EUTRAC 2m**  
490-495



**EUTRAC 3m**  
490-495

490-495

## CALHAS TRIFÁSICAS 3F FOCOS



**FLATLINE 60**  
496-497



**FLATLINE 150**  
496-497



**FOCUS 12**  
498-499

496-513



**FOCUS 20**  
498-499



**FOCUS 30**  
498-499



**WISH 20**  
500-501



**WISH 30**  
500-501



**OPTIMUS**  
500-501



**ZUMA**  
500-501



**MAVRO**  
502-503



**LOLLIPOP**  
502-503



**TRAX**  
502-503



**MAVRO**  
502-503



**BAHIA**  
504-505



**PRODIGIS**  
504-505



**FANGIO**  
504-505



**DARIO**  
506-507



**CONNOR**  
506-507



**CADENZA**  
506-507



**FORZA**  
508-509



**BELENOS**  
508-509



**DUDE**  
508-509



**BEEBA I**  
510-511



**BEEBA II**  
510-511



**PURINA**  
510-511



**TRICA**  
510-511



**PIXIE**  
512-513



**PIXIE**  
512-513



**KELLY LED**  
512-513



**FAX E27**  
512-513



**FAX**  
512-513

## CALHAS TRIFÁSICAS 3F SUSPENSOS



**LUNA 20**  
514-515



**LUNA 25**  
514-515



**LUNA 30**  
514-515

514-531



**JULIETTA 16**  
516-517



**JULIETTA 31**  
516-517



**COPA**  
516-517



**BELLINI**  
516-517



**SANSSOUCI**  
518-519



**GARNISH**  
518-519



**EIGHT**  
518-519



**CHOUPETTE**  
520-521



**GIULIA 12**  
520-521



**GIULIA 20**  
520-521



**ARAQ**  
520-521



**AGNETA**  
522-523



**BLONDIE 25**  
522-523



**ASTON**  
522-523



**BUCKY 40**  
524-525



**MONROE 30**  
524-525

**SINTRA 30**  
524-525

**BABADES**  
526-527

**DESTY**  
526-527

**BELENOS**  
526-527



**MAVRO**  
526-527

**JACK RC**  
528-529

**BURTON**  
528-529

**TUTTI**  
528-529

**FRUTTI**  
528-529



**ELISA**  
530-531

## CALHA MONOFÁSICA MONOFÁSICO

532-535



**1F 1m**  
532-535



**1F 2m**  
532-535

## CALHA MONOFÁSICA 1F FOCOS

536-545



**FOCUS 12**  
536-537



**FOCUS 20**  
536-537



**OPTIMUS**  
536-537



**WISH 20**  
538-539

**WISH 30**  
538-539

**MAVRO**  
538-539

**BELENOS**  
540-541

**FORZA**  
540-541



**CADENZA**  
540-541



**DUDE**  
540-541



**CONNOR**  
542-543



**LALA**  
542-543



**SIENA**  
542-543



**DARIO**  
542-543



**TRICA**  
544-545



**PURINA**  
544-545



**BEEBA I**  
544-545



**BEEBA II**  
544-545

## CALHA MONOFÁSICA 1F SUSPENSOS

546-555



**LUNA 20**  
546-547



**LUNA 25**  
546-547



**LUNA 30**  
546-547



**COPA**  
546-547



**BELLINI L E14**  
548-549



**PULIRE RD**  
548-549



**PULIRE CON**  
548-549



**ARAQ**  
548-549



**GIULIA 12**  
550-551



**GIULIA 20**  
550-551



**JULIETTA 16**  
550-551



**JULIETTA 31**  
550-551



**ICAR**  
552-553



**CHOUETTE**  
552-553



**BABADES**  
552-553



**BELENOS**  
552-553



**MAVRO**  
552-553



**ELISA**  
554-555



**BLONDIE 25**  
554-555

**DESTY**  
554-555

**AGNETA**  
554-555

## FITAS LED FITAS LED

556-561



**LED STRIP ORION RGB**  
556-557



**LED STRIP ORION RGBW**  
556-557



**LED STRIP ORION**  
558-559



**Wi-fi ovladač 5v1**  
556-557



**LEDSTRIP ORION 60, 100, 150**  
556-557



**LED STRIP IP54 5m**  
560-561



**LED STRIP IP20 5m**  
560-561



**LED STRIP**  
560-561



**LED STRIP**  
560-561

## FITAS LED PERFIS

562-565



**LED PROFILE G**  
562-563



**LED PROFILE H**  
562-563



**LED PROFILE J**  
562-563



**LED PROFILE I 30/60**  
562-563



**LED PROFILE A**  
564-565



**LED PROFILE B**  
564-565



**LED PROFILE D**  
564-565



# EUTRAC

## CALHA TRIFÁSICA

Calha trifásica EUTRAC. Qualquer perfil pode ser facilmente cortado para o comprimento desejado. Não é necessário cortar ou dobrar as extremidades dos fios. Ao usar fontes de halogéneo, a altura mínima de instalação é de 2,5 m. Para uso abaixo desta altura, recomendamos a substituição por fontes de LED. NOTA: Custos adicionais de frete podem ocorrer em pedidos de 3 m de calhas.

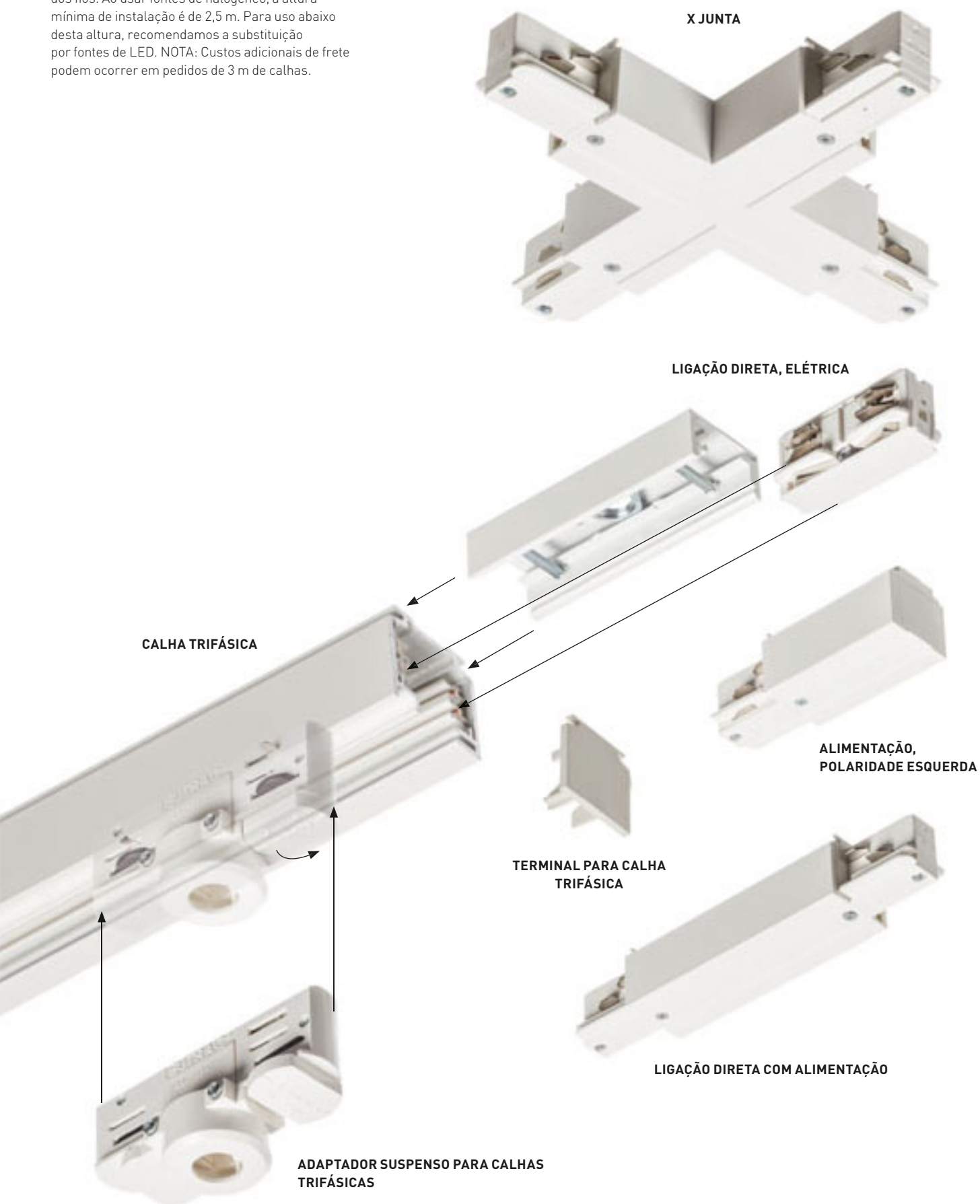

L JUNTA POLARIDADE INTERNA



L JUNTA POLARIDADE EXTERNA



SUSPENSÃO DE ARAME



JUNTA CONETORA PARA CALHAS TRIFÁSICAS



BRAÇADEIRA PARA CALHAS TRIFÁSICAS

LIGAÇÃO DIRETA COM ALIMENTAÇÃO

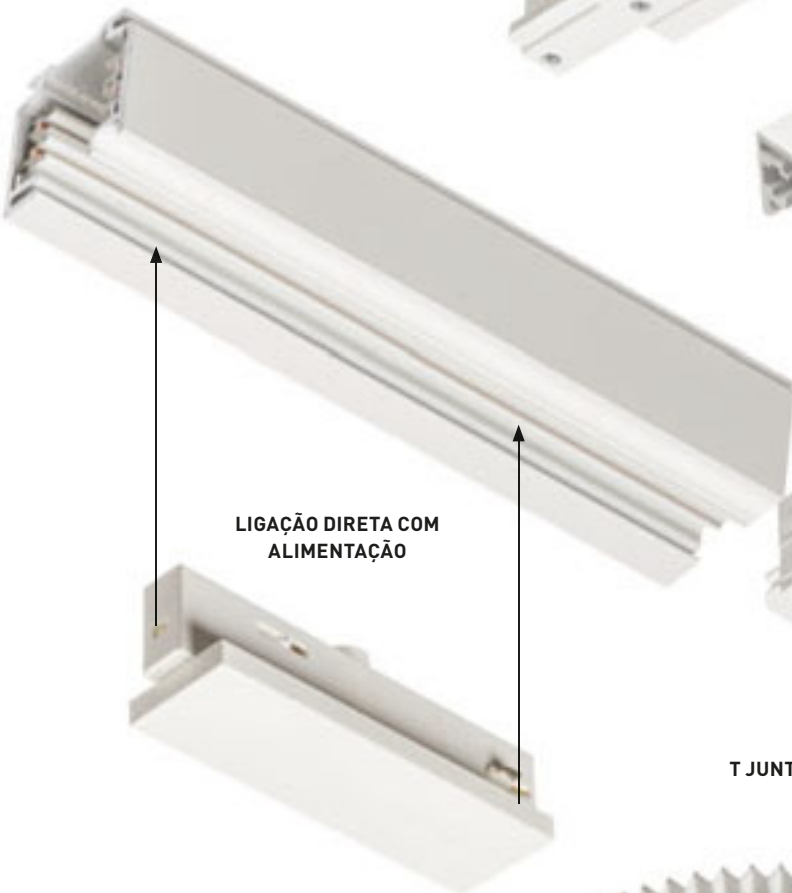

T JUNTA, POLARIDADE ESQUERDA

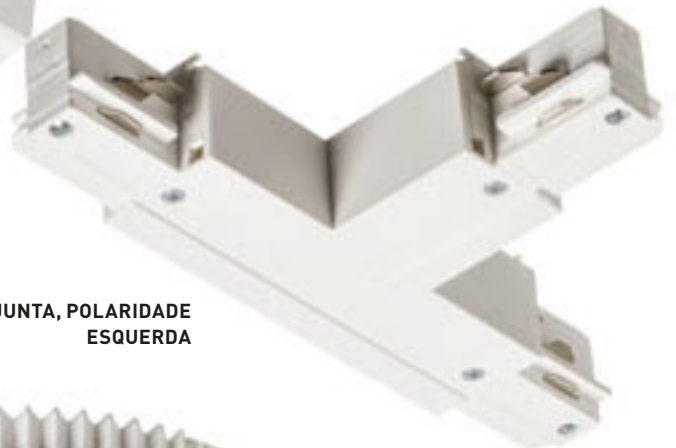

LIGAÇÃO FLEXÍVEL



ADAPTADOR MECÂNICO



# EUTRAC

## CALHA TRIFÁSICA

Calha trifásica EUTRAC. Qualquer perfil pode ser facilmente cortado para o comprimento desejado. Não é necessário cortar ou dobrar as extremidades dos fios. Ao usar fontes de halogéneo, a altura mínima de instalação é de 2,5 m. Para uso abaixo desta altura, recomendamos a substituição por fontes de LED. NOTA: Custos adicionais de frete podem ocorrer em pedidos de 3 m de calhas.

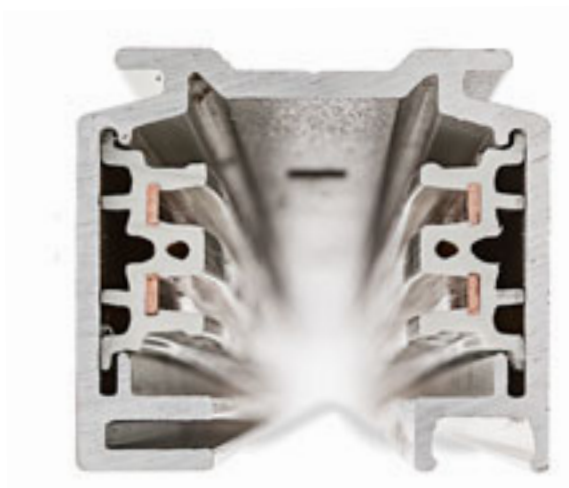

### 1M CALHA TRIFÁSICA

230 V	
<b>R12072</b> branco	<b>€ 98</b>
<b>R12073</b> preto	<b>€ 98</b>
<b>R12074</b> cinzento prata	<b>€ 98</b>

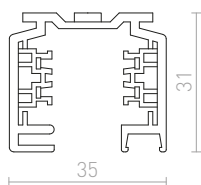

### L JUNTA POLARIDADE INTERNA

L-ligação com fonte de alimentação para calha trifásica EUTRAC. Carga máxima 16A.

230 V	
<b>R11326</b> branco	<b>€ 78</b>
<b>R11327</b> preto	<b>€ 78</b>
<b>R11328</b> cinzento prata	<b>€ 120</b>

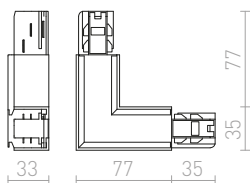

### L JUNTA POLARIDADE EXTERNA

Ligação em L com fonte de alimentação para calhas trifásicas EUTRAC. Carga máxima 16A.

230 V	
<b>R11323</b> branco	<b>€ 78</b>
<b>R11324</b> preto	<b>€ 78</b>
<b>R11325</b> cinzento prata	<b>€ 120</b>

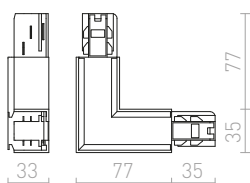

### 2M CALHA TRIFÁSICA

230 V	
<b>R11300</b> branco	<b>€ 158</b>
<b>R11301</b> preto	<b>€ 158</b>
<b>R11302</b> cinzento prata	<b>€ 158</b>

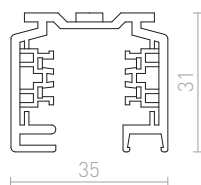

### T JUNTA POLARIDADE DIREITA

Ligação em T com fonte de alimentação para calhas trifásicas EUTRAC. Carga máxima 16A.

230 V	
<b>R11332</b> branco	<b>€ 120</b>
<b>R11333</b> preto	<b>€ 120</b>
<b>R11334</b> cinzento prata	<b>€ 158</b>

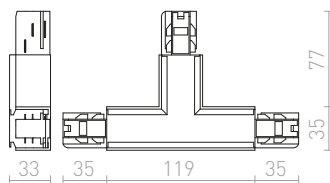

### T JUNTA, POLARIDADE ESQUERDA

Ligação em T com fonte de alimentação para calhas trifásicas EUTRAC. Carga máxima 16A.

230 V	
<b>R11335</b> branco	<b>€ 120</b>
<b>R11336</b> preto	<b>€ 120</b>
<b>R11337</b> cinzento prata	<b>€ 158</b>

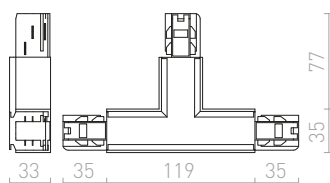

### 3M CALHA TRIFÁSICA

230 V	
<b>R11303</b> branco	<b>€ 238</b>
<b>R11304</b> preto	<b>€ 238</b>
<b>R11305</b> cinzento prata	<b>€ 238</b>

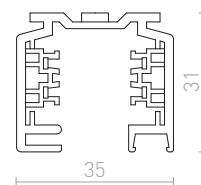

### ALIMENTAÇÃO, POLARIDADE DIREITA

Fonte de alimentação terminal para calhas trifásicas EUTRAC. Carga máxima 16A.

230 V	
<b>R11311</b> branco	<b>€ 35</b>
<b>R11312</b> preto	<b>€ 35</b>
<b>R11313</b> cinzento prata	<b>€ 48</b>

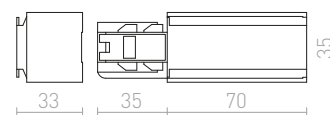

### ALIMENTAÇÃO, POLARIDADE ESQUERDA

Fonte de alimentação terminal para calhas trifásicas EUTRAC. Carga máxima 16A.

230 V	
<b>R11314</b> branco	<b>€ 35</b>
<b>R11315</b> preto	<b>€ 35</b>
<b>R11316</b> cinzento prata	<b>€ 48</b>

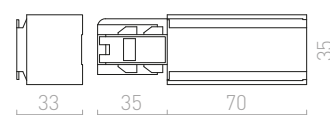

**LIGAÇÃO DIRETA, ELÉTRICA**

Articulação condutora longitudinal para calhas trifásicas EUTRAC. Por razões estáticas, é necessária uma junta mecânica (R11354, R11355 ou R11356) para a montagem da suspensão. Carga máxima 16A.

230 V

<b>R11317</b> branco	<b>€ 24</b>
<b>R11318</b> preto	<b>€ 24</b>
<b>R11319</b> cinzento prata	<b>€ 29</b>

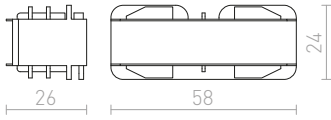

**LIGAÇÃO FLEXÍVEL**

Articulação condutora flexível para calhas trifásicas EUTRAC. Raio 30° -330°. Com esta ligação é possível alimentar o sistema de calhas. Carga máxima 16A.

230 V

<b>R11329</b> branco	<b>€ 120</b>
<b>R11330</b> preto	<b>€ 120</b>
<b>R11331</b> cinzento prata	<b>€ 120</b>

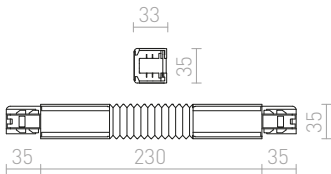

**LIGAÇÃO DIRETA COM ALIMENTAÇÃO**

Ligação longitudinal condutora com fonte de alimentação para calhas trifásicas EUTRAC. Carga máxima 16A.

230 V

<b>R11320</b> branco	<b>€ 78</b>
<b>R11321</b> preto	<b>€ 78</b>
<b>R11322</b> cinzento prata	<b>€ 120</b>



**X JUNTA**

Ligação em X com fonte de alimentação para calhas trifásicas da EUTRAC. Possibilidade de ligar dois circuitos. Carga máxima 16A.

230 V

<b>R11338</b> branco	<b>€ 150</b>
<b>R11339</b> preto	<b>€ 150</b>
<b>R11340</b> cinzento prata	<b>€ 198</b>

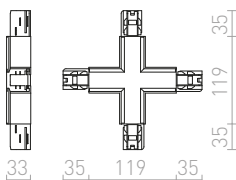

**LIGAÇÃO DIRETA COM ALIMENTAÇÃO**

Fonte de alimentação terminal para calhas trifásicas EUTRAC sem necessidade de dividir a calha. Carga máxima 16A.

230 V

<b>R11346</b> branco	<b>€ 58</b>
<b>R11347</b> preto	<b>€ 58</b>
<b>R11348</b> cinzento prata	<b>€ 78</b>

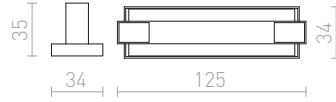

**ADAPTADOR SUSPENSO PARA CALHAS TRIFÁSICAS**

Cargas máximas de 5 kg e 10A.

230 V

<b>R11360</b> branco	<b>€ 32</b>
<b>R11361</b> preto	<b>€ 32</b>
<b>R11362</b> cinzento prata	<b>€ 48</b>

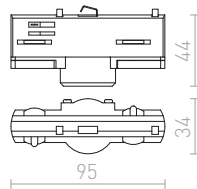

**TERMINAL PARA CALHA TRIFÁSICA**

Terminais para calhas trifásicas EUTRAC.

<b>R11307</b> branco	<b>€ 3.20</b>
<b>R11308</b> preto	<b>€ 3.20</b>
<b>R11309</b> cinzento prata	<b>€ 6</b>

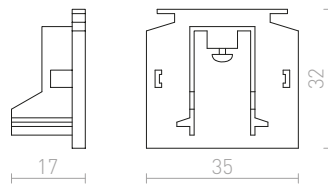

**ADAPTADOR MECÂNICO**

Adaptador mecânico montado em superfície e embutido para calhas trifásicas EUTRAC. Carga máxima de 10 kg.

<b>R11352</b> branco	<b>€ 25</b>
<b>R11353</b> preto	<b>€ 25</b>

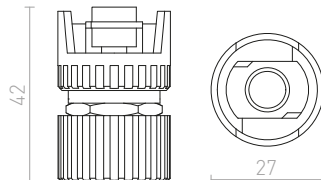

**3M SUSPENSÃO DE ARAME**

Fios para calhas trifásicas EUTRAC. Casquilho M13.

<b>R11359</b>	<b>€ 48</b>
---------------	-------------

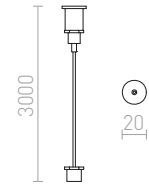

**1,5M SUSPENSÃO DE ARAME**

Fios para calhas trifásicas EUTRAC. Casquilho M13.

<b>R11358</b>	<b>€ 48</b>
---------------	-------------

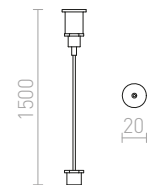

**BRACEIRA PARA CALHAS TRIFÁSICAS**

Adaptador para fixar o cabo suspenso. Casquilho M13.

<b>R11349</b> branco	<b>€ 14</b>
<b>R11350</b> preto	<b>€ 14</b>
<b>R11351</b> cinzento prata	<b>€ 16</b>

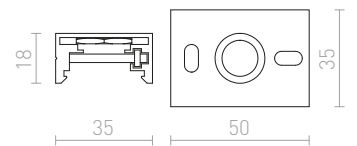

**JUNTA CONETORA PARA CALHAS TRIFÁSICAS**

A junta mecânica deve ser utilizada para reforçar os sistemas de calhas suspensas no ponto de interligação de cada calha com uma ligação condutora longitudinal.

<b>R11354</b> branco	<b>€ 24</b>
<b>R11355</b> preto	<b>€ 24</b>
<b>R11356</b> cinzento prata	<b>€ 26</b>

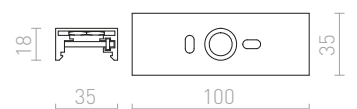

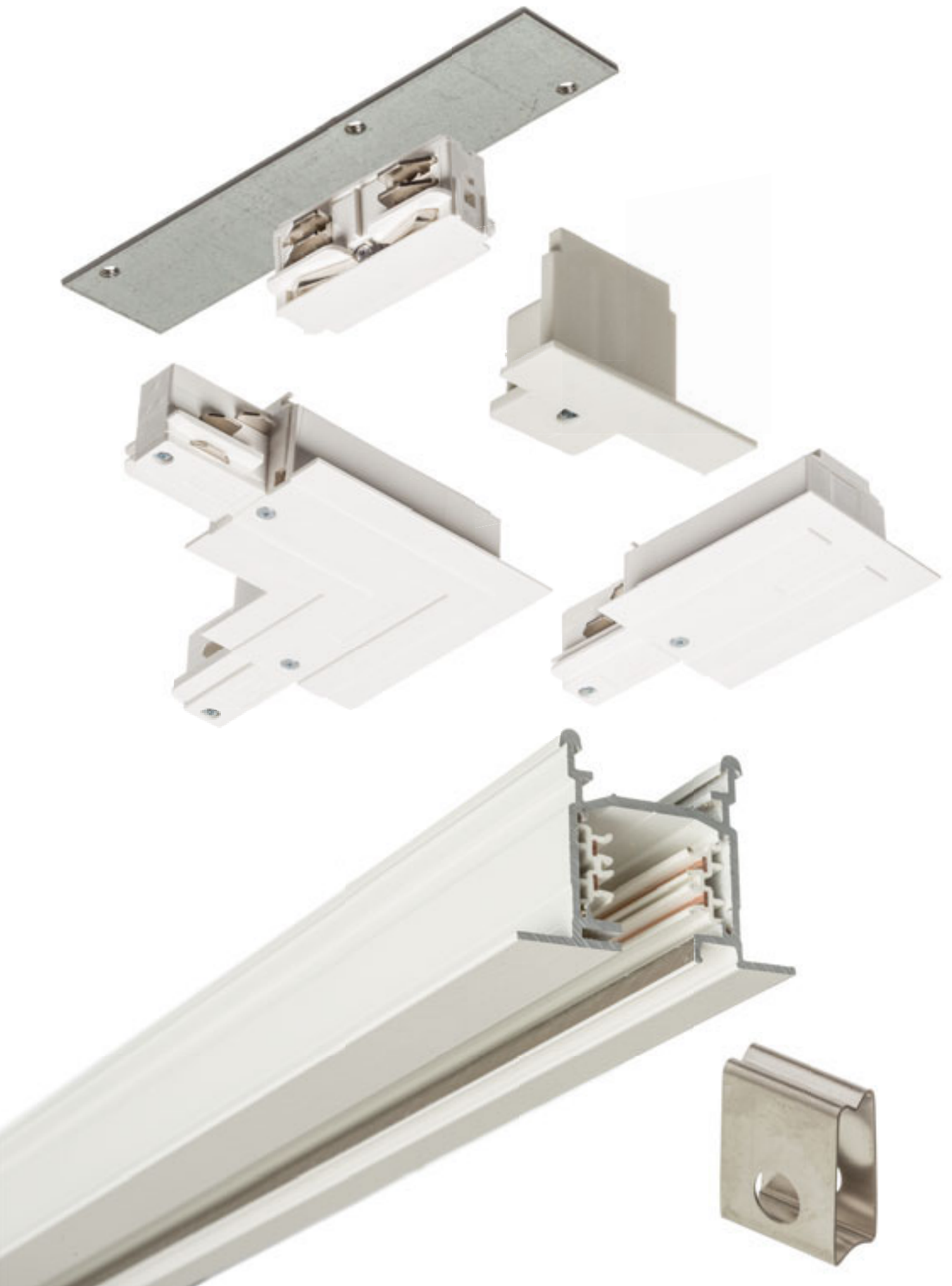

**CALHA TRIFÁSICA EMBUTIDA**

Sistema de calha trifásica embutida em perfil de alumínio extrudido, que também serve de aterramento. No interior, são inseridos dois perfis de plástico, levando quatro fios de cobre de 2,5 mm de diâmetro. Qualquer perfil pode ser facilmente cortado para o comprimento desejado. Não é necessário cortar ou dobrar as extremidades dos fios. Ao usar fontes de halógeno, a altura mínima de instalação é de 2,5 m. Abaixo desta altura, recomendamos a substituição de fontes LED.

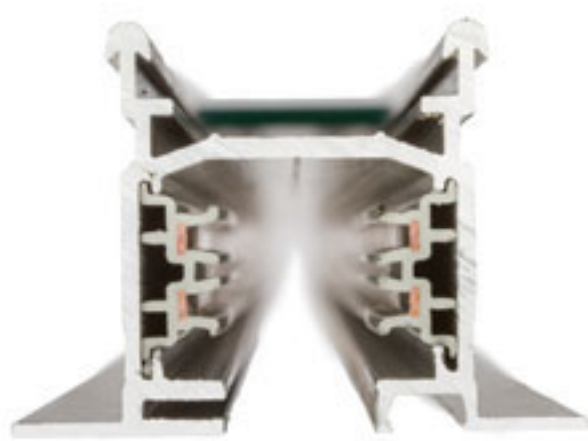

**ALIMENTAÇÃO PARA CALHAS TRIFÁSICAS EMBUTIDAS, POLARIDADE ESQUERDA**

Fonte de alimentação terminal para calha trifásica embutida EUTRAC. Possibilidade de carregar até 16A.

230 V  
**R11342** branco € 48

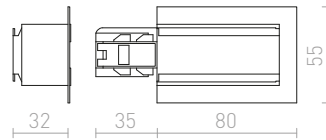

**ALIMENTAÇÃO PARA CALHAS TRIFÁSICAS EMBUTIDA, POLARIDADE DIREITA**

Fonte de alimentação terminal para calha trifásica embutida EUTRAC. Possibilidade de carregar até 16A.

230 V  
**R11341** branco € 48

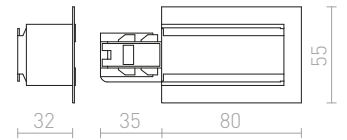

**L LIGAÇÃO PARA CALHAS TRIFÁSICAS EMBUTIDAS (POLARIDADE EXTERNA)**

Ligação em L com fonte de alimentação para calhas trifásicas EUTRAC. Carga máxima 16A.

230 V  
**R11344** branco € 88

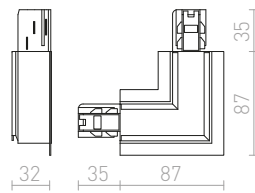

**L LIGAÇÃO PARA CALHAS TRIFÁSICAS EMBUTIDAS (POLARIDADE INTERNA)**

Ligação em L com fonte de alimentação para calha trifásica EUTRAC. Carga máxima 16A.

230 V  
**R11345** branco € 88

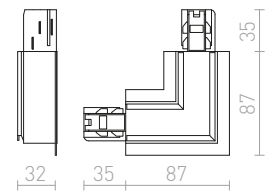

**2M CALHA TRIFÁSICA EMBUTIDA**

230 V  
**R11306** branco € 238

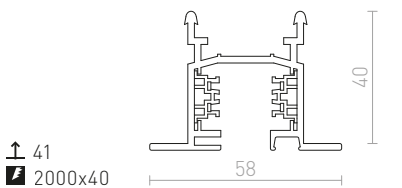

**LIGAÇÃO DIRETA PARA CALHAS TRIFÁSICAS, ELÉTRICA**

Articulação condutora longitudinal para calhas da EUTRAC. Capacidade de carga até 16A.

230 V  
**R11343** branco € 32

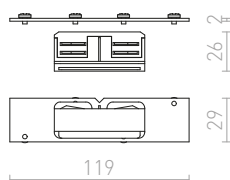

**TERMINAL PARA CALHA TRIFÁSICA**

Terminais para calhas trifásicas embutidas EUTRAC.

**R11310** branco € 8



**MOLAS PARA CALHA TRIFÁSICA EMBUTIDA 6 PCS**

Clipes de montagem para calhas trifásicas EUTRAC embutidas.

**R11357** € 16

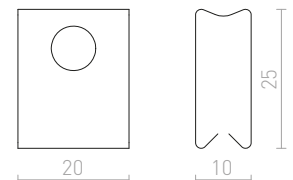





## FLATLINE

Luminária linear com iluminação ambiente para calha trifásica. Uma saída de luz diferente pode ser definida no adaptador de luminária: 35W, 40W, 45W ou 50W.

**FLATLINE 150 PARA CALHA TRIFÁSICA**  
230 V LED 50 W  $\angle 90^\circ$  3000 K 8000 lm Ra 80

R13732 branco

€ 258

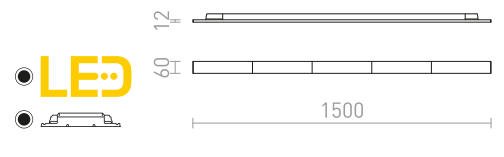

## FLATLINE

Luminária linear com iluminação ambiente para calha trifásica. Uma saída de luz diferente pode ser definida no adaptador de luminária: 14W, 16W, 18W ou 20W.

**FLATLINE 60 PARA CALHA TRIFÁSICA**  
230 V LED 20 W  $\angle 90^\circ$  3000 K 3200 lm Ra 80

R13731 branco

€ 188

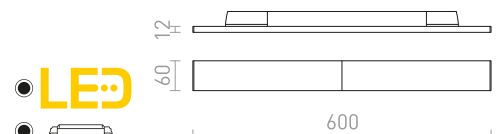







## FOCUS

Foco em forma de tubo regulável para calhas trifásicas com a capacidade de alterar o ângulo do feixe entre 10 - 60° com o chamado sistema Zoom. Também pode alterar a temperatura de cor da luz entre 3000K, 4000K, 5000K com um interruptor localizado na parte de trás da luz. Regulação da intensidade da luz TRIAC.

### FOCUS 12 DIMM PARA CALHA TRIFÁSICA

230 V LED 12 W  $\angle 10-60^\circ$  3000 K 4000 K 5000 K  
780 lm Ra 80

R13882 branco

€ 98 NEW

R13883 preto

€ 98 NEW

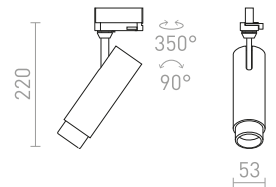

### FOCUS 20 DIMM PARA CALHA TRIFÁSICA

230 V LED 20 W  $\angle 10-60^\circ$  3000 K 4000 K 5000 K  
1540 lm Ra 80

R13884 branco

€ 120 NEW

R13885 preto

€ 120 NEW

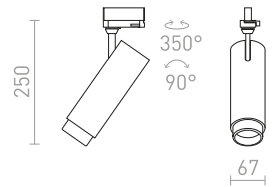

### FOCUS 30 DIMM PARA CALHA TRIFÁSICA

230 V LED 30 W  $\angle 10-60^\circ$  3000 K 4000 K 5000 K  
2300 lm Ra 80

R13886 branco

€ 150 NEW

R13887 preto

€ 150 NEW

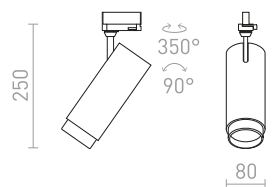



## ZUMA

Foco tubular para calhas trifásicas com a possibilidade de ajustar o cone de luz usando um sistema de zoom de 10-50°. Regulação da intensidade da luz TRIAC.

### ZUMA DIMM PARA CALHA TRIFÁSICA

230 V LED 20 W  $\angle 10-50^\circ$  3000 K 1000 lm Ra 80

R13529 branco

€ 129

R13531 preto

€ 129

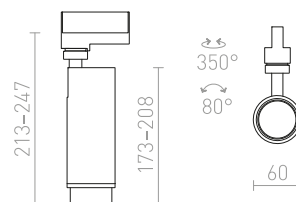

## OPTIMUS

Foco cilíndrico para calha trifásica com possibilidade de ajuste do cone de luz mediante sistema de zoom 10-50°. A luminária é adequada para fontes de luz LED com casquilho GU10. Use fontes de luz com um ângulo de feixe de 120° na luminária para evitar sombras indesejadas.

### OPTIMUS PARA CALHA TRIFÁSICA

230 V LED GU10 9 W  $\angle 10-50^\circ$

R13783 branco

€ 68

R13784 preto

€ 68

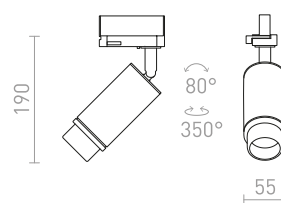



## WISH

Luminária cilíndrica regulável para calha monofásica ajustável de cor clara: branco quente (WW), branco neutro (NW), branco frio (CW). Regulação da intensidade da luz TRIAC.

### WISH 20 DIMM PARA CALHA TRIFÁSICA

230 V LED 20 W  $\angle 36^\circ$  3000 K 4000 K 5000 K  
1600 lm Ra 80

R13773 branco

€ 120 NEW

R13774 preto

€ 120 NEW

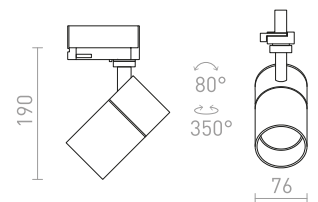

### WISH 30 DIMM PARA CALHA TRIFÁSICA

230 V LED 30 W  $\angle 36^\circ$  3000 K 4000 K 5000 K  
2400 lm Ra 80

R13775 branco

€ 129 NEW

R13776 preto

€ 129 NEW

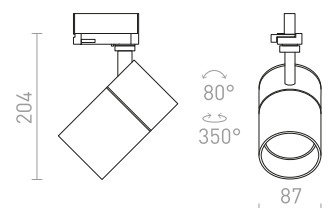



## LOLLIPOP

Foco LED cilíndrico para calhas trifásicas. Módulo de LED incluído.

### LOLLIPOP PARA CALHA TRIFÁSICA

230 V LED 8 W  $\angle 40^\circ$  3000 K 620 lm Ra 80

R12412 branco

€ 48 %

R12413 preto

€ 48 %

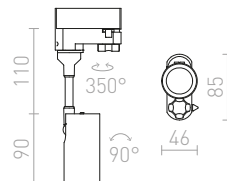

## TRAX

Foco LED minimalista para calha trifásica. Interior e exterior têm cores diferentes.

### TRAX PARA CALHAS TRIFÁSICAS

230 V/400 mA LED 15 W  $\angle 38^\circ$  3000 K 1370 lm Ra 80

R11694 branco/ouro

€ 120 %

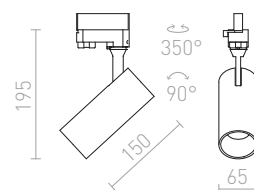

## MAVRO

Foco cilíndrico com LED integrado para calhas trifásicas. TRIAC com regulação da intensidade da luz.

### MAVRO DIMM PARA CALHA TRIFÁSICA

230 V LED 12 W  $\angle 38^\circ$  3000 K 1020 lm Ra 80

R13171 branco

€ 178

R13172 ouro

€ 178 ➔

R13173 preto/ouro

€ 178

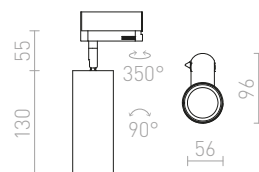

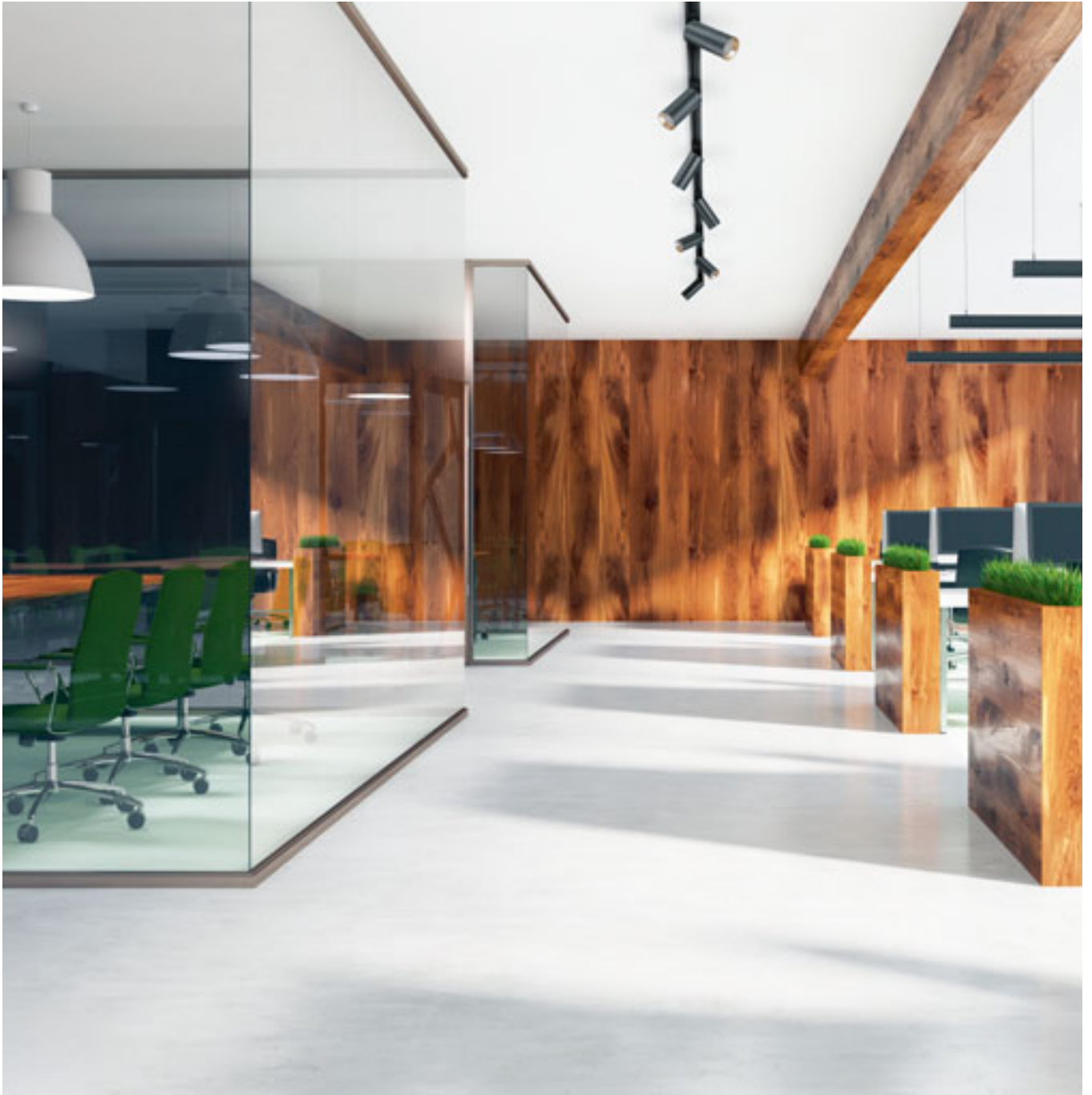

## MAVRO

Foco cilíndrico com LED integrado para calhas trifásicas.

### MAVRO PARA CALHA TRIFÁSICA

230 V LED 12 W  $\angle 38^\circ$  3000 K 1020 lm Ra 80

R12995 branco

€ 120

R12996 ouro

€ 120

R12997 preto/ouro

€ 120

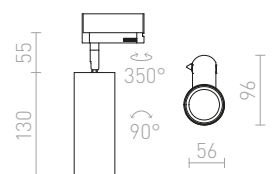



## FANGIO

Foco cilíndrico para calha trifásica, em dois cores diferentes.

### FANGIO PARA CALHA TRIFÁSICA

230 V LED 25 W  $\angle 36^\circ$  3000 K 2200 lm Ra 80

**R12059** cinzento prata

€ 88 %

**R12060** preto

€ 88 %

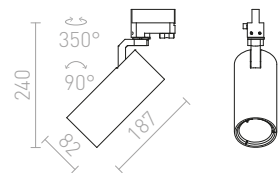



## BAHIA

Foco LED de alta potência para calhas trifásicas.

### BAHIA PARA CALHA TRIFÁSICA

230 V LED 28 W  $\angle 38^\circ$  3000 K 2700 lm Ra 80

R12823 branco

€ 150

R12824 preto

€ 150

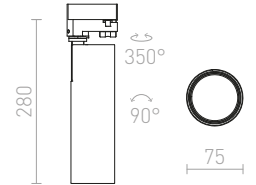

## PRODIGI

Foco cilíndrico para calha trifásica. Disponível numa versão de 10W LED.

### PRODIGI S PARA CALHA TRIFÁSICA

230 V LED 10 W  $\angle 36^\circ$  3000 K 1000 lm Ra 80

R13000 branco

€ 78

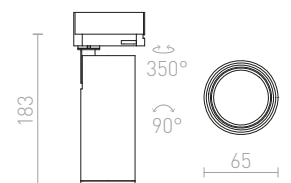



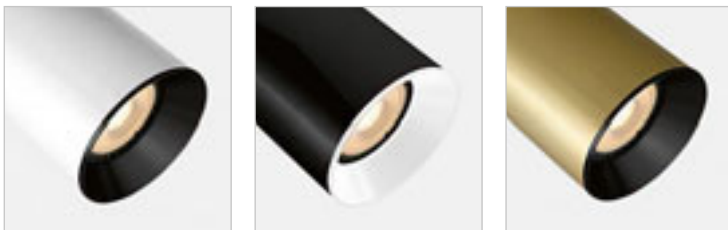
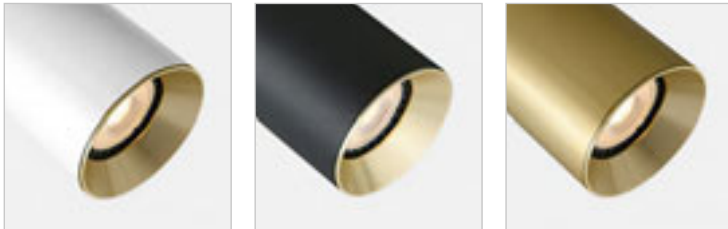

## DARIO

Foco cilíndrico com casquilho GU10 para fontes de luz LED, incluindo um tom decorativo de latão preto escovado. Diferentes combinações de cores estão disponíveis comprando tons adicionais em outras cores. Para uso com calhas trifásicas.

### DARIO PARA CALHA TRIFÁSICA

230 V GU10 9 W

**R13873** branco/latão escovado

€ 98

NEW

**R13874** preto/latão escovado

€ 98

NEW

**R13875** latão escovado

€ 120

NEW

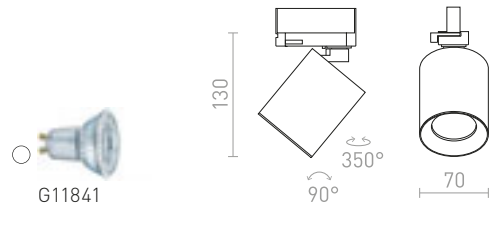

## DARIO

Tonalidade decorativa interna de metal em várias cores para a luz DARIO.

### DARIO ANEL DECORATIVO

**R13876** branco

€ 8.50

NEW

**R13877** preto

€ 8.50

NEW

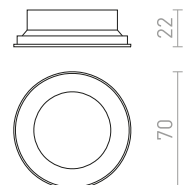



## CADENZA

Foco cilíndrico com casquilho GU10 para calhas trifásicas.

### CADENZA PARA CALHA TRIFÁSICA

230 V LED GU10 10 W

R13348 branco

€ 68

R13349 preto

€ 68

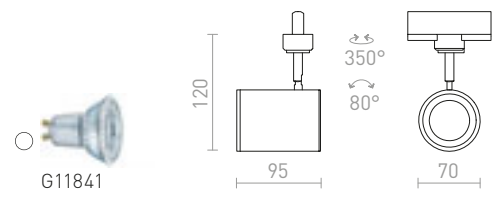

## CONNOR

Foco cilíndrico com casquilho GU10 para calhas trifásicas.

### CONNOR PARA CALHA TRIFÁSICA

230 V LED GU10 10 W

R13499 branco/preto

€ 68

R13500 preto/ouro

€ 68

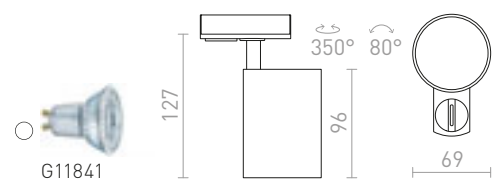



## DUDE

Foco cilíndrico com casquilho GU10 para fontes de luz LED e adaptador para calhas trifásicas.

### DUDE PARA CALHA TRIFÁSICA

230 V LED GU10 9 W

**R13928** branco

€ 58 **NEW**

**R13929** preto

€ 58 **NEW**

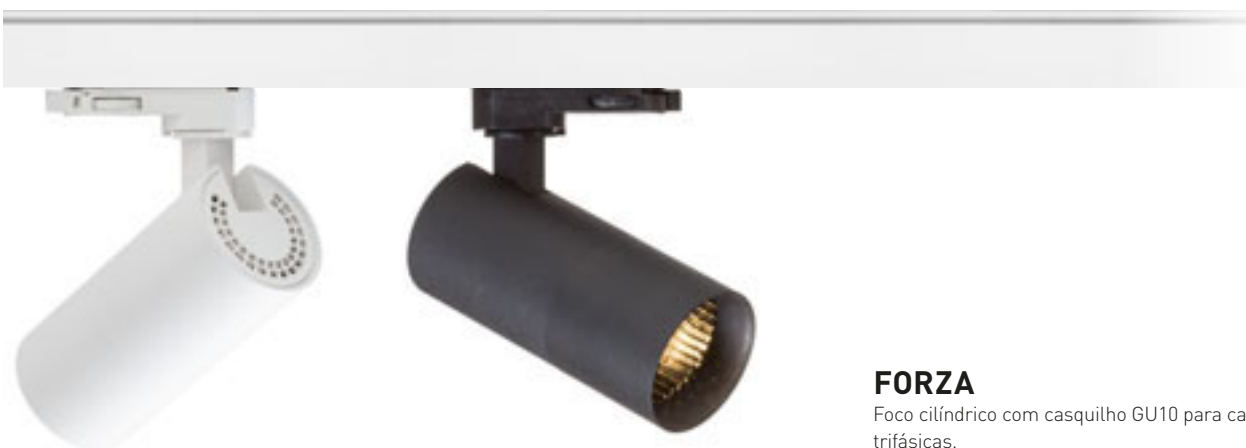
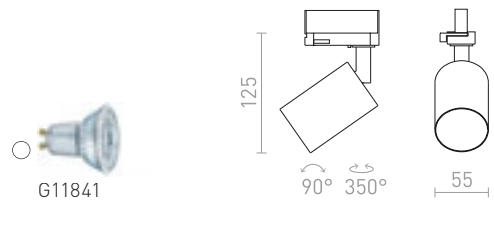

## FORZA

Foco cilíndrico com casquilho GU10 para calhas trifásicas.

### FORZA PARA CALHA TRIFÁSICA

230 V LED GU10 10 W

**R13352** branco

€ 78

**R13353** preto

€ 78

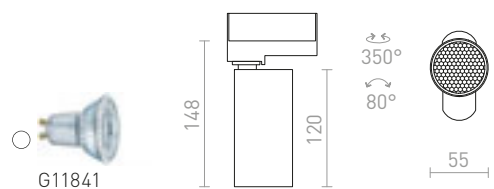

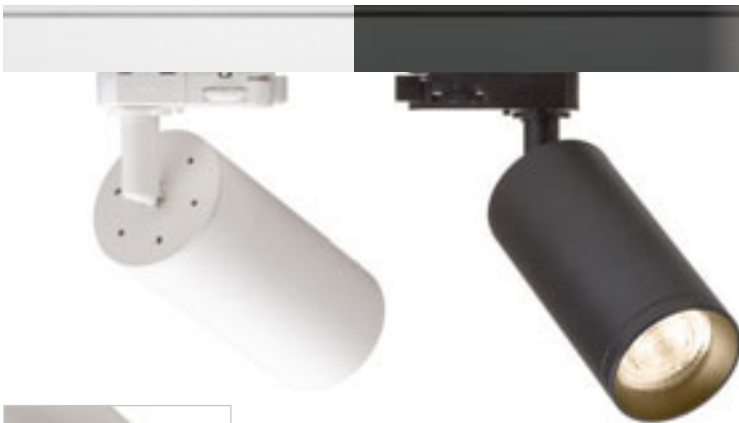
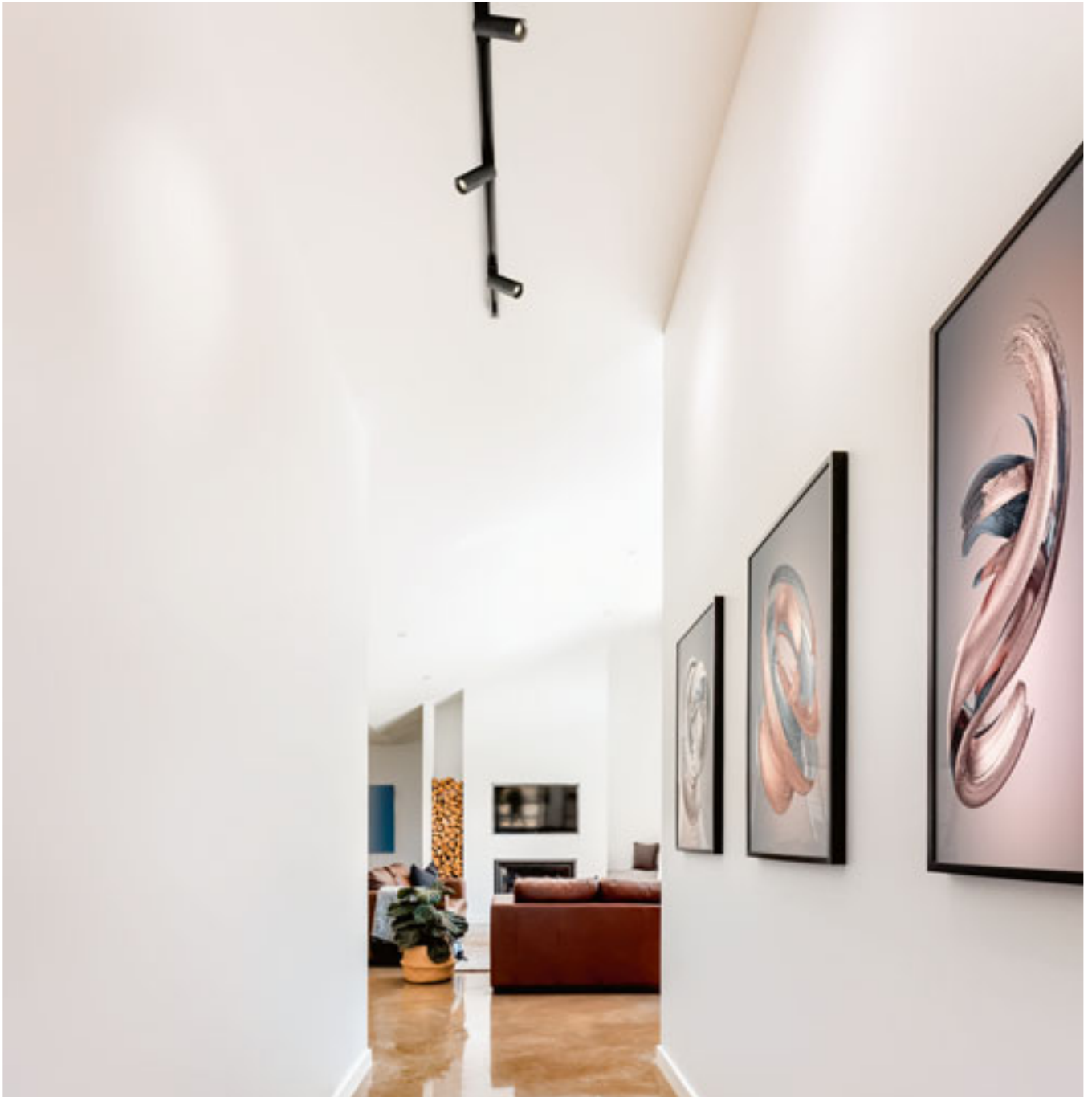

## BELENOS

Foco cilíndrico minimalista com casquilho GU10 para calhas trifásicas. As molas ligadas ao casquilho permitem o uso de fontes de luz de vários comprimentos.

### BELENOS PARA CALHA TRIFÁSICA

230 V LED GU10 9 W

**R13368** branco

€ 68

**R13370** preto

€ 68

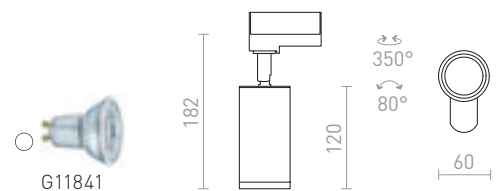

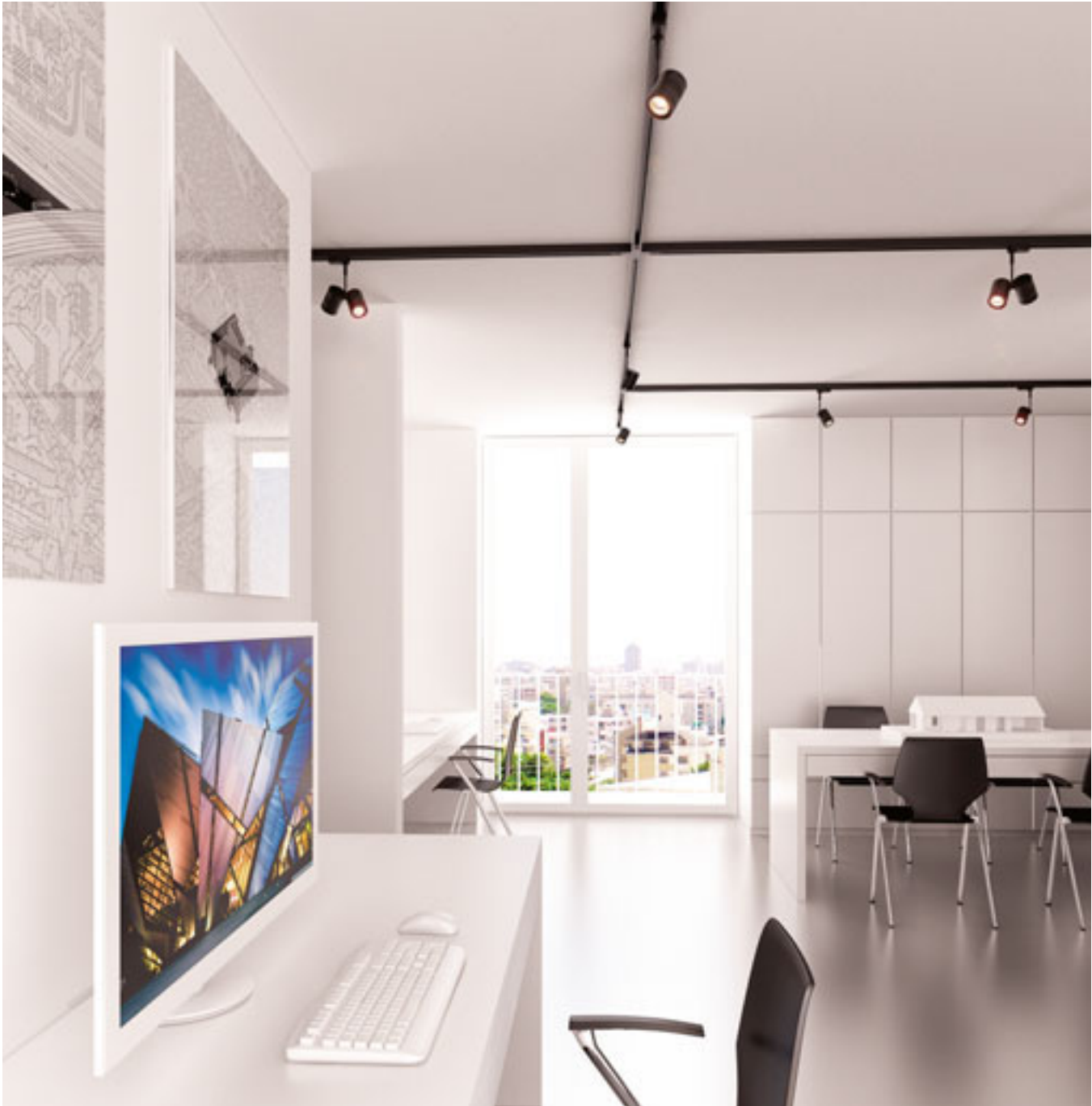

## TRICA

Foco com casquilho GU10 para calhas trifásicas. Podem ser usadas fontes de luz com 111 e 51 mm de diâmetro. Todas as medidas são especificadas sem fonte de luz.

### TRICA PARA CALHA TRIFÁSICA

230 V GU10 50 W

R12006 preto

€ 32

R12007 branco

€ 32



G12723

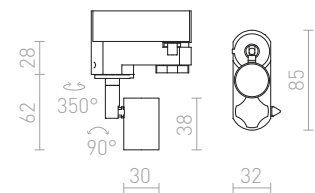



## PURINA

Foco para calhas trifásicas com casquilho GU10 em três cores. Inclui um anel decorativo para fontes de luz com diâmetro de refletor de 51 mm. Fontes de luz ES111 também podem ser usadas nesta luminária.

### PURINA PARA CALHA TRIFÁSICA

230 V GU10 50 W

**R12317** branco € 26 %

**R12318** cinzento prata € 26 %

**R12319** preto € 48 %

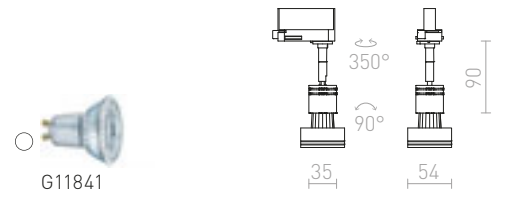

## BEEBA

Foco para calhas trifásicas disponível em três cores.

### BEEBA I PARA CALHA TRIFÁSICA

230 V GU10 35 W

**R12305** branco € 68

**R12306** cinzento prata € 48 %

**R12307** preto € 68

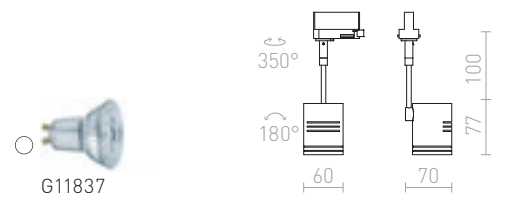

### BEEBA II PARA CALHA TRIFÁSICA

230 V GU10 2x35 W

**R12311** branco € 98

**R12312** cinzento prata € 58 %

**R12313** preto € 98

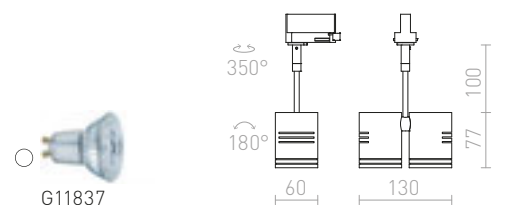



## PIXIE

Foco inclinável de alumínio com adaptador para calha trifásica em três cores. Projetado para fontes de luz LED GX53 de baixo consumo energético.

### PIXIE EM BRAÇO ARTICULADO PARA CALHAS TRIFÁSICAS

230 V LED GX53 7 W

**R10641** cinzento prata/cromo

€ 158 →

**R11768** branco

€ 178

**R11769** preto

€ 178

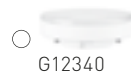

G12340

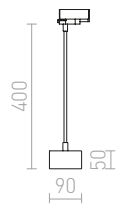

### PIXIE PARA CALHAS TRIFÁSICAS

230 V LED GX53 7 W

**R10640** cinzento prata/cromo

€ 178

**R10644** branco/cromo

€ 178

**R10645** preto/cromo

€ 178

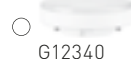

G12340

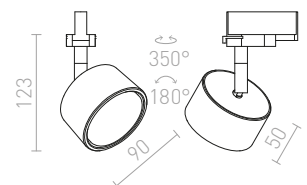



## FAX

Foco para calhas simples, adequado para refletores com casquilho E27.

### FAX E27 PARA CALHA TRIFÁSICA

230 V E27 25 W

R13535 branco

€ 32

R13537 preto

€ 32

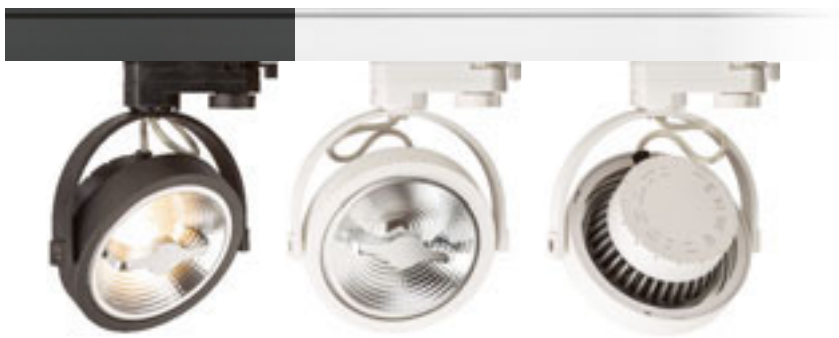
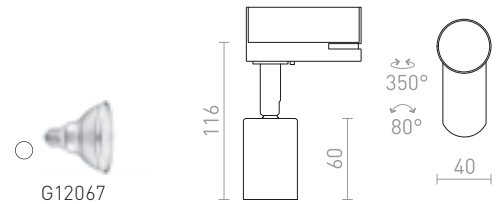

## KELLY LED

Foco para calha trifásica. Módulo de LED incluído.

### KELLY LED PARA CALHA TRIFÁSICA

230 V LED 12 W  $\angle 24^\circ$  3000 K 600 lm Ra 80

R12338 branco

€ 120

R12339 preto

€ 120

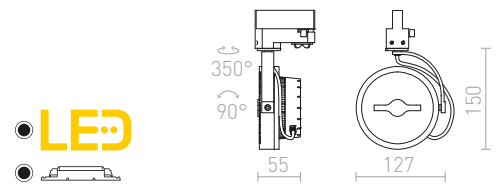

## FAX

Foco para calhas trifásicas com casquilho GU10.

A fonte de luz pode ser usada com um diâmetro de 111 mm ou 51 mm. Dimensões do corpo da luminária  $\varnothing/V$  5/6,5 cm. As dimensões do produto são fornecidas sem fonte de luz.

### FAX PARA CALHA TRIFÁSICA

230 V GU10 50 W

R11724 preto

€ 48

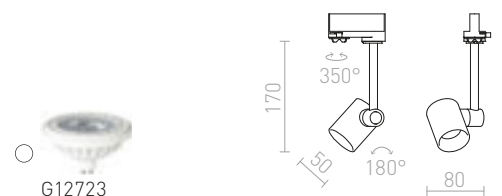







## LUNA

Pendente em vidro de cor opalina com detalhes em cromado e um cabo transparente que está ligado a um adaptador para calhas trifásicas.

### LUNA 20 PARA CALHA TRIFÁSICA

230 V LED E27 15 W

R13967 vidro colorido opala/cromo

€ 129 **NEW**

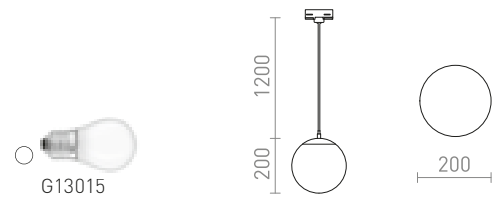

### LUNA 25 PARA CALHA TRIFÁSICA

230 V LED E27 15 W

R13968 vidro colorido opala/cromo

€ 178 **NEW**

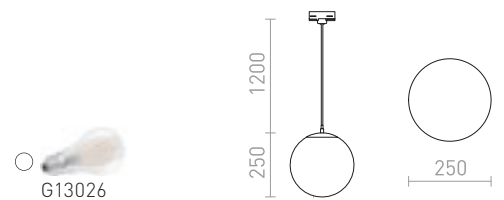

### LUNA 30 PARA CALHA TRIFÁSICA

230 V E27 15 W

R13969 vidro colorido opala/cromo

€ 229 **NEW**

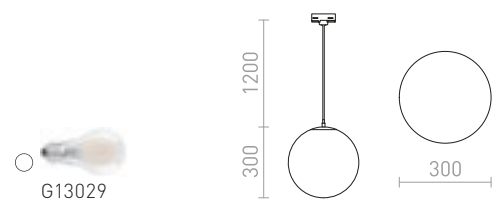



## BELLINI

Luminária suspensa de vidro com acessórios lacados para casquilho LED E14. O cabo de alimentação termina com um adaptador para calha trifásica.

### BELLINI PARA CALHA TRIFÁSICA

230 V E14 15 W

R13814 branco/vidro transparente

€ 215

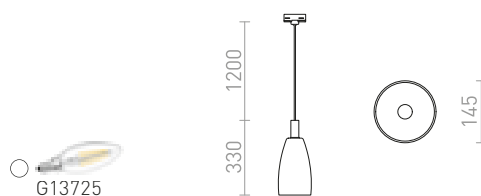

## JULIETTA

Luminária suspensa com abajur cilíndrico de cor opala, detalhes em metal lacado, cabo têxtil preto e adaptador para calhas trifásicas.

### JULIETTA 16 PARA CALHA TRIFÁSICA

230 V E27 20 W

R13855 vidro colorido opala/preto

€ 150

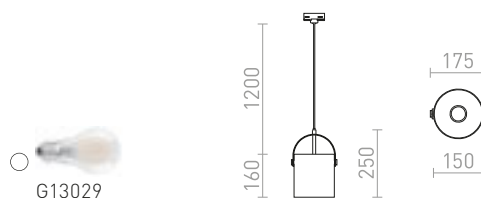

### JULIETTA 31 PARA CALHA TRIFÁSICA

230 V E27 20 W

R13856 vidro colorido opala/preto

€ 178

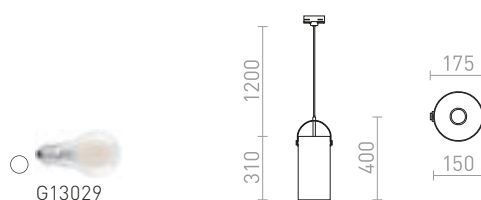



## COPA

Luminária suspensa com abajur de vidro para calha trifásica. Disponível em duas cores.

### COPA PARA CALHA TRIFÁSICA

230 V E27 28 W

**R13207** vidro colorido opala

€ 188

**R13208** preto/vidro

€ 198



G13014

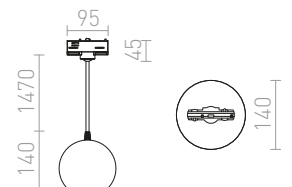



### GARNISH

Luminária suspensa com cortina de vidro transparente e acessórios cromados. A cortina de vidro é fechada na parte inferior e é possível inserir nela decorações adequadas. O cabo de alimentação termina com um adaptador para calha trifásica.

**GARNISH PARA CALHA TRIFÁSICA**  
230 V GU10 9 W

**R13815** vidro transparente/cromo **€ 178**

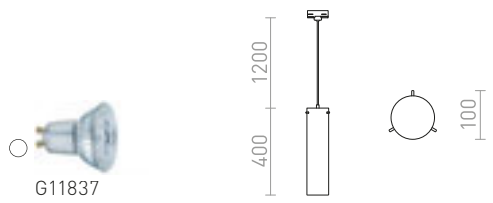

### EIGHT

Luminária suspensa com tonalidade cor opala, detalhes em cromado e adaptador para calhas trifásicas.

**EIGHT SUSPensa PARA CALHA TRIFÁSICA**  
230 V E27 28 W

**R13854** vidro colorido opala/cromo **€ 178**

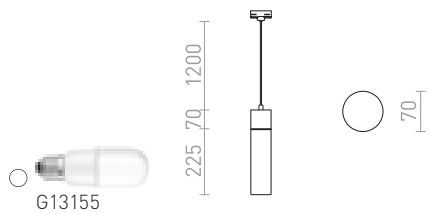



## SANSSOUCI

Luminária suspensa com abajur de vidro para calhas trifásicas. A aparência do abajur é reflexiva quando não está iluminada e parcialmente translúcida quando a luz está acesa.

### SANSSOUCI PARA CALHA TRIFÁSICA

230 V E27 42 W

**R12095** vidro cromado

€ 129 

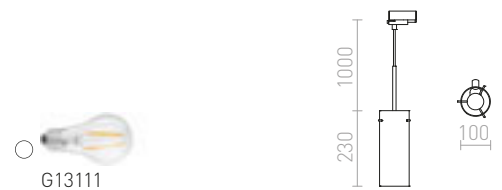

### SANSSOUCI PARA CALHA TRIFÁSICA

230 V E27 42 W

**R12094** vidro tingido de cobre

€ 129 

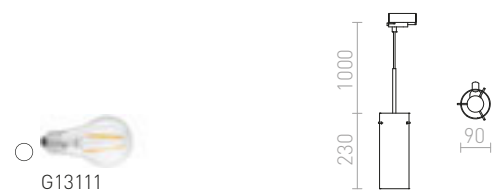



## GIULIA

Candeeiro suspenso com um abajur em metal lacado e um cabo têxtil. O cabo está ligado a um adaptador para calhas trifásicas.

### GIULIA 12 PARA CALHA TRIFÁSICA

230 V E27 40 W

R13990 branco/cromo

€ 88

NEW

R13991 preto/castanho dourado/latão

€ 98

NEW

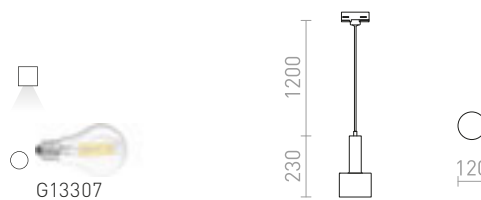

### GIULIA 20 PARA CALHA TRIFÁSICA

230 V E27 40 W

R13992 branco/cromo

€ 98

NEW

R13993 preto/castanho dourado/latão

€ 120

NEW

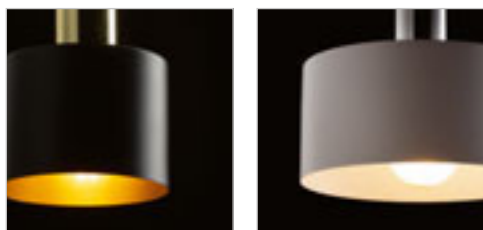
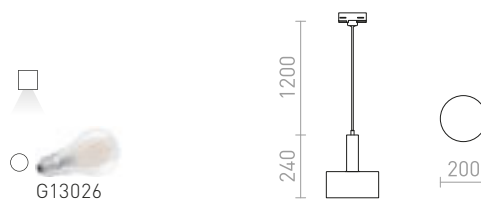



## ARAQ

Pendente com casquilho de latão, cabo têxtil e adaptador para calhas trifásicas. Adequado para lâmpadas decorativas E27.

### ARAQ PARA CALHA TRIFÁSICA SUSPENSO

230 V E27 42 W

R13979 latão escovado/preto

€ 68 **NEW**

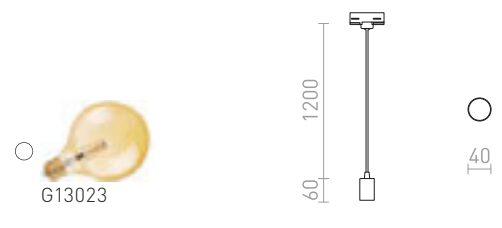

## CHOUETTE

Luminária suspensa em tecido com acessório em madeira para fonte de luz LED com casquilho E27 para instalação em calha trifásica.

### CHOUETTE PARA CALHA TRIFÁSICA

230 V E27 15 W

R13721 cinzento escuro/têxtil/madeira

€ 150

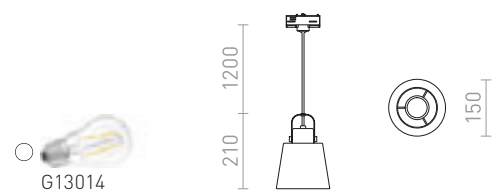



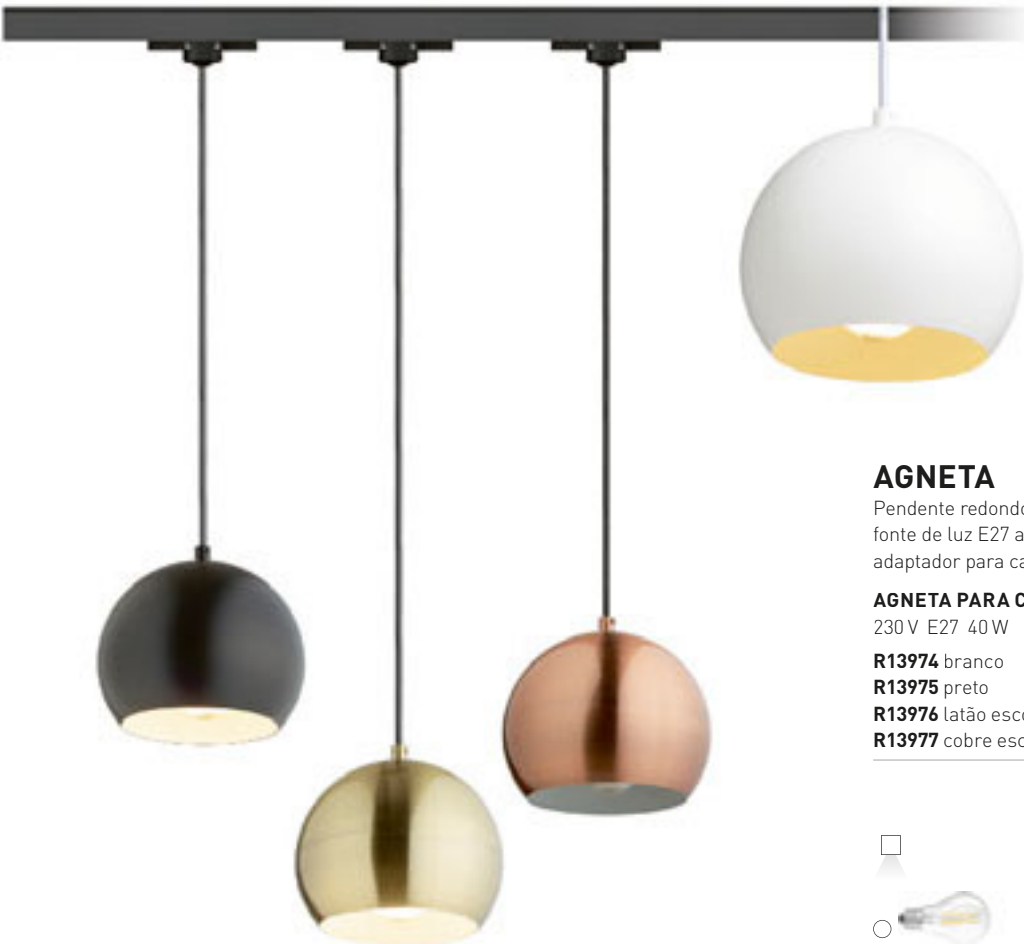

## AGNETA

Pendente redondo em metal para utilização com uma fonte de luz E27 adequada. O cabo está ligado a um adaptador para calhas trifásicas.

### AGNETA PARA CALHA TRIFÁSICA SUSPENSO

230 V E27 40 W

**R13974** branco

€ 98

NEW

**R13975** preto

€ 98

NEW

**R13976** latão escovado

€ 120

NEW

**R13977** cobre escovado

€ 120

NEW

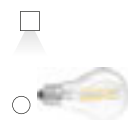

G13307

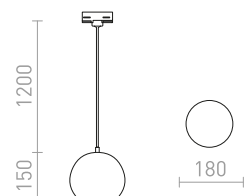



## ASTON

Candeeiro suspenso com abajur de alumínio e adaptador para calhas trifásicas.

### ASTON PARA CALHA TRIFÁSICA

230 V E27 42 W

R12100 alumínio escovado

€ 98 %

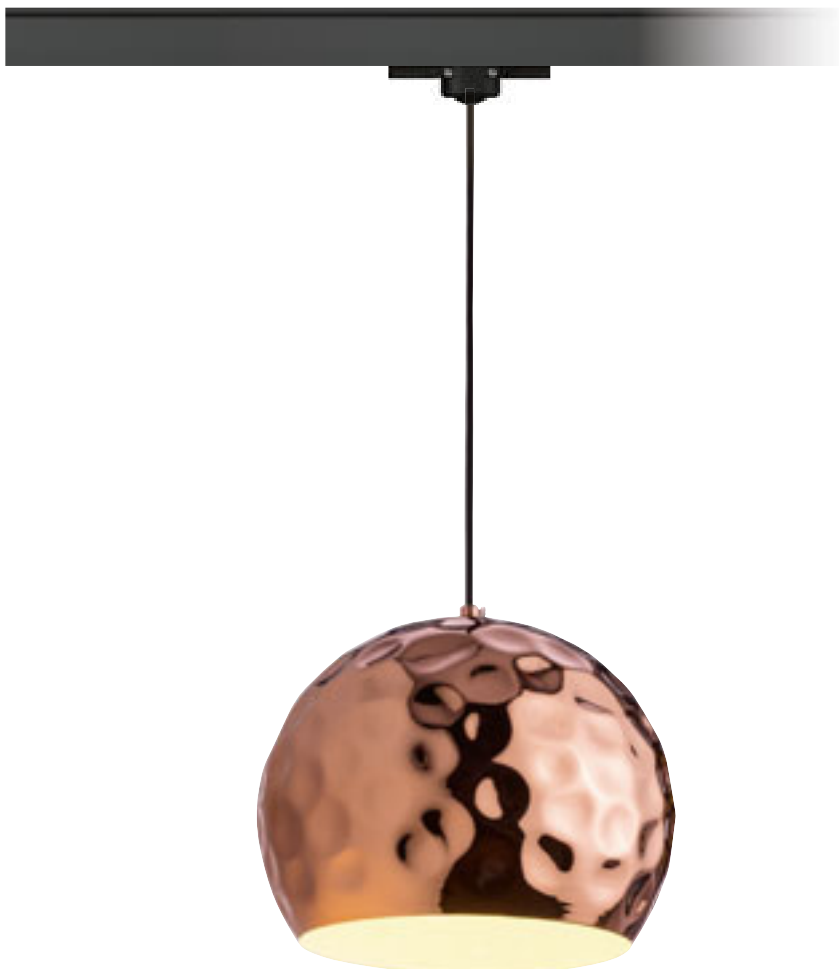
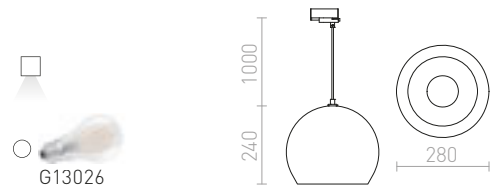

## BLONDIE

Luminária suspensa com abajur metálico texturado. O exterior do abajur é em cobre e o interior lacado a branco. Vendido com um cabo preto PVC e adaptador para calhas trifásicas.

### BLONDIE 25 PARA CALHA TRIFÁSICA

230 V E27 42 W

R13218 cobre

€ 229

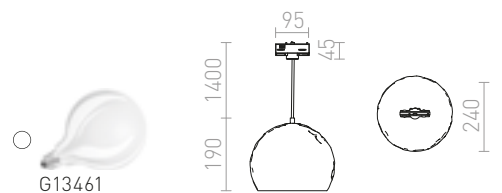



## MONROE

Luminária suspensa com abajur metálico lacado a preto e adaptador para calha trifásica.

### MONROE 30 PARA CALHA TRIFÁSICA

230 V E27 42 W

**R12101** mate preto/branco

€ 178

**R13819** cobre

€ 138

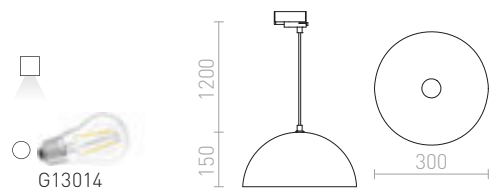



## SINTRA

Candeeiro suspenso com abajur de metal cromado e adaptador para calhas trifásicas.

### SINTRA 30 PARA CALHA TRIFÁSICA

230 V E27 42 W

R12102 cromo

€ 120 %

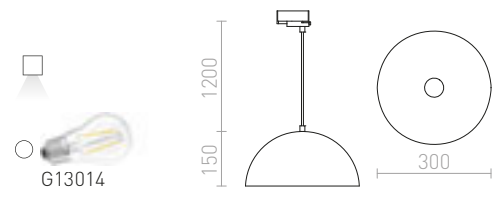

## BUCKY

Luminária suspensa de metal com sombra de textura amassada e adaptador para calhas trifásicas.

### BUCKY 40 PARA CALHA TRIFÁSICA

230 V E27 28 W

R13859 branco/cinza/metal

€ 178

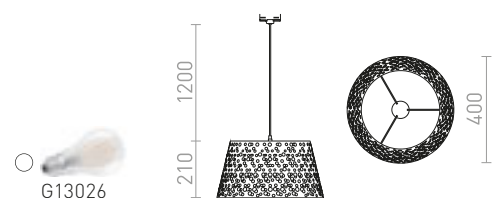



## MAVRO

LED elegante pendente em forma de tubo, adequado para balcões de bar ou ilhas de cozinha. O cabo está ligado a um adaptador para calhas trifásicas.

### MAVRO PARA CALHA TRIFÁSICA SUSPENSO

230 V LED 12 W  $\angle 38^\circ$  3000 K 1020 lm Ra 80

**R13983** branco

€ 150 NEW

**R13984** ouro

€ 150 NEW

**R13985** preto/ouro

€ 150 NEW

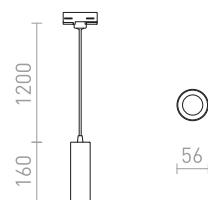



## BELENOS

Luminária suspensa cilíndrica minimalista para fontes de luz GU10 numa base redonda. Molas presas ao casquilho permitem o uso de fontes de luz de vários comprimentos. O cabo é ligado a um adaptador para calhas trifásicas.

**BELENOS SUSPensa PARA CALHA TRIFÁSICA**  
230 V LED GU10 9 W

**R13857** branco

€ 88

**R13858** preto

€ 88

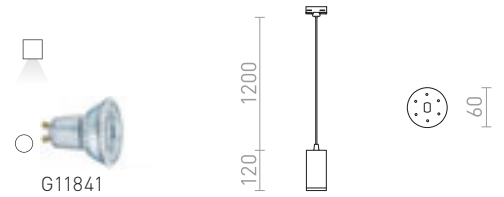

## BABADES

Luminária suspensa com abajur e base de teto em cromo ou níquel mate. Cabo têxtil preto com adaptador para calhas trifásicas.

**BABADES PARA CALHA TRIFÁSICA**

230 V GU10 35 W

**R13216** cromo

€ 88

**R13217** níquel mate

€ 88

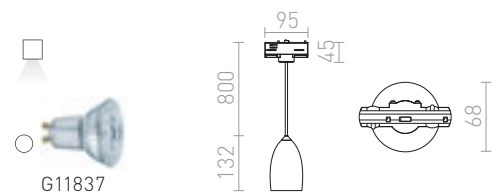

## DESTY

Luminária suspensa com abajur metálico para calha trifásica.

**DESTY PARA CALHA TRIFÁSICA**

230 V GU10 35 W

**R13215** preto/cromo

€ 120

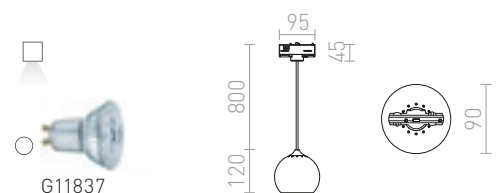



## FRUTTI

Luminária suspensa para casquilho E27. O cabo de alimentação termina com um adaptador para calha trifásica.

### FRUTTI PARA CALHA TRIFÁSICA

230 V E27 28 W

R13818 verde/cerâmica

€ 68

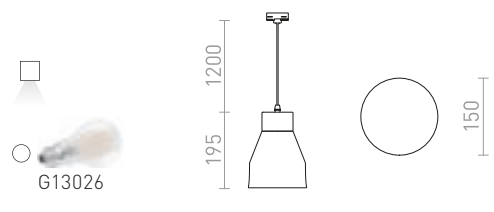

## TUTTI

Luminária suspensa cônica para casquilho E27. O cabo de alimentação termina com um adaptador para calha trifásica. Para iluminação descendente.

### TUTTI PARA CALHA TRIFÁSICA

230 V E27 15 W

R13817 laranja/cerâmica

€ 88

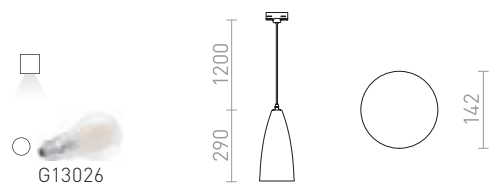

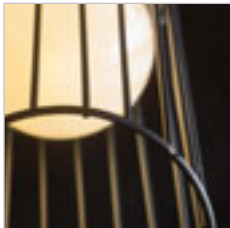

## BURTON

Luminária suspensa em cimento com máscara em fio metálico para casquilho E27. O cabo de alimentação termina com um adaptador para calha trifásica.

### BURTON PARA CALHA TRIFÁSICA

230 V E27 42 W

R13816 cimento/preto

€ 120

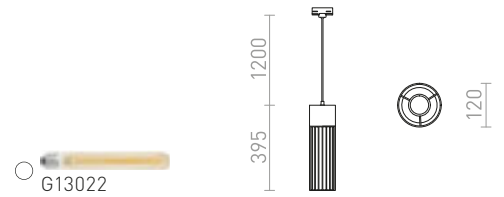

## JACK

Luminária suspensa em gesso para fonte de luz com casquilho GU10. Inclui o adaptador na calha trifásica.

### JACK RC PARA CALHA TRIFÁSICA

230 V GU10 35 W

R12103 gesso

€ 88







R12106  
€ 78

R12107  
€ 98

R12108  
€ 78

R12109  
€ 78

R12110  
€ 78

R12111  
€ 78

R12112  
€ 88

R12113  
€ 88

R12114  
€ 98



## ELISA

Cabo de têxteis em várias combinações de cores com casquilho metálico E27, para uso com uma fonte de luz decorativa ou abajur adequado. O cabo termina com um adaptador para suspensão em calhas trifásicas.

### ELISA PARA CALHA TRIFÁSICA

230V E27 28 W

R12106	€ 78
R12107	€ 98
R12108	€ 78
R12109	€ 78
R12110	€ 78
R12111	€ 78
R12112	€ 88
R12113	€ 88
R12114	€ 98

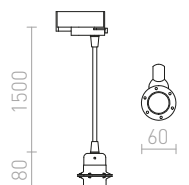

## 1F CALHA

Calha monofásica para sistema deslizante montado em superfície ou suspenso.

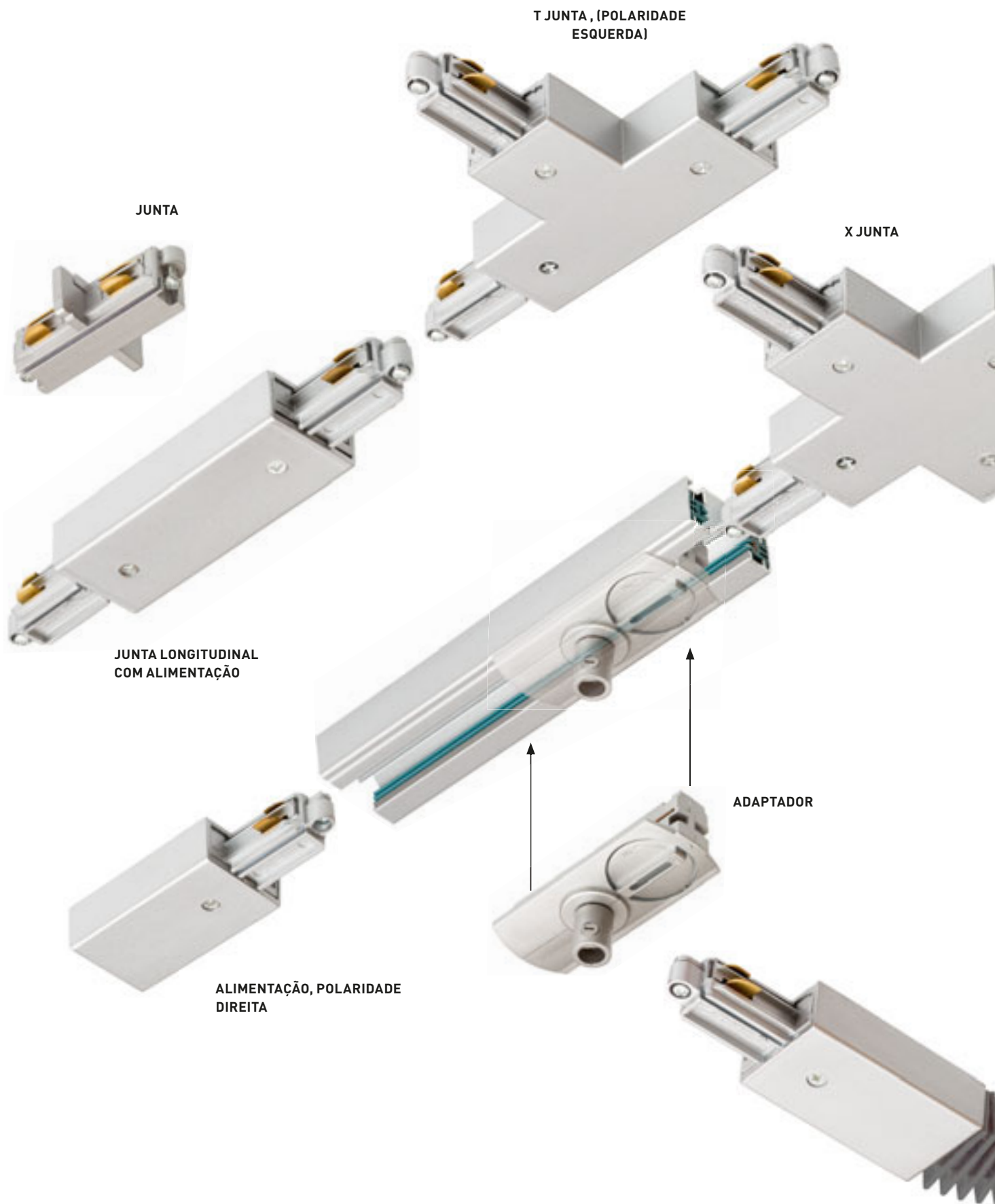

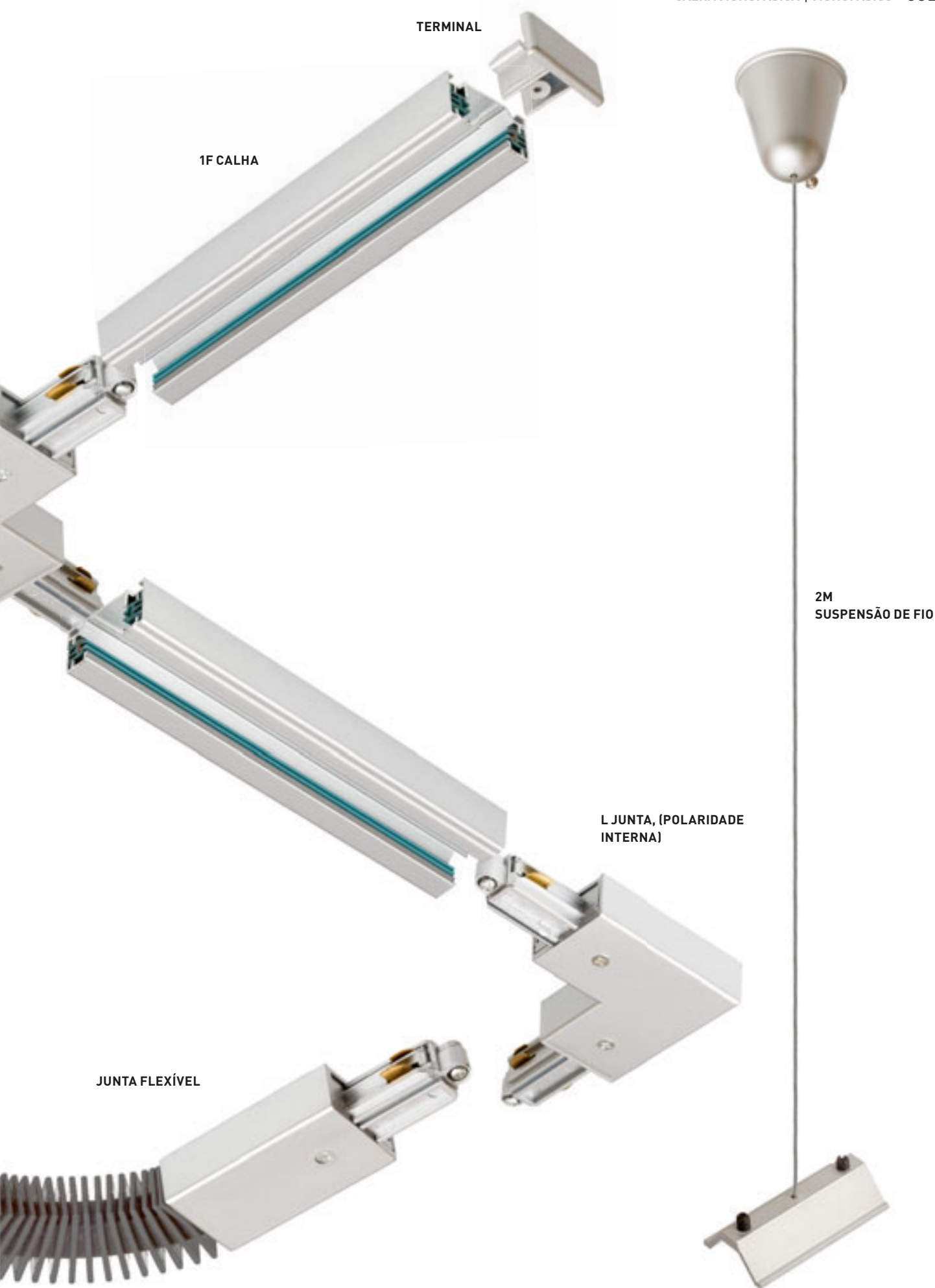

## 1F CALHA

Calha monofásica para sistema deslizante montado em superfície ou suspenso.



## 2M CALHA

Calha monofásica para sistema deslizante ou suspenso.

230 V		
<b>R12257</b> branco	€ 78.00	
<b>R12258</b> preto	€ 78.00	
<b>R12259</b> cinzento prata	€ 78.00	



## 1M CALHA

Calha monofásica para sistema deslizante montado em superfície ou suspenso.

230 V		
<b>R12254</b> branco	€ 38	
<b>R12255</b> preto	€ 38	
<b>R12256</b> cinzento prata	€ 38	



## JUNTA LONGITUDINAL COM ALIMENTAÇÃO

Ligação de energia direta. Carga máxima 16A.

230 V		
<b>R12263</b> branco	€ 9.50	
<b>R12264</b> preto	€ 9.50	
<b>R12265</b> cinzento prata	€ 9.35	



## X JUNTA

Alimentador X-link para calha monofásica. Carga máxima 16A.

230 V		
<b>R12278</b> branco	€ 18.50	
<b>R12279</b> preto	€ 18.50	
<b>R12280</b> cinzento prata	€ 18	

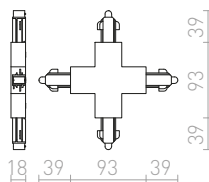

## JUNTA

Ligação condutora para calha monofásica.

230 V		
<b>R12260</b> branco	€ 5.20	
<b>R12261</b> preto	€ 5.35	
<b>R12262</b> cinzento prata	€ 5.20	

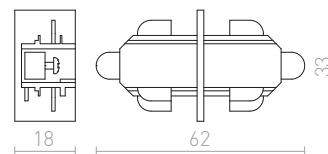

## JUNTA FLEXÍVEL

Articulação flexível para calha monofásica. Raio de curvatura 70° -180°. Carga máxima 16A.

230 V		
<b>R12281</b> branco	€ 16.50	
<b>R12282</b> preto	€ 16.50	
<b>R12283</b> cinzento prata	€ 17.50	

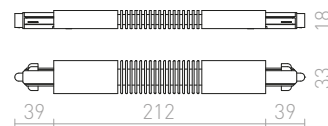



### L JUNTA, (POLARIDADE INTERNA)

Ligação L com fonte de alimentação para calhas monofásicas. Carga máxima 16A.

230 V		
<b>R12269</b> branco		<b>€ 10.50</b>
<b>R12270</b> preto		<b>€ 10.50</b>
<b>R12271</b> cinzento prata		<b>€ 9.80</b>

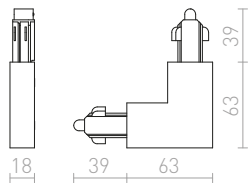

### L JUNTA, (POLARIDADE EXTERNA)

L-ligação com fonte de alimentação para calhas monofásicas. Carga máxima 16A.

230 V		
<b>R12266</b> branco		<b>€ 9.80</b>
<b>R12267</b> preto		<b>€ 9.80</b>
<b>R12268</b> cinzento prata		<b>€ 9.80</b>

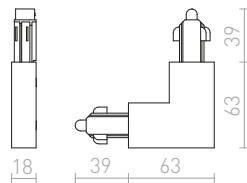

### ADAPTADOR

Adaptador para calha monofásica. Com este adaptador, qualquer luz suspensa com um cabo simples (não pode ser usado para um fio de aço) pode ser usada. Carga máxima 16A. Carga mecânica máxima 20N.

230 V		
<b>R12293</b> branco		<b>€ 9.50</b>
<b>R12294</b> preto		<b>€ 9.50</b>
<b>R12295</b> cinzento prata		<b>€ 9.50</b>

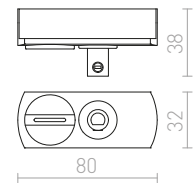

### T JUNTA, (POLARIDADE ESQUERDA)

Ligação T com fonte de alimentação para calhas monofásicas. Carga máxima 16A.

230 V		
<b>R12272</b> branco		<b>€ 12.50</b>
<b>R12273</b> preto		<b>€ 12.50</b>
<b>R12274</b> cinzento prata		<b>€ 13</b>

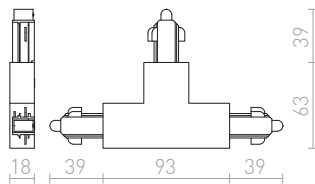

### T JUNTA (POLARIDADE DIREITA)

Ligação T com fonte de alimentação para calhas monofásicas. Carga máxima 16A.

230 V		
<b>R12275</b> branco		<b>€ 12.50</b>
<b>R12276</b> preto		<b>€ 13</b>
<b>R12277</b> cinzento prata		<b>€ 13</b>

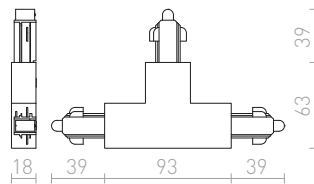

### 2M

#### SUSPENSÃO DE FIO

Gancho encaixado para calhas monofásicas.

<b>R12296</b> branco		<b>€ 8.25</b>
<b>R12297</b> preto		<b>€ 8.25</b>
<b>R12298</b> cinzento prata		<b>€ 8.25</b>

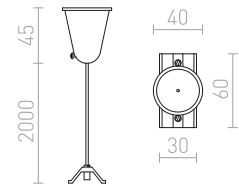

### ALIMENTAÇÃO, POLARIDADE ESQUERDA

Fonte de alimentação de terminais para calha monofásica. Carga máxima 16A.

230 V		
<b>R12284</b> branco		<b>€ 5.20</b>
<b>R12285</b> preto		<b>€ 5.20</b>
<b>R12286</b> cinzento prata		<b>€ 5.20</b>

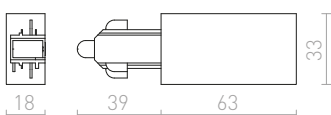

### ALIMENTAÇÃO, POLARIDADE DIREITA

Fonte de alimentação de terminais para calha monofásica. Carga máxima 16A.

230 V		
<b>R12287</b> branco		<b>€ 5.20</b>
<b>R12288</b> preto		<b>€ 5.20</b>
<b>R12289</b> cinzento prata		<b>€ 5.20</b>

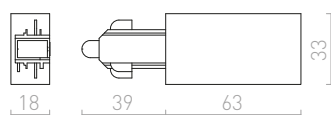

### TERMINAL

Terminais para calha monofásica.

<b>R12290</b> branco		<b>€ 1.35</b>
<b>R12291</b> preto		<b>€ 1.35</b>
<b>R12292</b> cinzento prata		<b>€ 1.35</b>

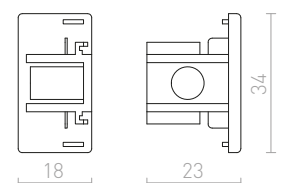



## FOCUS

Foco em forma de tubo regulável para calha monofásica com a capacidade de alterar o ângulo do feixe entre 10 - 60° com o chamado sistema Zoom. Também pode alterar a temperatura de cor da luz entre 3000K, 4000K, 5000K com um interruptor localizado na parte de trás da luz. Regulação da intensidade da luz TRIAC.

### FOCUS 12 DIMM PARA CALHA MONOFÁSICA

230 V LED 12 W  $\angle$ 10-60° 3000 K 4000 K 5000 K  
780 lm Ra 80

**R13878** branco

€ 88 NEW

**R13879** preto

€ 88 NEW

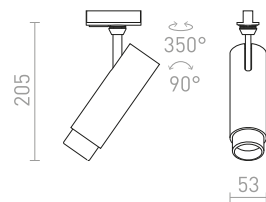

### FOCUS 20 DIMM PARA CALHA MONOFÁSICA

230 V LED 20 W  $\angle$ 10-60° 3000 K 4000 K 5000 K  
1540 lm Ra 80

**R13880** branco

€ 120 NEW

**R13881** preto

€ 120 NEW

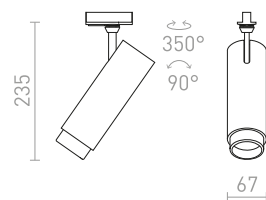



## OPTIMUS

Foco cilíndrico para calha monofásica com possibilidade de ajuste do cone de luz mediante sistema de zoom 10-50°. A luminária é adequada para fontes de luz LED com casquilho GU10. Use fontes de luz com um ângulo de feixe de 120° na luminária para evitar sombras indesejadas.

### OPTIMUS PARA CALHA MONOFÁSICA

230 V LED GU10 9 W  $\angle$ 10-50°

**R13781** branco

€ 58

**R13782** preto

€ 58



G12232

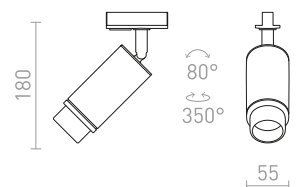





## MAVRO

Foco cilíndrico com LED integrado para calhas monofásicas. TRIAC com regulação da intensidade da luz.

### MAVRO DIMM PARA CALHA MONOFÁSICA

230 V LED 12 W  $\angle 38^\circ$  3000 K 1020 lm Ra 80

R13163 preto/ouro

€ 150

R13446 branco

€ 150

R13849 ouro

€ 150

NEW

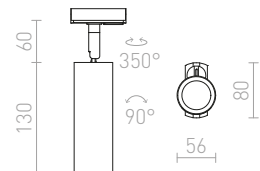

## MAVRO

Foco cilíndrico com LED integrado para calhas monofásicas.

### MAVRO PARA CALHA MONOFÁSICA

230 V LED 12 W  $\angle 38^\circ$  3000 K 1020 lm Ra 80

R12993 branco

€ 120

R12994 preto/ouro

€ 120

R13848 ouro

€ 120

NEW

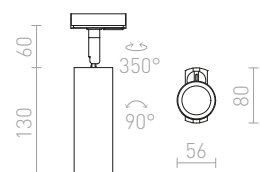



## WISH

Luminária cilíndrica regulável para calha monofásica ajustável de cor clara: branco quente (WW), branco neutro (NW), branco frio (CW). Regulação da intensidade da luz TRIAC.

### WISH 20 DIMM PARA CALHA MONOFÁSICA

230 V LED 20 W  $\angle 36^\circ$  3000 K 4000 K 5000 K  
1600 lm Ra 80

R13769 branco

€ 98

NEW

R13770 preto

€ 98

NEW

LED

regulável

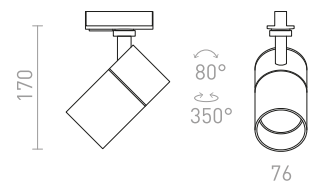

### WISH 30 DIMM PARA CALHA MONOFÁSICA

230 V LED 30 W  $\angle 36^\circ$  3000 K 4000 K 5000 K  
2400 lm Ra 80

R13771 branco

€ 120

NEW

R13772 preto

€ 120

NEW

LED

regulável

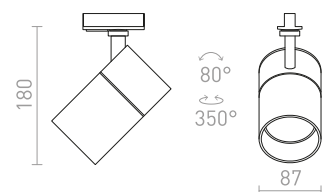



## DUDE

Foco cilíndrico com casquilho GU10 para fontes de luz LED e adaptador para calha monofásica.

### DUDE PARA CALHA MONOFÁSICA

230 V LED GU10 9 W

R13926 branco

€ 58 NEW

R13927 preto

€ 58 NEW

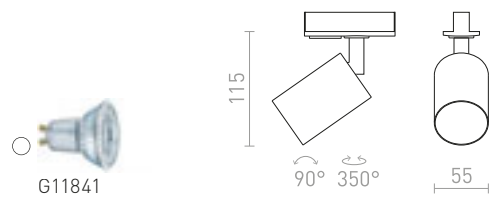

## BELENOS

Foco cilíndrico minimalista com casquilho GU10 para calhas monofásicas. As molas ligadas ao casquilho permitem o uso de fontes de luz de vários comprimentos.

### BELENOS PARA CALHA MONOFÁSICA

230 V LED GU10 9 W

R13367 branco

€ 68

R13369 preto

€ 68

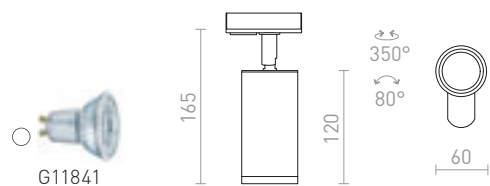



## FORZA

Foco cilíndrico com casquilho GU10 para calhas monofásicas.

### FORZA PARA CALHA MONOFÁSICA

230 V LED GU10 10 W

R13350 branco

€ 78

R13351 preto

€ 78

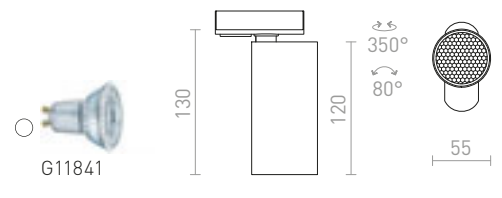

## CADENZA

Foco cilíndrico com casquilho GU10 para calhas monofásicas.

### CADENZA PARA CALHA MONOFÁSICA

230 V LED GU10 10 W

R13346 branco

€ 68

R13347 preto

€ 68

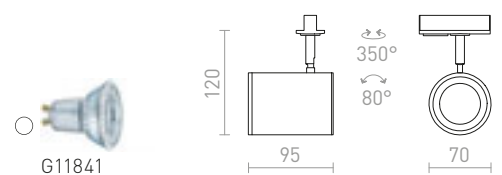



## DARIO

Foco cilíndrico com casquilho GU10 para fontes de luz LED, incluindo um tom decorativo de latão preto escovado. Diferentes combinações de cores estão disponíveis comprando tons adicionais em outras cores. Para uso com calhas monofásicas.

### DARIO PARA CALHA MONOFÁSICA

230 V GU10 9 W

**R13870** branco/latão escovado

€ 78 NEW

**R13871** preto/latão escovado

€ 78 NEW

**R13872** latão escovado

€ 88 NEW

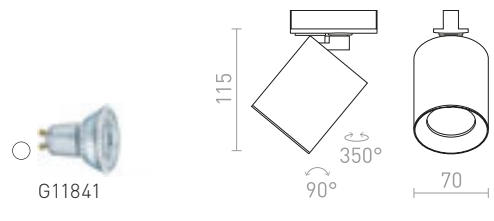
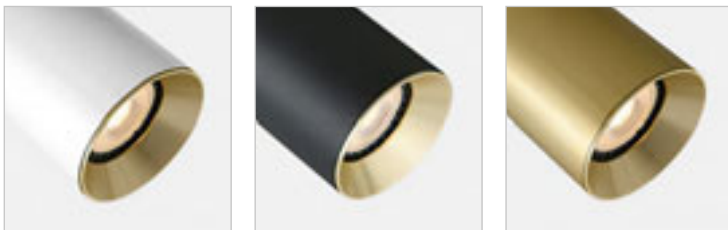

## DARIO

Tonalidade decorativa interna de metal em várias cores para a luz DARIO.

### DARIO ANEL DECORATIVO

**R13876** branco

€ 8.50 NEW

**R13877** preto

€ 8.50 NEW

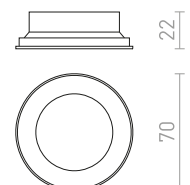
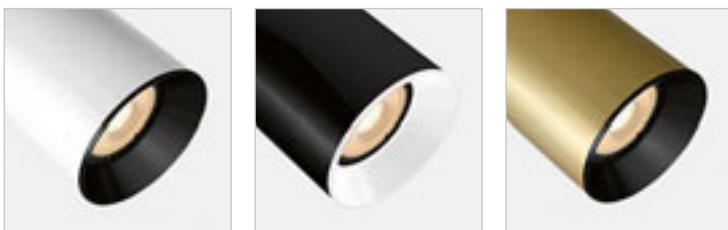



## CONNOR

Foco cilíndrico com casquilho GU10 para calhas monofásicas.

### CONNOR PARA CALHA MONOFÁSICA

230 V LED GU10 10 W

R13497 branco/preto

€ 58

R13498 preto/ouro

€ 58

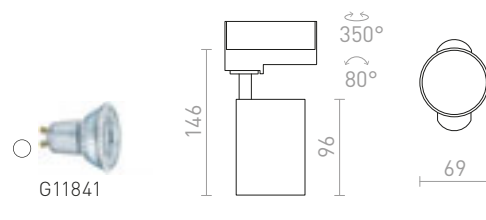

## SIENA

Foco para calha monofásica disponível em duas cores para fontes de luz com casquilho GU10.

### SIENA PARA CALHA MONOFÁSICA

230 V GU10 50 W

R13759 branco

€ 78

NEW

R13760 preto

€ 78

NEW

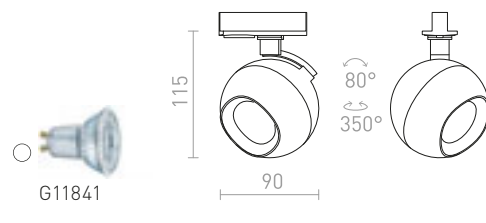

## LALA

Foco cilíndrico para calha monofásica para fontes de luz com casquilho GU10.

### LALA PARA CALHA MONOFÁSICA

230 V GU10 50 W

R13767 preto/latão

€ 58

NEW

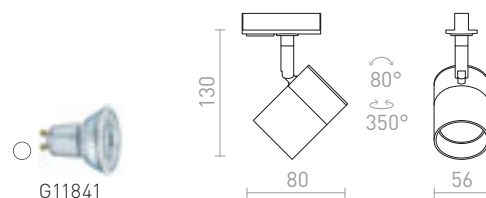



## BEEBA

Foco para calhas monofásicas disponível em dois cores.

### BEEBA I PARA CALHA MONOFÁSICA

230 V GU10 35 W

R12308 branco

€ 58

R12310 preto

€ 58

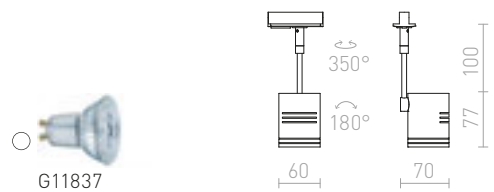

### BEEBA II PARA CALHA MONOFÁSICA

230 V GU10 2x35 W

R12314 branco

€ 88

R12316 preto

€ 88

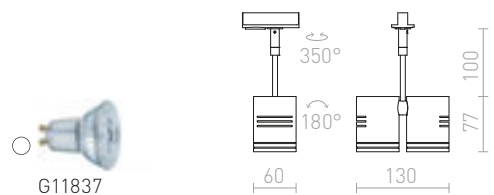



## PURINA

Foco para calhas monofásicas com casquilho GU10 em três cores. Inclui um anel decorativo para fontes de luz com diâmetro de refletor de 51 mm. Fontes de luz ES111 também podem ser usadas nesta luminária.

### PURINA PARA CALHA MONOFÁSICA

230 V GU10 50 W

<b>R12320</b> branco	€ 48	▶
<b>R12321</b> cinzento prata	€ 32	▶
<b>R12322</b> preto	€ 48	▶



G11841

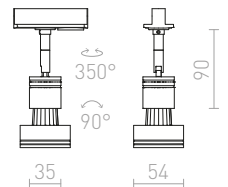

## TRICA

Foco com casquilho GU10 para calhas monofásicas. Podem ser usadas fontes de luz com 111 e 51 mm de diâmetro. Todas as medidas são especificadas sem fonte de luz.

### TRICA PARA CALHA MONOFÁSICA

230 V GU10 50 W

<b>R12977</b> branco	€ 29
<b>R12978</b> preto	€ 29



G12723

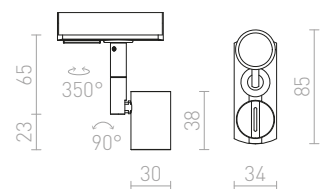





## COPA

Luminária suspensa com abajur de vidro para calha monofásica. Disponível em duas cores.

### COPA PARA CALHA MONOFÁSICA

230 V E27 28 W

**R13205** vidro colorido opala

€ 178

**R13206** preto/vidro

€ 188

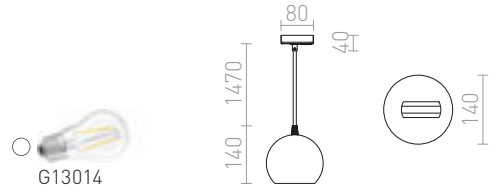

## LUNA

Pendente em vidro de cor opalina com detalhes em cromado e um cabo transparente que está ligado a um adaptador para calha monofásica.

### LUNA 20 PARA CALHA MONOFÁSICA

230 V LED E27 15 W

**R13964** vidro colorido opala/cromo

€ 120

NEW

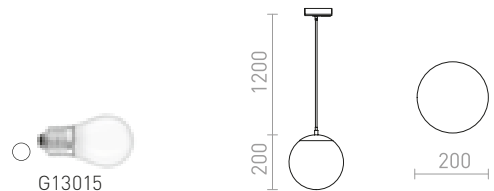

### LUNA 25 PARA CALHA MONOFÁSICA

230 V LED E27 15 W

**R13965** vidro colorido opala/cromo

€ 178

NEW

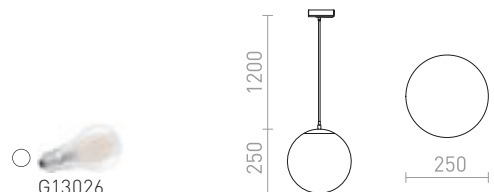

### LUNA 30 PARA CALHA MONOFÁSICA

230 V E27 15 W

**R13966** vidro colorido opala/cromo

€ 215

NEW

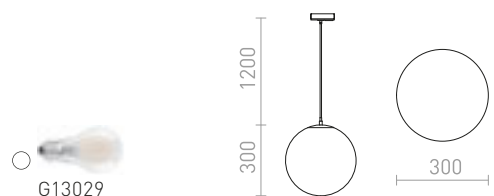





## ARAQ

Pendente com casquilho de latão, cabo têxtil e adaptador para calha monofásica. Adequado para lâmpadas decorativas E27.

### ARAQ PARA CALHA MONOFÁSICA SUSPENSO

230 V E27 42 W

R13978 latão escovado/preto

€ 48 **NEW**

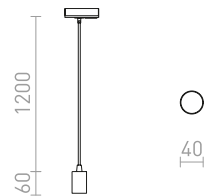

## BELLINI

Luminária suspensa de vidro com acessórios lacados para casquilho LED E14. O cabo é ligado a um adaptador para calhas monofásicas.

### BELLINI L E14 PARA CALHA MONOFÁSICA SUSPENSO

230 V E14 15 W

R13963 branco/vidro transparente

€ 188 **NEW**

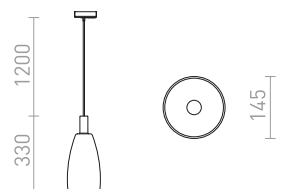



## PULIRE

Candeeiro suspenso estilo retro feito em vidro tingido e com adaptador para calha monofásica.

### PULIRE CON PARA CALHA MONOFÁSICA

230 V E14 28 W

R13209 vidro colorido opala/madeira

€ 120



G11849

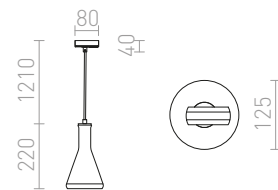

### PULIRE RD PARA CALHA MONOFÁSICA

230 V E14 28 W

R13210 vidro colorido opala/madeira

€ 120



G11849

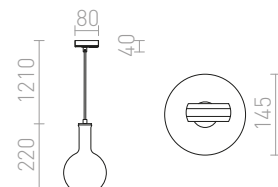



## JULIETTA

Luminária suspensa com um abajur cilíndrico de cor opala, detalhes em metal lacado, cabo têxtil preto e adaptador para calhas monofásicas.

### JULIETTA 16 PARA CALHA MONOFÁSICA

230 V E27 20 W

**R13860** vidro colorido opala/preto

**€ 129**

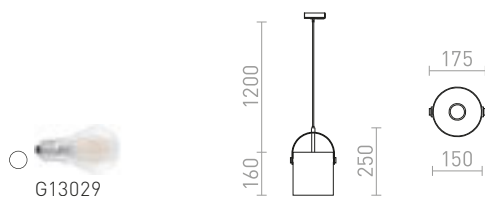

### JULIETTA 31 PARA CALHA MONOFÁSICA

230 V E27 20 W

**R13861** vidro colorido opala/preto

**€ 178**

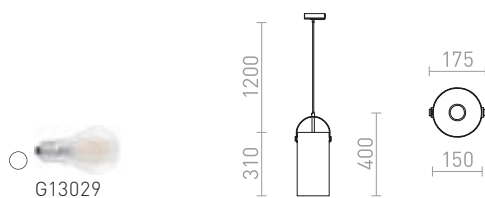



## GIULIA

Candeeiro suspenso com um abajur em metal lacado e um cabo têxtil. O cabo está ligado a um adaptador para calha monofásica.

### GIULIA 12 PARA CALHA MONOFÁSICA

230 V E27 40 W

**R13986** branco/cromo

€ 68

NEW

**R13987** preto/castanho dourado/latão

€ 68

NEW

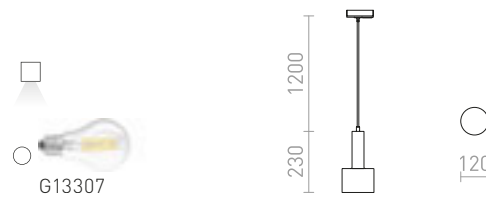

### GIULIA 20 PARA CALHA MONOFÁSICA

230 V E27 40 W

**R13988** branco/cromo

€ 78

NEW

**R13989** preto/castanho dourado/latão

€ 88

NEW

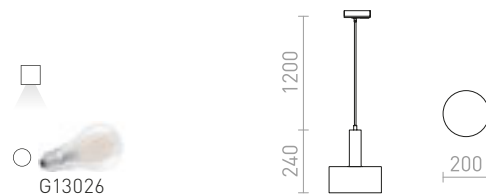



## CHOUPETTE

Luminária suspensa em tecido com acessório em madeira para fonte de luz LED com casquinho E27 para instalação em calha monofásica.

### CHOUPETTE PARA CALHA MONOFÁSICA

230 V E27 15 W

R13720 cinzento escuro/têxtil/madeira

€ 129

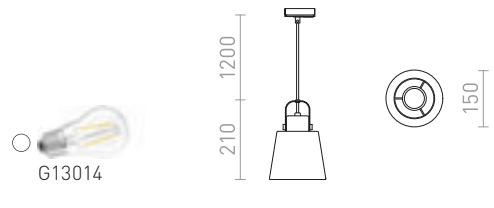

## BABADES

Luminária suspensa com abajur e base de teto em cromo ou níquel mate. Cabo têxtil preto com adaptador para calhas monofásicas.

### BABADES PARA CALHA MONOFÁSICA

230 V GU10 35 W

R13212 cromo

€ 68

R13213 níquel mate

€ 68

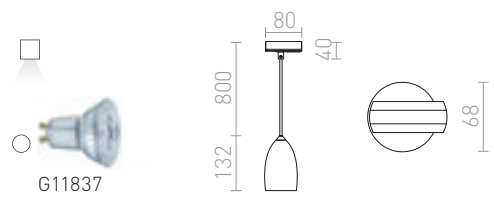

## ICAR

Candeeiro suspenso minimalista com abajur têxtil. Cabo têxtil preto com adaptador para calha monofásica.

### ICAR PARA CALHA MONOFÁSICA

230 V E27 15 W

R13214 preto/ouro

€ 120 →

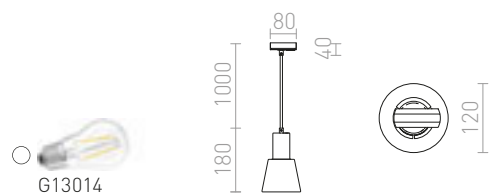



## MAVRO

LED elegante pendente em forma de tubo, adequado para balcões de bar ou ilhas de cozinha. O cabo está ligado a um adaptador para calha monofásica.

### MAVRO PARA CALHA MONOFÁSICA SUSPENSO

230 V LED 12 W  $\angle 38^\circ$  3000 K 1020 lm Ra 80

R13980 branco

€ 120

NEW

R13981 ouro

€ 120

NEW

R13982 preto/ouro

€ 120

NEW

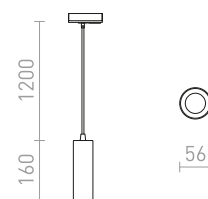

## BELENOS

Luminária suspensa cilíndrica minimalista para fontes de luz GU10 numa base redonda. Molas presas à tomada permitem o uso de fontes de luz de vários comprimentos. O cabo é ligado a um adaptador para calhas monofásicas.

### BELENOS SUSPENSA PARA CALHA MONOFÁSICA

230 V LED GU10 9 W

R13862 branco

€ 68

R13863 preto

€ 68



G11841

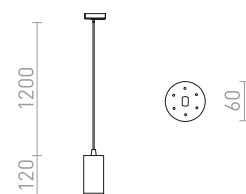





## AGNETA

Pendente redondo em metal para utilização com uma fonte de luz E27 adequada. O cabo está ligado a um adaptador para calha monofásica.

### AGNETA PARA CALHA MONOFÁSICA SUSPENSO

230 V E27 40 W

**R13970** branco

€ 68

NEW

**R13971** preto

€ 68

NEW

**R13972** latão escovado

€ 98

NEW

**R13973** cobre escovado

€ 98

NEW

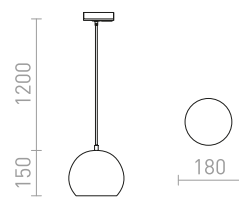



## DESTY

Luminária suspensa com abajur metálico para calha monofásica.

### DESTY PARA CALHA MONOFÁSICA

230 V GU10 35 W

R13211 preto/cromo

€ 88

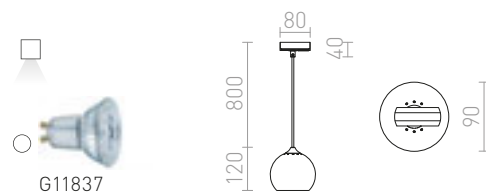

## BLONDIE

Luminária suspensa com um abajur em metal amassado. A parte externa do abajur tem cor de cobre e a parte interna é lacada a branco. Fornecido com um cabo de PVC preto com adaptador para calhas monofásicas.

### BLONDIE 25 PARA CALHA MONOFÁSICA

230 V E27 42 W

R13726 cobre

€ 215

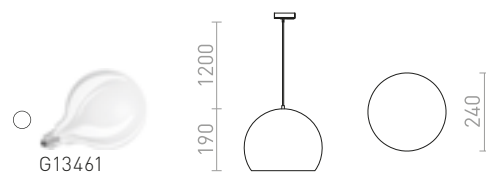

## ELISA

Cabo têxtil em varias cores e combinações com casquilho metálico E27 e com adaptador para calha monofásica. Usar com fonte de luz decorativa ou com abajur disponível.

### ELISA PARA CALHA MONOFÁSICA

230 V E27 28 W

R13201

€ 58

R13202

€ 58

R13203

€ 58

R13204

€ 68

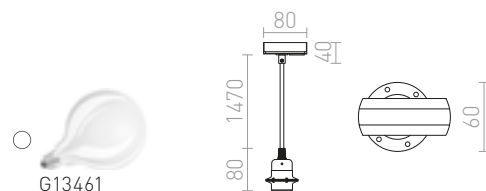

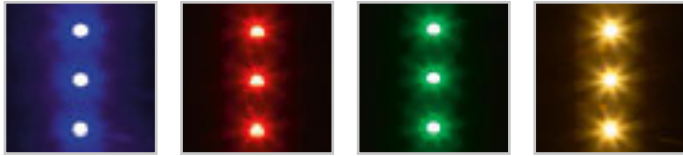

## LED STRIP LED ORION

Fita de LED RGBW que pode ser configurada para cores diferentes ou branca com várias temperaturas de cor (3000K - 450lm/m). Vem num comprimento de 5 m que pode ser cortado a cada 5 cm, e possui uma fita dupla face na parte de trás da fita. Driver e controlador de LED adequados precisam de ser adicionados e são vendidos separadamente. Recomendamos adquirir o nosso controlador G13804, que é testado e verificado e permite o controlo da faixa de LED por controlo remoto (incluído no pacote G13804), pelo uso do Amazon Alexa, Google Assistant ou com aplicativos como Smart Life e Tuya Smart.

### LED STRIP ORION RGBW FITA LED 5M

12V= LED 96 W  $\angle 120^\circ$  RGBW up to 2250 lm Ra 80

G13820

€ 58



LED

5000x12 mm

## LED STRIP LED ORION

Fita de LED RGB com capacidade de mudar de cor que vem em comprimentos de 5m que podem ser cortados a cada cinco cm. A fita tem uma fita dupla face na parte de trás. Driver e controlador de LED adequados precisam de ser adicionados e são vendidos separadamente. Recomendamos adquirir o nosso controlador G13804, que é testado e verificado e permite o controlo da faixa de LED por controlo remoto (incluído no pacote G13804), pelo uso do Amazon Alexa, Google Assistant ou com aplicativos, tais como Smart Life e Tuya Smart.

### LED STRIP ORION RGB FITA LED 5M

12V= LED 72 W  $\angle 120^\circ$  RGB 2250 lm Ra 80

G13800

€ 38 →



LED

5000x10 mm



## LED STRIP ORION CONTROLADOR WIFI 5 EM 1

Driver wi-fi 5 em 1. As fitas de LED podem ser controladas usando os aplicativos Amazon Alexa, Google Assistant ou Smart Life ou Tuya Smart. A unidade de controlo opera apenas na frequência de 2,4 GHz. O pack inclui um controlo remoto separado. O controlador Wi-fi pode ser usado para controlar as fitas de LED RGB ou escurecer as fitas de LED monocromáticas G13798, G13799.

G13804

€ 24



**LED STRIP ORION 60 DRIVER**

Driver LED 60W 12V para alimentar fitas de LED.

230 V/12 V= 60 W IP67

**G13801**

**€ 22**



25x202x35 mm



**LED STRIP ORION 100 DRIVER**

Driver LED 100W 12V para alimentar fitas de LED.

230 V/12 V= 100 W IP67

**G13802**

**€ 29**



35x178x53 mm



**LED STRIP ORION 150 DRIVER**

Driver LED 150W 12V para alimentar fitas de LED.

O driver possui terminais secundários.

230 V/12 V= 150 W IP67

**G13803**

**€ 48**



33x199x61 mm

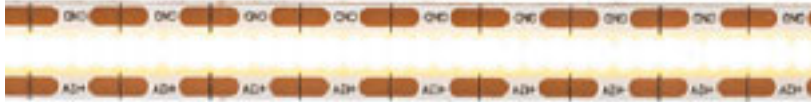

### LED STRIP LED ORION

Fita LED COB com alto rendimento. A fita tem uma luz uniforme em toda a sua extensão, sem manchas visíveis. Fornecido em comprimentos de 5m que podem ser cortados a cada 0,75 cm e possui fita dupla face na parte de trás. O driver adequado precisa de ser adicionado e é vendido separadamente. A faixa pode ser regulada usando o controlo remoto G13804. 3000K - 950lm/m; 4000K - 1000lm/m

#### LED STRIP ORION FITA LED 5M

12V= LED 50 W  $\angle 120^\circ$  3000 K 2375 lm Ra 80

G13798

€ 58



5000x8 mm

#### LED STRIP ORION FITA LED 5M

12V= LED 50 W  $\angle 120^\circ$  4000 K 2500 lm Ra 80

G13799

€ 58



5000x8 mm

### LED STRIP ORION CONTROLADOR WIFI 5 EM 1

Driver wi-fi 5 em 1. As fitas de LED podem ser controladas usando os aplicativos Amazon Alexa, Google Assistant ou Smart Life ou Tuya Smart. A unidade de controlo opera apenas na frequência de 2,4 GHz. O pack inclui um controlo remoto separado. O controlador Wi-fi pode ser usado para controlar as fitas de LED RGB ou escurecer as fitas de LED monocromáticas G13798, G13799.

G13804

€ 24



**LED STRIP ORION 60 DRIVER**

Driver LED 60W 12V para alimentar fitas de LED.

230 V/12 V= 60 W IP67

**G13801**

**€ 22**



25x202x35 mm



**LED STRIP ORION 100 DRIVER**

Driver LED 100W 12V para alimentar fitas de LED.

230 V/12 V= 100 W IP67

**G13802**

**€ 29**



35x178x53 mm



**LED STRIP ORION 150 DRIVER**

Driver LED 150W 12V para alimentar fitas de LED.

O driver possui terminais secundários.

230 V/12 V= 150 W IP67

**G13803**

**€ 48**



33x199x61 mm



### LED STRIP IP20 5M

Fita LED adequada para iluminação interior decorativa. Fornecida em embalagem de 5 metros, divisível a cada 5 cm, com uma fita adesiva com nervuras nas costas. A fita está disponível em versões de luz quente ou fria. Precisa de um driver e conector (vendidos separadamente).

12 V= LED 60 W 5000 lm Ra 80

**G12366** 3000 K

**€ 14**

**G12367** 4000 K

**€ 14**



G13802



5000x8 mm



### LED STRIP IP20 FONTE DE ENERGIA

Acessórios para LED STRIP IP20 G12366 e G12367.

**G12370**

**€ 0.50**



150 mm

### LED STRIP IP20 LIGAÇÃO

Acessórios para LED STRIP IP20 G12366 e G12367.

**G12368**

**€ 0.80**



165 mm

### LED STRIP IP20 LIGAÇÃO DIRETA

Acessórios para LED STRIP IP20 G12366 e G12367.

**G12369**

**€ 0.40**



5x16x13 mm

### LED STRIP FONTE DE ENERGIA

Fonte de alimentação para fitas LED 12V =, 230 V/12V= 72 W

**G12377**

**€ 22**



42x100x160 mm



**LED STRIP IP54 5M**

Fita LED adequada para iluminação decorativa em ambientes húmidos. Fornecida em uma embalagem de 5 metros, divisível a cada 5 cm, com uma fita adesiva com nervuras nas costas. A fita está disponível em versões de luz quente ou fria. Precisa de um driver e conector.

12 V= LED 60 W 5000lm Ra 80 IP54

- G12371** 3000 K **€ 24**
- G12372** 4000 K **€ 24**

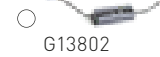

G13802



5000x8 mm

**LED STRIP IP54 FONTE DE ENERGIA**

Acessórios para LED STRIP IP54 G12371 e G12372.

- G12375** **€ 0.70**



150 mm

**LED STRIP IP54 LIGAÇÃO**

Acessórios para LED STRIP IP54 G12371 e G12372.

- G12373** **€ 1.20**



165 mm

**LED STRIP IP54 LIGAÇÃO DIRETA**

Acessórios para LED STRIP IP54 G12371 e G12372.

- G12374** **€ 0.50**



8x15x14 mm



**IP54**

**LED STRIP REGULADOR DA INTENSIDADE DA LUZ COM CONTROLO REMOTO**

Controlo remoto para fita LED 12V = intensidade de luz ajustável. Adequado para fitas LED G12366, G12367, G12371 ou G12372.

12 V= max. 108 W

- G12378** branco **€ 48**



G13802

103x54x6 mm





## LED PROFIL

Um perfil de alumínio montado à superfície para colocação de uma fita LED adequada. Fornecido com um difusor mate e acessórios.

### LED PROFILE G MONTAGEM EM SUPERFÍCIE 1M

<b>R14086</b> branco/acrílico fosco/alumínio	<b>€ 24</b>	NEW
<b>R14087</b> preto/acrílico fosco/alumínio	<b>€ 24</b>	NEW
<b>R14088</b> alumínio anodizado/acrílico fosco	<b>€ 18</b>	NEW

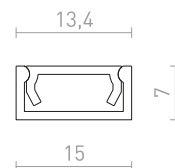

## LED PROFIL

Um perfil de alumínio montado à superfície para colocação de uma fita LED adequada. Fornecido com um difusor mate e acessórios.

### LED PROFILE H MONTAGEM EM SUPERFÍCIE 1M

<b>R14089</b> branco/acrílico fosco/alumínio	<b>€ 35</b>	NEW
<b>R14090</b> preto/acrílico fosco/alumínio	<b>€ 35</b>	NEW
<b>R14091</b> alumínio anodizado/acrílico fosco	<b>€ 29</b>	NEW

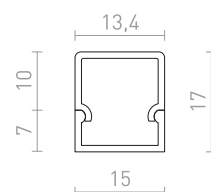

## LED PROFIL

Um perfil de alumínio assimétrico de canto para colocar uma fita LED adequada. Consoante o modo de montagem, a luz sairá num ângulo de 30° ou 60°. Fornecido com um difusor mate e acessórios.

### LED PROFILE I 30/60 MONTAGEM EM SUPERFÍCIE 1M

<b>R14092</b> alumínio anodizado/acrílico fosco	<b>€ 26</b>	NEW
---	-------------	-----

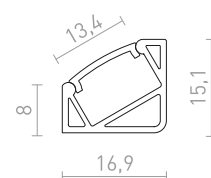



## LED PROFIL

Um perfil de alumínio de canto para a colocação de tiras de LED adequadas. Podem ser colocadas no perfil até três tiras de LED de 8 mm de largura ou duas tiras de LED de 12 mm de largura. Fornecido com um difusor mate e acessórios.

### LED PROFILE J MONTAGEM EM SUPERFÍCIE 1M

<b>R14093</b> branco/acrílico fosco/alumínio	€ 120	NEW
<b>R14094</b> preto/acrílico fosco/alumínio	€ 120	NEW
<b>R14095</b> alumínio anodizado/acrílico fosco	€ 98	NEW

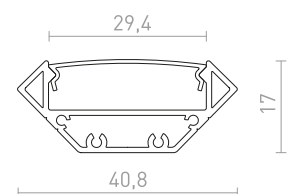



## LED PROFIL

Perfil de alumínio para uso com fita de LED adequada. Inclui um difusor fosco e acessórios.

### LED PROFILE A EMBUTIDA 1M

R13864 alumínio/acrílico fosco

€ 26

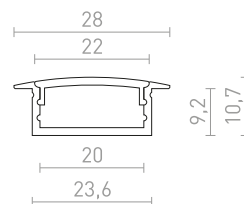

↑ 9  
 1000x24



## LED PROFIL

Perfil de alumínio para uso com fita de LED adequada. Inclui um difusor fosco e acessórios. Adequado para embutir na parede de gesso.

### LED PROFILE B EMBUTIDA 1M

R13865 alumínio/acrílico fosco

€ 48

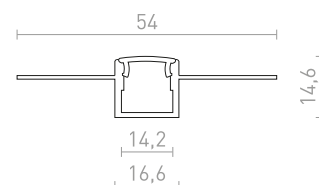

↑ 14  
 1000x17





## LED PROFIL

Perfil de alumínio para uso com fita de LED adequada. Inclui um difusor fosco e acessórios.

**LED PROFILE D MONTAGEM EM SUPERFÍCIE 1M**

**R13866** alumínio/acrílico fosco

**€ 32**

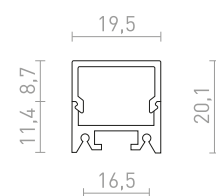



## ABAJURES E ACESSÓRIOS

ABAJURES SUSPENSOS	572-573
ABAJURES DE MESA/DE PÉ	574-577
ABAJURES UNIVERSAIS	578-593
CONJUNTO DE SUSPENSÃO	594-607
SUPORTES E BASES	608-617
CABOS	618-619



## ABAJURES E ACESSÓRIOS ABAJURES SUSPENSOS



**ASPRO 40/30**  
572-573



**ASPRO 55/30**  
572-573



**DAISY**  
572-573

572-573



**BEAT 38**  
572-573

## ABAJURES E ACESSÓRIOS ABAJURES DE MESA/DE PÉ

574-577



**CONNYP 15/15**  
574-575



**CONNYP 15/30**  
574-575



**CONNYP 25/30**  
574-575



**CONNYP 35/30**  
574-575



**ALVIS 24/15**  
576-577



**AMBITUS 30/21**  
576-577



**AMBITUS 46/24**  
576-577



**NIZZA 18/15**  
576-577

## ABAJURES E ACESSÓRIOS ABAJURES UNIVERSAIS

578-593



**RIDICK**  
578-579



**ILLUSION 45/33**  
578-579



**JAKARANDA 40**  
578-579



**DELISA 25/16**  
580-581



**DELISA 35/30**  
580-581



**RON 60/19**  
582-583



**RON 55/30**  
582-583



**RON 15/20**  
584-585



**RON 40/25**  
584-585



**DOUBLE 40/30**  
586-587



**DOUBLE 55/30**  
586-587



**TEMPO 30/19**  
588-589





**TEMPO 50/19**  
588-589



**TEMPO 15/15**  
590-591



**TEMPO 15/30**  
590-591



**CASUAL 90/22**  
590-591



**CASUAL 120/25**  
590-591



**LOPE 80/23**  
592-593



**LOPE 120/22**  
592-593

## ABAJURES E ACESSÓRIOS CONJUNTO DE SUSPENSÃO



**MORE 60**  
594-595

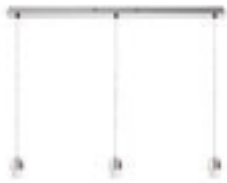

**MORE 80**  
594-595



**RALLONG IV**  
594-595



**RALLONG IV**  
594-595



**RALLONG V**  
594-595



**RALLONG V**  
594-595



**KOMBIX 2**  
596-597



**KOMBIX 3**  
596-597



**KOMBIX 6**  
596-597



**HEX**  
598-599



**ELISA**  
600-601



**FABIO**  
602-603



**LISA**  
602-603



**ENZO**  
602-603



**SOLO SQ**  
604-605



**SOLO R**  
604-605



**POSTE**  
604-605



**TRIX**  
604-605



**SPIDER I**  
606-607

## ABAJURES E ACESSÓRIOS SUPORTES E BASES

608-617



**BEND**  
608-609



**HUDSON**  
608-609



**WOODY**  
610-611



**NIZZA 18/15**  
610-611



**NIZZA**  
610-611



**AMBITUS**  
612-613



**AMBITUS**  
612-613



**ALVIS**  
612-613



**ALVIS**  
612-613



**KEITH**  
614-615



**MAUI**  
614-615



**LUTON**  
614-615



**NYC TRIPOD**  
614-615



**NYC**  
616-617



**NYC**  
616-617



**CORTINA**  
616-617



**CORTINA**  
616-617

## ABAJURES E ACESSÓRIOS CABOS

618-619



**FIT 3x0,75 4m**  
618-619



**FIT 3x0,75**  
618-619



**FIT 3x0,75**  
618-619

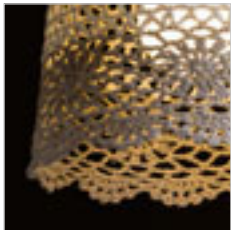
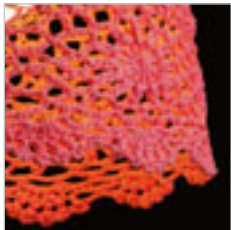

## DAISY

Abajur suspenso de malha. Acessórios adequados: ELISA, ENZO, HEX, LISA.

### DAISY ABAJUR SUSPENSO

max. 15 W

R13278 rosa

€ 29 %

R13279 branco/cinza claro

€ 29 %

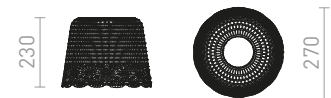

## BEAT

Abajur acolchoado sólido de imitação de couro.

### BEAT 38 ABAJUR SUSPENSO

max. 28 W

R13281 preto

€ 48 %



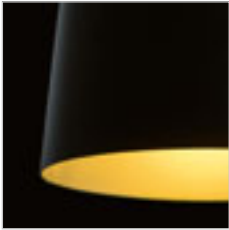

## ASPRO

Abajur decorativo de folha de cromo, que pode ser combinado com um conjunto suspenso ou uma base de candeeiro de pé. Quando a lâmpada está acesa, ela se torna semi-transparente e, quando desligada, possui uma superfície refletora. Acessórios adequados

### ASPRO 55/30 ABAJUR

max 23 W

	<b>R11466</b> Poli-algodão preto/folha dourada	€ 248
	<b>R11482</b> Poli-algodão preto/folha de cobre	€ 248
	<b>R11494</b> Poli-algodão branco/PVC branco	€ 120
	<b>R11577</b> monaco gasolina azul/prata PVC	€ 229
	<b>R11588</b> monaco pomba gris/prata PVC	€ 229

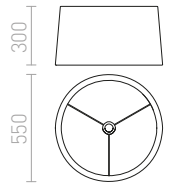

## ASPRO

Abajur têxtil para casquilho E27. Adequado para instalação em conjunto de suspensão. O difusor PMMA (R11867) pode ser encomendado para o abajur. Acessórios adequados: HEX, ELISA, ENZO, KOMBIX, LISA, POSTE, TRIX.

### ASPRO 40/30 ABAJUR

max 23 W

	<b>R11467</b> Poli-algodão preto/folha dourada	€ 178
	<b>R11483</b> Poli-algodão preto/folha de cobre	€ 178
	<b>R11495</b> Poli-algodão branco/PVC branco	€ 120
	<b>R11578</b> monaco gasolina azul/prata PVC	€ 188
	<b>R11589</b> monaco pomba gris/prata PVC	€ 188

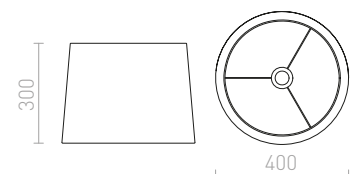



## CONNY

Abajur têxtil para uso com candeeiros de mesa com casquilho E27. Acessórios adequados: CORTINA, NYC, NYC TRIPOD, WOODY.

### CONNY 25/30 ABAJURES DE MESA

max. 23 W

	<b>R11371</b> Poli-algodão preto/folha de cobre	€ 129
	<b>R11497</b> Poli-algodão branco/PVC branco	€ 68
	<b>R11580</b> monaco gasolina azul/prata PVC	€ 120
	<b>R11591</b> monaco pomba gris/prata PVC	€ 120
	<b>R11597</b> Poli-algodão preto/folha dourada	€ 129

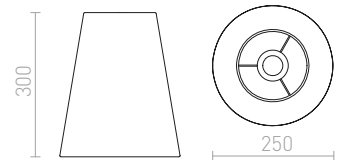

## CONNY

Abajur têxtil para casquilho E27 para vários suportes de chão. Acessórios adequados: ALVIS, AMBITUS, CORTINA, NYC, NYC TRIPOD, WOODY.

### CONNY 35/30 ABAJUR

max. 23 W

	<b>R11372</b> Poli-algodão preto/folha de cobre	€ 178
	<b>R11469</b> Poli-algodão preto/folha dourada	€ 178
	<b>R11498</b> Poli-algodão branco/PVC branco	€ 88
	<b>R11581</b> monaco gasolina azul/prata PVC	€ 178
	<b>R11592</b> monaco pomba gris/prata PVC	€ 178

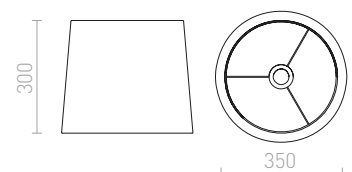



## CONNY

Abajur têxtil para casquilho E27. Adequado para uso com suporte de candeeiro de mesa. Acessórios adequados: ALVIS, AMBITUS, CORTINA, NYC.

### CONNY 15/15 ABAJUR

max 28 W



**R11800**

Poli-algodão branco/PVC branco

€ 68

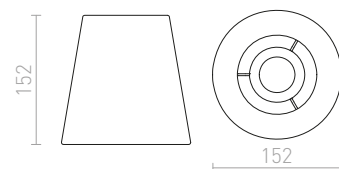

## CONNY

Abajur têxtil para uso com candeeiros de mesa E27. Acessórios adequados: CORTINA, NYC.

### CONNY 15/30 ABAJURES DE MESA

max 23 W



**R11370**

Poli-algodão preto/folha de cobre

€ 88

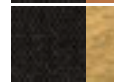

**R11468**

Poli-algodão preto/folha dourada

€ 98

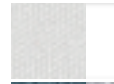

**R11496**

Poli-algodão branco/PVC branco

€ 68



**R11579**

monaco gasolina azul/prata PVC

€ 98



**R11590**

monaco pomba gris/prata PVC

€ 98

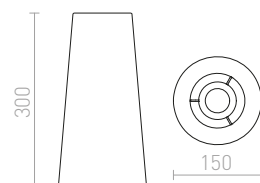



## AMBITUS

Abajur têxtil com suporte para casquilho E27, adequado para bases de candeeiros de mesa: ALVIS, AMBITUS, CORTINA, MAUI, NYC, WOODY.

**AMBITUS 30/21 ABAJUR DE MESA**  
max. 28 W

**R13841** Poli-algodão branco

**€ 68**

NEW

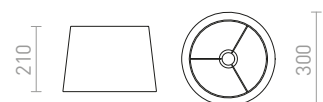



## NIZZA

Abajur têxtil para casquilho E27, adequado para instalação em conjuntos suspensos e candeeiros de mesa R12947.

### NIZZA 18/15 ABAJUR

max 28 W

**R13113** Poli-algodão branco/PVC branco

€ 58

**R13114** Poli-algodão preto/PVC branco

€ 58

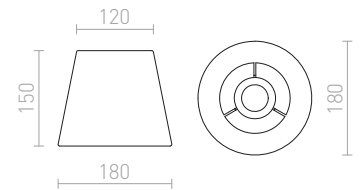

## ALVIS

Abajur têxtil para casquilho E27. Adequado para suportes de candeeiro de mesa: ALVIS, CORTINA, MAUI, NYC, MADEIRA.

### ALVIS 24/15 ABAJUR CANDEEIRO DE MESA

max 28 W

**R13524** branco creme

€ 48

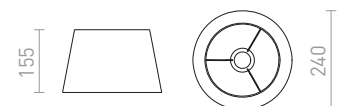

## AMBITUS

Abajur têxtil com suporte para casquilho E27, adequado para bases de candeeiros de pé: ALVIS, AMBITUS, CORTINA, MAUI, NYC.

### AMBITUS 46/24 ABAJUR CANDEEIRO DE PÉ

max 28 W

**R13526** branco creme

€ 98

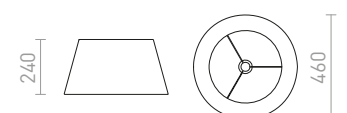





## RIDICK

Abajur decorativo preto com interior dourado, que pode ser combinado com um conjunto suspenso ou uma luminária de pé. Acessórios adequados: HEX, ELISA, ENZO, LISA, KOMBIX, BEND, ALVIS, AMBITUS, NYC.

### RIDICK ABAJUR

max. 20 W

**R13344** preto brilhante/folha dourada

€ 68 →

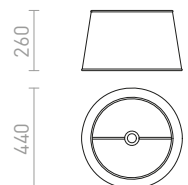

## ILLUSION

Abajur decorativo de folha de cromo, que pode ser combinado com um conjunto suspenso ou uma base de candeeiro de pé. Quando a lâmpada está acesa, ela torna-se semi-transparente e, quando desligada, possui uma superfície refletora. Acessórios adequados: HEX, ELISA, ENZO, LISA, KOMBIX, BEND, ALVIS, AMBITUS, NYC.

### ILLUSION 45/33 ABAJUR

max. 20 W

**R13417** folha de cromo

€ 98 →

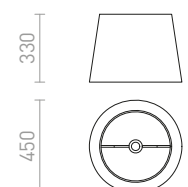



## JAKARANDA

Abajur têtil com a superfície 3D geométrica. Para uso com um conjunto suspenso ou um suporte para casquilho E27. Acessórios adequados: HEX, ELISA, ENZO, KOMBIX, LISA, AMBITUS, ALVIS, CORTINA.

### JAKARANDA 40 ABAJUR

max 28 W

R12392 branco

€ 120

R12393 preto

€ 120

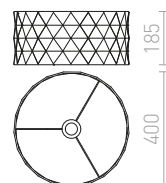



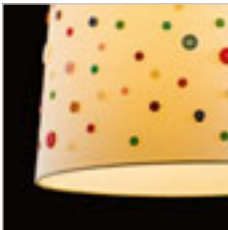
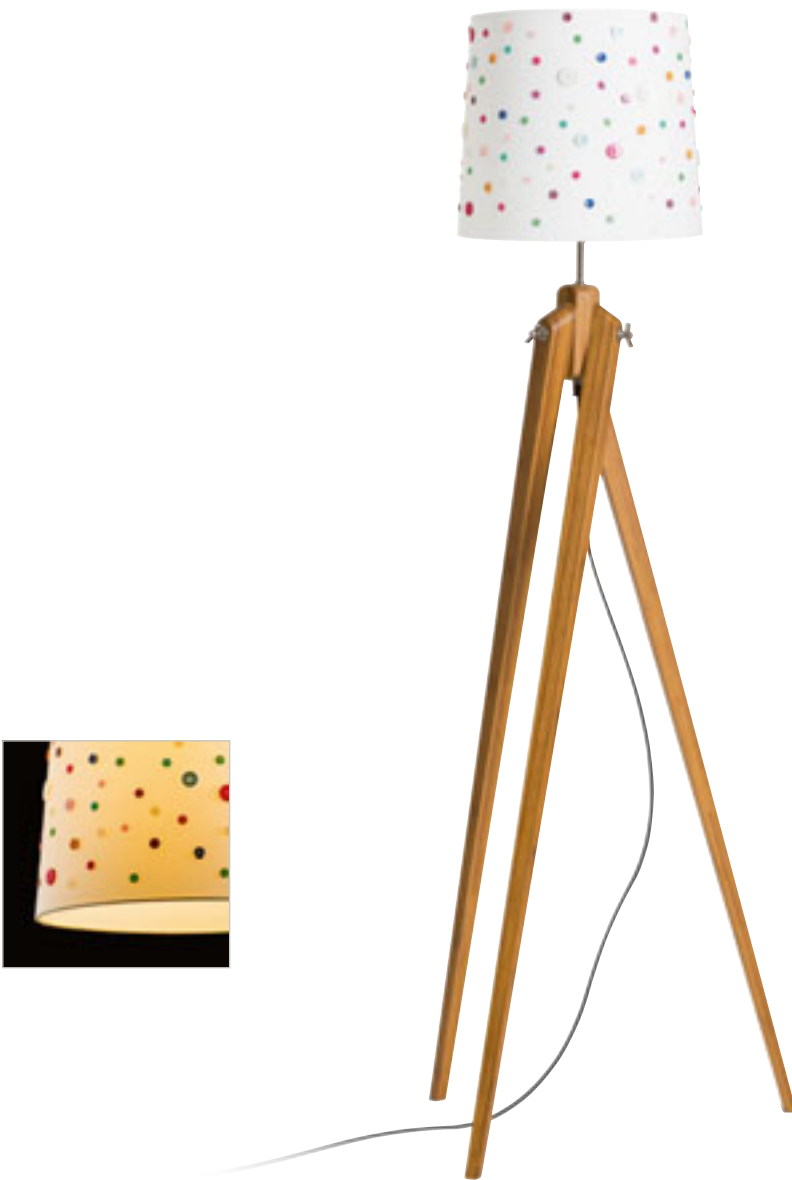

## DELISA

Abajur decorativo com botões coloridos adequados para conjuntos suspensos ou candeeiros de pé Acessórios adequados: HEX, ELISA, ENZO, LISA, KOMBIX, AMBITUS, ALVIS, CORTINA.

### DELISA 35/30 ABAJUR

max 28 W

R12389 branco/botões

€ 78

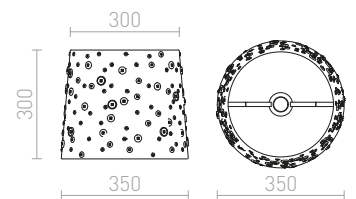

## DELISA

Abajur decorativo com botões coloridos adequados para conjuntos de candeeiros suspensos ou suportes para candeeiros de mesa. Acessórios adequados: HEX, ELISA, ENZO, KOMBIX, LISA, AMBITUS, ALVIS, CORTINA.

### DELISA 25/16 ABAJUR

max 28 W

R12388 branco/botões

€ 35

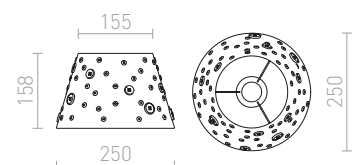



## DIFFUSER

Difusor circular para abajures têxteis.

### DIFFUSER R 60 PMMA

**G11869** acrílico fosco

€ 32

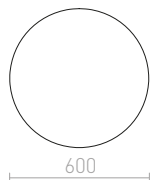

## RON

Abajur têxtil para casquilho E27. Instalação em base de teto ou conjunto de suspensão. O difusor PMMA (R11869, R12301) pode ser encomendado para o abajur, mas não é adequado para R11452. Acessórios adequados: HEX, ELISA, ENZO, LISA, POSTE, TRIX.

### RON 60/19 ABAJUR

max. 23 W

	<b>R11462</b> Poli-algodão preto/folha dourada	€ 178
	<b>R11479</b> Poli-algodão preto/folha de cobre	€ 178
	<b>R11490</b> Poli-algodão branco/PVC branco	€ 120
	<b>R11517</b> Chita laranja/PVC branco	€ 98
	<b>R11546</b> Chita menta/folha de prata	€ 188
	<b>R11555</b> Chita cinza claro/PVC branco	€ 98
	<b>R11565</b> Chita limão/PVC branco	€ 98
	<b>R11573</b> monaco gasolina azul/prata PVC	€ 188
	<b>R11584</b> monaco pomba gris/prata PVC	€ 188
	<b>R11607</b> Alperce de chita/PVC branco	€ 98
	<b>R13052</b> Poli-algodão preto/PVC branco	€ 120

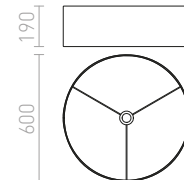



## DIFFUSER

Difusor circular para abajures têxteis.

### DIFFUSER R 55 PMMA

**G11868** acrílico fosco

€ 29

**G12300** claro

€ 32

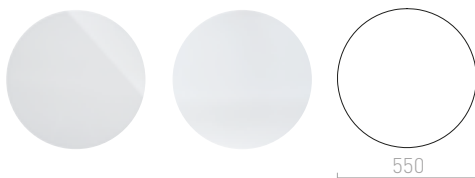

## RON

Abajur têxtil para casquilho E27. O abajur pode ser usado em bases de teto, conjuntos suspensos ou suportes como: HEX, ELISA, ENZO, LISA, POSTE, TRIX, IRIDIS, KOMBIX. O difusor PMMA (R11868, R12300) pode ser encomendado separadamente para o abajur.

### RON 55/30 ABAJUR

max. 23 W

	<b>R11463</b> Poli-algodão preto/folha dourada	€ 220
	<b>R11480</b> Poli-algodão preto/folha de cobre	€ 220
	<b>R11491</b> Poli-algodão branco/PVC branco	€ 120
	<b>R11518</b> Chita laranja/PVC branco	€ 98
	<b>R11556</b> Chita cinza claro/PVC branco	€ 98
	<b>R11566</b> Chita limão/PVC branco	€ 98
	<b>R11574</b> monaco gasolina azul/prata PVC	€ 188
	<b>R11585</b> monaco pomba gris/prata PVC	€ 188
	<b>R11608</b> Alperce de chita/PVC branco	€ 98
	<b>R13051</b> Poli-algodão preto/PVC branco	€ 120

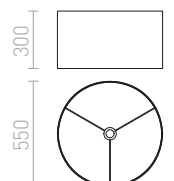



## DIFFUSER

Difusor circular para abajures têxteis.

### DIFFUSER R 40 PMMA

**G11867** acrílico fosco

€ 17.50

**G12299** claro

€ 19.50



## RON

Abajur têxtil para casquilho E27. Instalação em teto, conjunto de suspensão ou suportes. O difusor PMMA (R11867, R12299) pode ser encomendado para o abajur, mas não é adequado para R11455. Acessórios adequados: HEX, ELISA, ENZO, KOMBIX, LISA, KOMBIX, AMBITUS, ALVIS, CORTINA, NYC, NYC TRIPOD, WOODY.

### RON 40/25 ABAJUR

max 23 W

	<b>R11465</b> Poli-algodão preto/folha dourada	€ 138
	<b>R11481</b> Poli-algodão preto/folha de cobre	€ 138
	<b>R11493</b> Poli-algodão branco/PVC branco	€ 88
	<b>R11510</b> Alperce de chita/PVC branco	€ 78
	<b>R11520</b> Chita laranja/PVC branco	€ 78
	<b>R11549</b> Chita menta/folha de prata	€ 138
	<b>R11558</b> Chita cinza claro/PVC branco	€ 78
	<b>R11568</b> Chita limão/PVC branco	€ 78
	<b>R11576</b> monaco gasolina azul/prata PVC	€ 138
	<b>R11587</b> monaco pomba gris/prata PVC	€ 138
	<b>R13050</b> Poli-algodão preto/PVC branco	€ 88

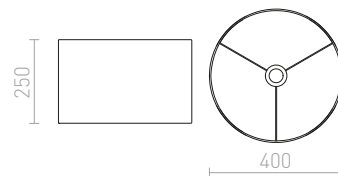



## RON

Abajur têxtil para casquilho E27 adequado para instalação em conjuntos suspensos ou suportes de mesa como: HEX, ELISA, ENZO, KOMBIX, LISA, MAIS, CORTINA, NYC.

### RON 15/20 ABAJUR

max 28 W

	<b>R11802</b> Poli-algodão preto/folha dourada	€ 98
	<b>R11803</b> Poli-algodão preto/folha de cobre	€ 98
	<b>R11804</b> Poli-algodão branco/PVC branco	€ 68
	<b>R11805</b> Alperce de chita/PVC branco	€ 68
	<b>R11806</b> Chita laranja/PVC branco	€ 68
	<b>R11809</b> Chita limão/PVC branco	€ 68
	<b>R11810</b> monaco pomba gris/prata PVC	€ 88
	<b>R11811</b> monaco gasolina azul/prata PVC	€ 88
	<b>R13049</b> Poli-algodão preto/PVC branco	€ 68

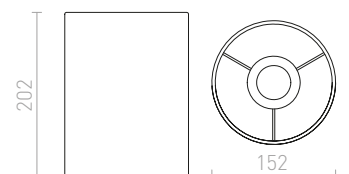





## DIFFUSER

Difusor circular para abajures têxteis.

### DIFFUSER R 55 PMMA

**G11868** acrílico fosco

€ 29

**G12300** claro

€ 32



## DOUBLE

Abajur têxtil para casquilho E27. Instalação no teto ou conjunto de suspensão. Um difusor PMMA (R11868, R12300) pode ser encomendado para o abajur. Acessórios adequados: HEX, ELISA, ENZO, KOMBIX, LISA, POSTE, TRIX.

### DOUBLE 55/30 ABAJUR

max. 23 W

	<b>R11477</b> Poli-algodão preto/folha dourada	€ 215
	<b>R11478</b> Poli-algodão preto/folha de cobre	€ 215
	<b>R11508</b> Alperce de chita/PVC branco	€ 120
	<b>R11516</b> Chita laranja/PVC branco	€ 120
	<b>R11545</b> Chita menta/folha de prata	€ 215
	<b>R11554</b> Chita cinza claro/PVC branco	€ 120
	<b>R11564</b> Chita limão/PVC branco	€ 120
	<b>R11600</b> Poli-algodão branco/PVC branco	€ 138

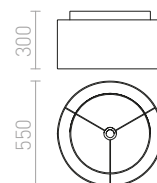



## DIFFUSER

Difusor circular para abajures têxteis.

### DIFFUSER R 40 PMMA

G11867 acrílico fosco

€ 17.50

G12299 claro

€ 19.50



## DOUBLE

Abajur têxtil para casquilho E27. Instalação no teto ou em conjunto de suspensão. O difusor PMMA (R11867, R12299) pode ser encomendado para o abajur. Acessórios adequados: HEX, ELISA, ENZO, KOMBIX, LISA.

### DOUBLE 40/30 ABAJUR

max 23 W

	<b>R11461</b> Poli-algodão preto/folha dourada	€ 178
	<b>R11507</b> Alperce de chita/PVC branco	€ 120
	<b>R11515</b> Chita laranja/PVC branco	€ 120
	<b>R11535</b> Chita azeitona/folha de prata	€ 120 %
	<b>R11544</b> Chita menta/folha de prata	€ 215
	<b>R11553</b> Chita cinza claro/PVC branco	€ 120
	<b>R11563</b> Chita limão/PVC branco	€ 120
	<b>R11599</b> Poli-algodão branco/PVC branco	€ 129

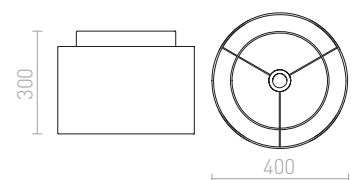



## DIFFUSER

Difusor quadrado para abajures têxteis.

### DIFFUSER SQ 50 PMMA

G11871 acrílico fosco

€ 32

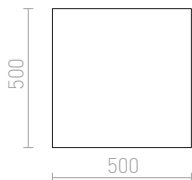

## TEMPO

Abajur têxtil para casquilho E27 a ser instalado em uma base de teto ou conjunto de suspensão. O difusor PMMA (R11871) pode ser encomendado para o abajur. Acessórios adequados: HEX, ELISA, ENZO, KOMBIX, LISA, NYC.

### TEMPO 50/19 ABAJUR

max. 23 W

	<b>R11475</b> Poli-algodão preto/folha dourada	€ 178
	<b>R11488</b> Poli-algodão preto/folha de cobre	€ 178
	<b>R11505</b> Poli-algodão branco/PVC branco	€ 98
	<b>R11513</b> Alperce de chita/PVC branco	€ 48 %
	<b>R11523</b> Chita laranja/PVC branco	€ 48 %
	<b>R11542</b> Chita azeitona/folha de prata	€ 48 %
	<b>R11551</b> Chita menta/folha de prata	€ 48 %
	<b>R11561</b> Chita cinza claro/PVC branco	€ 78

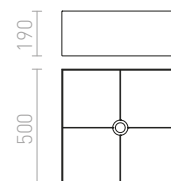



## DIFFUSER

Difusor quadrado para abajures têxteis.

### DIFFUSER SQ 30 PMMA

G11870 acrílico fosco

€ 18

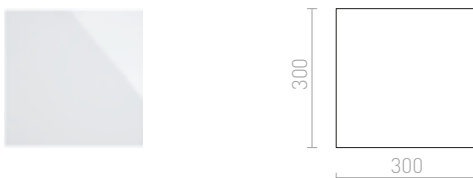

## TEMPO

Abajur têxtil para casquilho E27 para instalação em base de teto, conjunto de suspensão ou base de suporte. Um difusor PMMA (R11870) pode ser encomendado para o abajur. Acessórios adequados: SOLO, HEX, ELISA, ENZO, KOMBIX, LISA, NYC.

### TEMPO 30/19 ABAJUR

max 23 W

	<b>R11476</b> Poli-algodão preto/folha dourada	€ 129
	<b>R11489</b> Poli-algodão preto/folha de cobre	€ 129
	<b>R11506</b> Poli-algodão branco/PVC branco	€ 78
	<b>R11514</b> Alperce de chita/PVC branco	€ 48 %
	<b>R11524</b> Chita laranja/PVC branco	€ 48 %
	<b>R11543</b> Chita azeitona/folha de prata	€ 48 %
	<b>R11552</b> Chita menta/folha de prata	€ 48 %
	<b>R11562</b> Chita cinza claro/PVC branco	€ 38 %

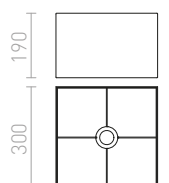



## TEMPO

Abajur têxtil para casquilho E27, apto para instalação em conjuntos suspensos ou em suportes de mesa. Acessórios adequados: HEX, ELISA, ENZO, KOMBIX, LISA, MAIS, NYC

### TEMPO 15/30 ABAJUR

max 28 W



**R11822**

Poli-algodão branco/PVC branco

€ 78

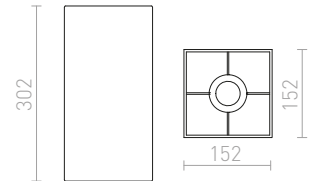

## TEMPO

Abajur têxtil para casquilho E27, apto para instalação em conjuntos suspensos ou suportes de mesa, por exemplo: HEX, ELISA, ENZO, KOMBIX, LISA, MAIS, NYC

### TEMPO 15/15 ABAJUR

max 28 W



**R11812**

Poli-algodão preto/folha dourada

€ 88



**R11813**

Poli-algodão preto/folha de cobre

€ 88

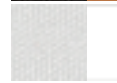

**R11814**

Poli-algodão branco/PVC branco

€ 58



**R11815**

Alperce de chita/PVC branco

€ 58



**R11816**

Chita laranja/PVC branco

€ 58

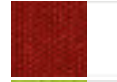

**R11817**

Chita terracota/PVC branco

€ 29

%



**R11819**

Chita limão/PVC branco

€ 58



**R11820**

monaco gasolina azul/prata PVC

€ 88

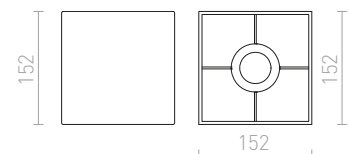



## CASUAL

Abajur têxtil para instalação na base do teto R11797 ou conjunto suspenso R11798.

### CASUAL 120/25 ABAJUR

max 23 W

	<b>R11471</b> Poli-algodão preto/folha dourada	€ 329
	<b>R11484</b> Poli-algodão preto/folha de cobre	€ 329
	<b>R11500</b> Poli-algodão branco/PVC branco	€ 178
	<b>R11582</b> monaco gasolina azul/prata PVC	€ 278
	<b>R11593</b> monaco pomba gris/prata PVC	€ 278

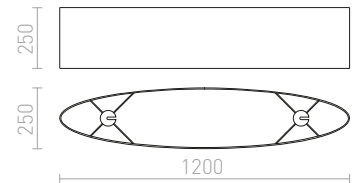

## CASUAL

Abajur têxtil para instalação na base do teto R11795 ou conjunto suspenso R11796.

### CASUAL 90/22 ABAJUR

max 23 W

	<b>R11472</b> Poli-algodão preto/folha dourada	€ 248
	<b>R11485</b> Poli-algodão preto/folha de cobre	€ 248
	<b>R11501</b> Poli-algodão branco/PVC branco	€ 178
	<b>R11583</b> monaco gasolina azul/prata PVC	€ 215
	<b>R11594</b> monaco pomba gris/prata PVC	€ 215

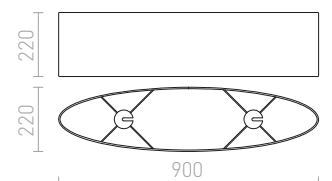



## LOPE

Abajur têxtil adequado para instalação na base do candeeiro de teto R11797 ou no conjunto suspenso R11798.

### LOPE 120/22 ABAJUR

max. 23 W

		<b>R11473</b> Poli-algodão preto/folha dourada	€ 320
		<b>R11486</b> Poli-algodão preto/folha de cobre	€ 320
		<b>R11502</b> Poli-algodão branco/PVC branco	€ 178
		<b>R11611</b> Alperce de chita/PVC branco	€ 88 %
		<b>R11616</b> Chita laranja/PVC branco	€ 88 %
		<b>R11634</b> Chita cinza claro/PVC branco	€ 88 %
		<b>R11639</b> Chita limão/PVC branco	€ 88 %

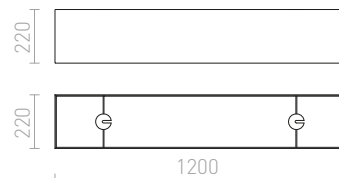



## LOPE

Abajur têxtil adequado para instalação na base do candeeiro de teto R11795 ou no conjunto suspenso R11796.

### LOPE 80/23 ABAJUR

max 23 W

	<b>R11474</b> Poli-algodão preto/folha dourada	€ 178
	<b>R11487</b> Poli-algodão preto/folha de cobre	€ 88 %
	<b>R11503</b> Poli-algodão branco/PVC branco	€ 138
	<b>R11511</b> Alperce de chita/PVC branco	€ 35 %
	<b>R11541</b> Chita azeitona/folha de prata	€ 88 %
	<b>R11550</b> Chita menta/folha de prata	€ 88 %
	<b>R11559</b> Chita cinza claro/PVC branco	€ 48 %
	<b>R11569</b> Chita limão/PVC branco	€ 35 %

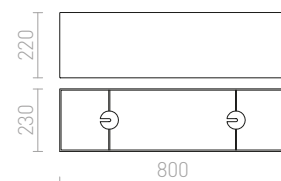





**MORE**

Base linear de teto em acabamento brilhante e mate de 60 ou 80 cm para a suspensão de três abajures. Adequada para abajures: RON 15/20, TEMPO 15/15, TEMPO 15/30.

**MORE 80 BASE PARA TETO SUSPENSO**

230 V E27 3x42 W

**R11776** níquel mate

€ 58

%

**R11777** cromo

€ 58

%

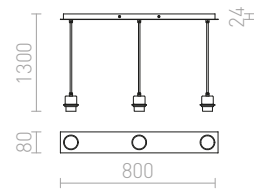

**MORE 60 BASE PARA TETO SUSPENSO**

230 V E27 3x42 W

**R11774** níquel mate

€ 48

%

**R11775** cromo

€ 48

%

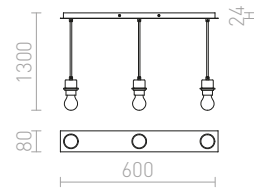



## RALLONG

Conjunto suspenso para abajures têxteis oblongos. RALLONG 4 pode ser combinado com os abajures CASUAL 90 e LOPE 80. RALLONG 5 pode ser combinado com os abajures CASUAL 120 e LOPE 120.

### RALLONG IV BASE PARA TETO SUSPENSO

230 V E27 4x42 W

R11796 cromo

€ 68

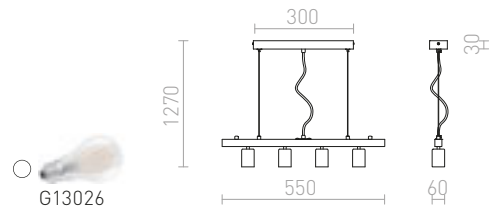

### RALLONG V BASE PARA TETO SUSPENSO

230 V E27 5x42 W

R11798 cromo

€ 68

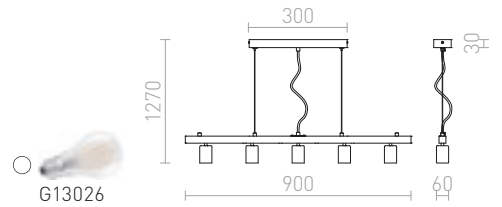

### RALLONG IV BASE PARA TETO

230 V E27 4x42 W

R11795 cromo

€ 32

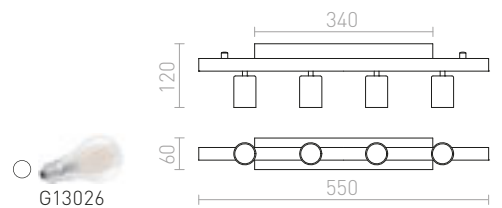

### RALLONG V BASE PARA TETO

230 V E27 5x42 W

R11797 cromo

€ 48

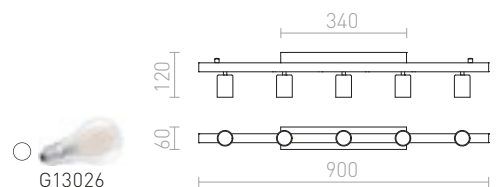

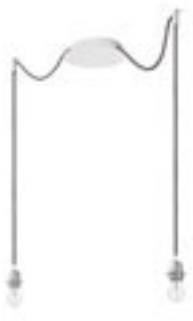

R11778  
€ 178

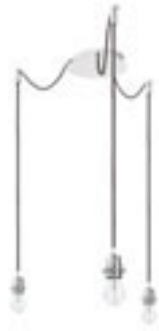

R11779  
€ 229



R11780  
€ 380



R11781  
€ 158



R11782  
€ 215



R11783  
€ 335



R11787  
€ 150



R11788  
€ 215



R11789  
€ 335

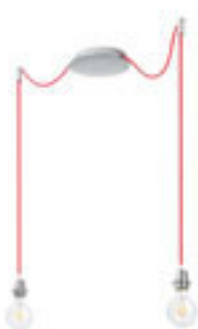

R11784  
€ 158



R11785  
€ 215

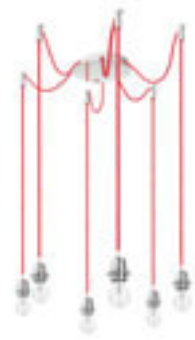

R11786  
€ 398



R11778 + R11563



R11783 + R11810



## KOMBIX

Luminária suspensa com base de teto central e cabos têxteis individuais com casquilho metálico E27, para uso com fontes de luz decorativas ou abajures têxteis adequados. Os cabos estão equipados com alças de cromo de teto, que podem ser colocadas a uma distância individual da base. Comprimento total do cabo 3m.

### KOMBIX 2 CONJUNTO DE SUSPENSÃO

230 V E27 2x28 W

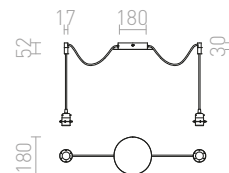

### KOMBIX 3 CONJUNTO DE SUSPENSÃO

230 V E27 3x28 W

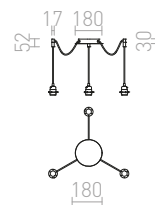
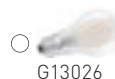

### KOMBIX 6 CONJUNTO DE SUSPENSÃO

230 V E27 6x28 W

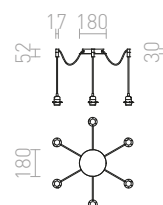



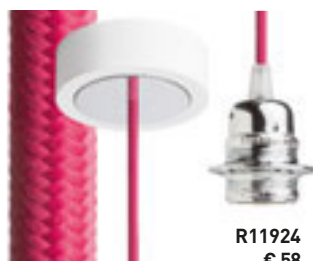

## HEX

Conjunto de suspensão com base decorativa, casquilho metálico E27 e cabo têtil. Pode ser utilizado com ou sem abajur. Apto para os seguintes para abajures: DOUBLE 40/30, DOUBLE 55/30, ASPRO 40/30, ASPRO 55/30, KARO 55/15, KARO 80/20, RON 40/25, RON 55/30, RON 60/19 TEMPO 30/19, TEMPO 50/19.

### HEX CONJUNTO DE SUSPENSÃO

230 V E27 28 W

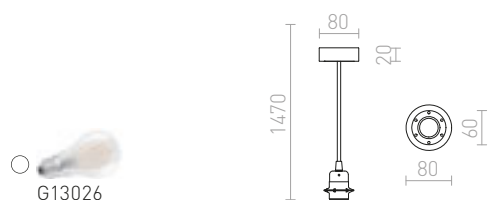



R11879  
€ 48



R11886  
€ 48



R11880  
€ 48



R11892  
€ 48



R11884  
€ 48



R11888  
€ 48



R11877  
€ 48



R11891  
€ 48



R11875  
€ 48



R11896  
€ 48



R11876  
€ 48



R11894  
€ 48



R11906  
€ 48



R11885  
€ 48



R11883  
€ 48



R11882  
€ 48



R11881  
€ 48

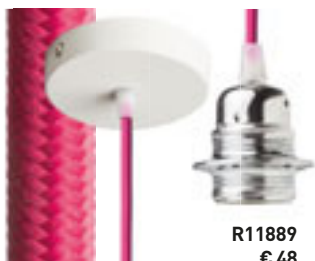

R11889  
€ 48



R11872  
€ 48



R11887  
€ 48



R11890  
€ 48



R11874  
€ 48



R11873  
€ 48



R11878  
€ 48



R11908  
€ 48



R11897  
€ 48



R11895  
€ 48



R11893  
€ 48



R11898  
€ 48



R11905  
€ 48



R11904  
€ 48



R11903  
€ 58



R11907  
€ 48



R11900  
€ 48



R11902  
€ 58



R11901  
€ 58



R11899  
€ 48

## ELISA

Conjunto de suspensão com base circular lacada branca, cabo têxtil e casquilho de metal E27. Para uso autónomo ou para suspensão de abajures leves. Adequada para os seguintes abajures: ARISTA, DELI, JAKARANDA, DOBLE 40/30, DOBLE 55/30, ASPRO 40/30, KARO 55/15, RON 40/25, RON 55/30, RON 60/19, TEMPO 30/19, TEMPO 50/19.

### ELISA CONJUNTO DE SUSPENSÃO

230 V E27 28 W



G13026

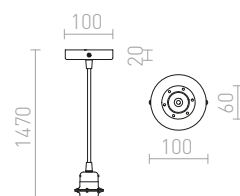





## FABIO

Conjunto de suspensão elegante com copo em porcelana e casquilho E27 sobre um cabo têxtil. Adequado somente com fontes de luz decorativas. Dimensões do bocal de cerâmica ØV 4.5/6 cm.

### FABIO CONJUNTO SUSPENSO

230 V E27 42 W

**R10617** preto/branco/porcelana

€ 32 %

**R10618** preto/porcelana

€ 32 %



G12246

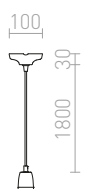



## LISA

Conjunto de suspensão com cabo têxtil, bocal de silicone E27 e copo de plástico. Adequados para os seguintes abajures: ARISTA, DELI, DELISA, JAKARANDA, DOUBLE 40/30, DOUBLE 55/30, ASPRO 40/30, ASPRO 55/30, KARO 55/15, KARO 80/20, RON 15/20, RON 40/25, RON 55/30, RON 60/19, TEMPO 15/15, TEMPO 15/30, TEMPO 30/19, TEMPO 50/19.

### LISA CONJUNTO SUSPENSO

230 V E27 42 W

<b>R10622</b> vermelho	<b>€ 18.50</b>	%
<b>R10623</b> verde	<b>€ 9.35</b>	%
<b>R10624</b> branco	<b>€ 24</b>	
<b>R10625</b> preto	<b>€ 24</b>	

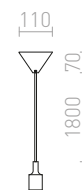

## ENZO

Conjunto suspenso com elementos cromados, cabo transparente e casquilho E27. Abajures adequados: ARISTA, DELI, DELISA, JAKARANDA, DOUBLE 40/30, DOUBLE 55/30, ASPRO 40/30, ASPRO 55/30, KARO 55/15, KARO 80/20, RON 15/20, RON 40/25, RON 55/30, RON 60/19, TEMPO 15/15, TEMPO 15/30, TEMPO 30/19, TEMPO 50/19.

### ENZO CONJUNTO SUSPENSO

230 V E27 42 W

<b>R10616</b> cromo	<b>€ 28</b>
---------------------	-------------

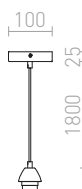



## SOLO

Base de teto para abajures têxteis com casquilho E27.  
Adequada para abajures: DELI 30/20, DOUBLE 40/30,  
JAKARANDA, RON 40/25, TEMPO 30/19.

### SOLO SQ BASE DE TETO

230 V E27 53 W

R12584 cromo

€ 28

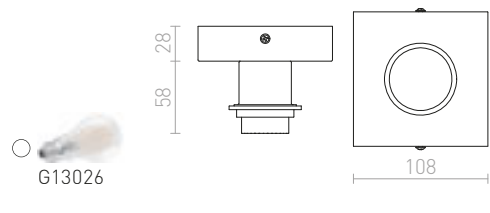

### SOLO R BASE DE TETO

230 V E27 53 W

R12583 cromo

€ 28

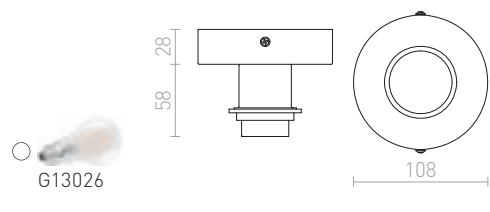

## POSTE

Base de teto cromada com três casquilhos E27  
ajustáveis. Adequada para abajures têxteis maiores que  
30 cm. Para abajures: DELI 55/30, DOUBLE 55/30, RON  
55/30, RON 60/19, TEMPO 50/19.

### POSTE BASE PARA TETO

230 V E27 3x20 W

R11799 cromo

€ 68

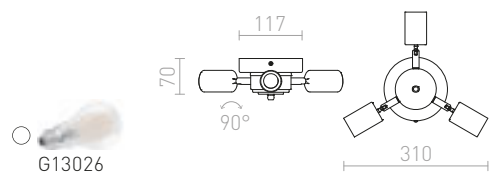



## TRIX

Conjunto de suspensão com três casquilhos inclináveis a 90°. Abajures adequados: DOUBLE 55/30, ASPRO 55/30, KARO 55/15, KARO 80/20, RON 55/30, RON 60/19, TEMPO 50/19.

### TRIX CONJUNTO SUSPENSO

230 V E27 3x42 W

R10615 cromo

€ 98

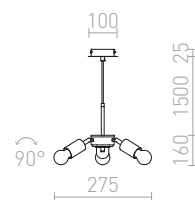
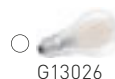



## SPIDER

Conjunto variável adequado para uso autónomo com uma fonte de luz E27 decorativa ou com um abajur leve. O conjunto pode ser fixado no teto ou parede usando as alças colocadas no cabo têxtil preto. O conjunto contém 4 peças de alças de plástico pretas ou 4 alças de cromo. Estas também podem ser pedidas separadamente. Adequada para abajures: ARISTA, ASPRO, DOUBLE, JAKARANDA, RON.

### SPIDER I CONJUNTO SUSPENSOS

230 V E27 15 W

**R13492** preto

**€ 58**

**R13493** preto/cromo

**€ 78**

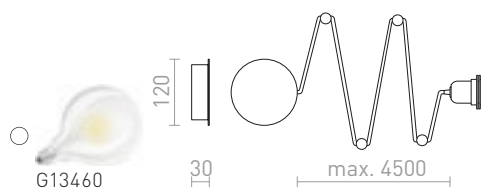



## SPIDER

Acessórios de substituição para o conjunto SPIDER R13492 e R13493.

### SPIDER JUNTA

R13494 preto/plástico

€ 2.20

R13495 cromo/metálico

€ 5.80

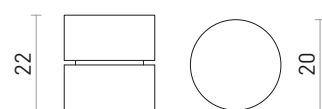





### HUDSON

Luminária de parede com braço cromado, cabo vertical e abajur cilíndrico têtil.

#### HUDSON NA PAREDE

230 V E27 28 W

R13284 branco/cromo

€ 138

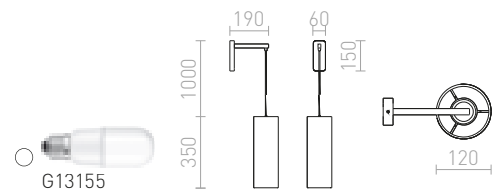

### BEND

Luminária de parede em níquel com interruptor localizado no cabo de alimentação. Adequada para abajures têxteis com acessórios E27. Adequada para abajures: RON 40/25, ASPRO 40/30.

#### BEND BASE ARQUEADA NA PAREDE

230 V E27 42 W

R12654 níquel mate

€ 150

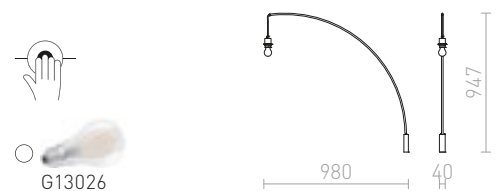





## NIZZA

Base de candeeiro de mesa com braço ajustável em madeira e base de metal lacada a preto. Cabo de têxtil preto. Para abajur com montagens E14 ou E27.

### NIZZA SUPORTE DE MESA

230 V E14 28 W

R12947 branco/madeira

€ 138

%



G12243

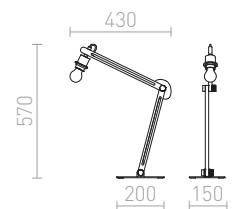



## NIZZA

Abajur têxtil para casquilho E27, adequado para instalação em conjuntos suspensos e candeeiros de mesa R12947.

### NIZZA 18/15 ABAJUR

max 28 W

**R13113** Poli-algodão branco/PVC branco

€ 58

**R13114** Poli-algodão preto/PVC branco

€ 58

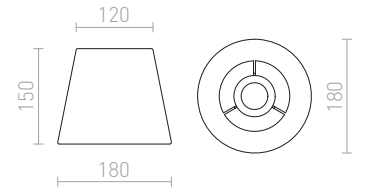

## WOODY

Suporte de candeeiro de pé com casquilho E27. O interruptor está localizado na base da casquilho E27 para facilitar a operação. Adequada para abajures: DELISA 25/16, CONNRY 15/30, CONNRY 35/30, RON 40/25, TEMPO 30/19.

### WOODY BASE CANDEEIRO DE MESA

230 V E27 25 W

**R11791** carvalho

€ 98

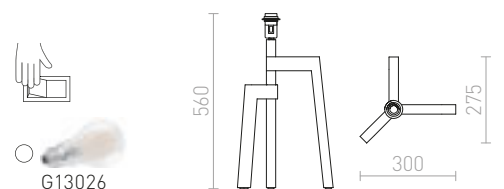

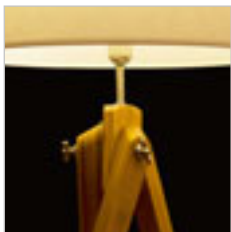

## AMBITUS

Base de candeeiro de mesa de bambu com casquilho E27. Abajures adequados: ALVIS 24/15, DELISA 25/16, CONNY 15/30, CONNY 35/30, RON 40/25, TEMPO 30/19.

### AMBITUS BASE CANDEEIRO DE MESA

230 V E27 28 W

R13303 bambu

€ 120



G13026

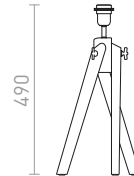

## AMBITUS

Base de candeeiro de pé de bambu com casquilho E27. Abajures adequados: AMBITUS 46/24, DELISA 35/30, CONNY 25/30, CONNY 35/30, RON 40/25, TEMPO 30/19.

### AMBITUS BASE CANDEEIRO DE PÉ

230 V E27 28 W

R13304 bambu

€ 258



G13461

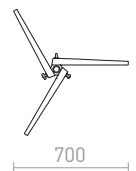
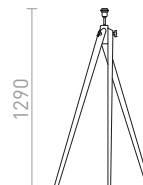



### ALVIS

Tripé para candeeiro de pé de bambu regulável em altura para abajures com montagem E27. Adequado para abajures: AMBITUS 46/24, DELISA 35/30, CONNY 25/30, CONNY 35/30, RON 40/25, TEMPO 30/19.

#### ALVIS BASE CANDEIRO DE PÉ

230 V E27 28 W

R13340 bambu/cromo

€ 215



G13461

775 - 1210

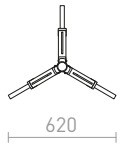

620

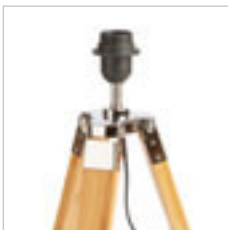

### ALVIS

Suporte para candeeiro de mesa em bambu para abajures com montagem E27. Indicado para abajures: ALVIS 24/15, DELISA 25/16, CONNY 15/30, CONNY 35/30, RON 40/25, TEMPO 30/19.

#### ALVIS BASE CANDEIRO DE MESA

230 V E27 28 W

R13339 bambu/cromo

€ 98



G13014

510

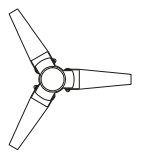
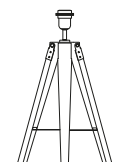

300



## KEITH

Base de mesa em imitação de faia com porta USB integrada. Combine com abajures com casquilho E27. Adequada para abajures: CONNY 15/30, DELI 30/20, DELISA 25/16, RON 15/20.

### KEITH BASE DE SUPORTE COM USB

230 V E27 40 W

R13639 branco/faia

€ 98



G13026

400

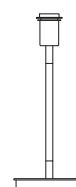

160



## LUTON

Tripé elegante em preto com acessórios de latão.

Combine com abajures com casquilho E27. Adequada para abajures: AMBITUS 46/24, DELISA 35/30, CONNY 25/30, CONNY 35/30, RON 40/25, TEMPO 30/19.

### LUTON BASE DE PÉ

230 V E27 40 W

R13640 preto/latão

€ 150



G13026

1000 - 1560



935

600



## MAUI

Suporte de candeeiro de mesa de madeira com casquilho E27. Abajures adequados: CONNY 15/30, DELI 30/20, DELISA 25/16, RON 15/20.

### MAUI BASE CANDEEIRO DE MESA

230 V E27 20 W

R13437 madeira

€ 48 %



G13014

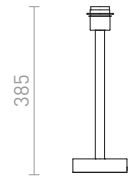

## NYC

Suporte de pé cromado para abajures com montagem E27. Abajures adequados: CONNY 25/30, CONNY 35/30, JAKARANDA, RON 40/25, TEMPO 30/19.

### NYC TRIPOD TRIPOD CANDEEIRO DE PÉ

230 V E27 42 W

R11992 cromo

€ 120



G13026

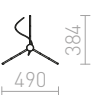



## CORTINA

Base para candeeiro de mesa para abajures com montagem no casquilho E27. Adequado para abajures: CONNY 15/15, CONNY 15/30, RON 15/20, TEMPO 15/15, TEMPO 15/30.

### CORTINA ABAJUR DE MESA

230 V E27 28 W

R12927 cinzento

€ 25 %

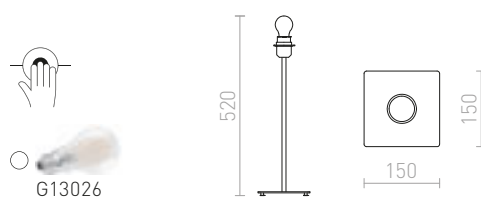

## CORTINA

Base de metal para candeeiro de pé para abajures com montagem no casquilho E27. Adequada para abajures: CONNY 25/30, CONNY 35/30, RON 40/25, TEMPO 30/19.

### CORTINA BASE CANDEEIRO DE PÉ

230 V E27 28 W

R12930 preto

€ 78

R13809 branco

€ 78





### NYC

Suporte de mesa em metal brilhante e mate para abajures com montagem E27. Adequado para abajures: CONNY 15/15, CONNY 15/30, RON 15/20, TEMPO 15/15, TEMPO 15/30.

#### NYC BASE CANDEEIRO DE MESA

230 V E27 42 W

R11990 cromo

€ 48

R12041 níquel mate

€ 48



G13026

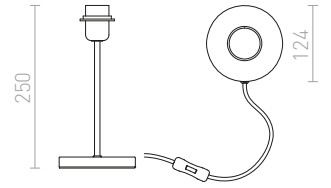

### NYC

Suporte de pé com acabamento cromado para abajures com montagem E27. Adequado para abajures CONNY 25/30, CONNY 35/30, JAKARANDA, RON 40/25, TEMPO 30/19.

#### NYC CANDEEIRO DE PÉ

230 V E27 42 W

R11991 cromo

€ 120



G13026

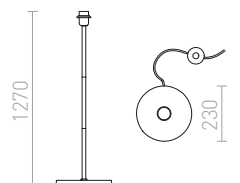





## FIT

Cabo triplo com trança têxtil em diferentes cores, comprimento 4 m.

### FIT 3x0,75 4M CABO TÊXTEL

230 V

R10251 preto

€ 24

R10252 branco

€ 14 %

R10253 vermelho

€ 14 %

R10254 cinzento

€ 14 %

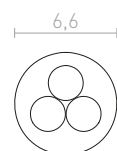

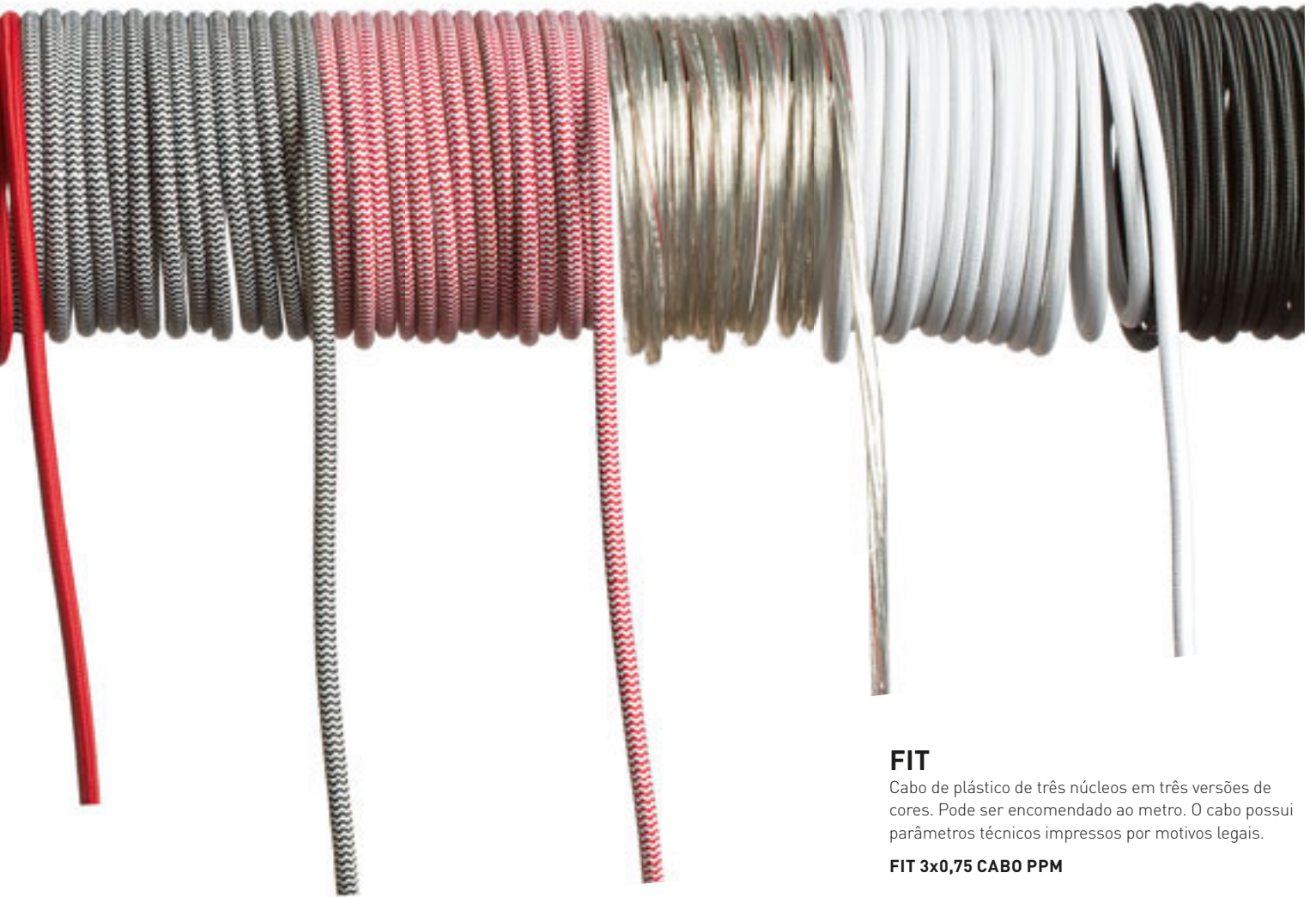

### FIT

Cabo de plástico de três núcleos em três versões de cores. Pode ser encomendado ao metro. O cabo possui parâmetros técnicos impressos por motivos legais.

#### FIT 3x0,75 CABO PPM

R12228	transparente	€ 3.50
R12229	cinzento	€ 3.20
R12230	preto	€ 3.20

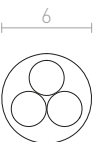

### FIT

Cabo triplo com trança têxtil em cores diferentes. Pode ser encomendado a metro de acordo com as necessidades.

#### FIT 3x0,75 CABO TÊXTEL PPM

R12214	branco	€ 5
R12216	preto/branco	€ 5
R12222	preto	€ 5
R12223	cinzento	€ 5
R12224	vermelho	€ 5
R12225	lima	€ 5
R12226	fuchsia	€ 5
R12227	vermelho/branco	€ 5

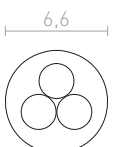
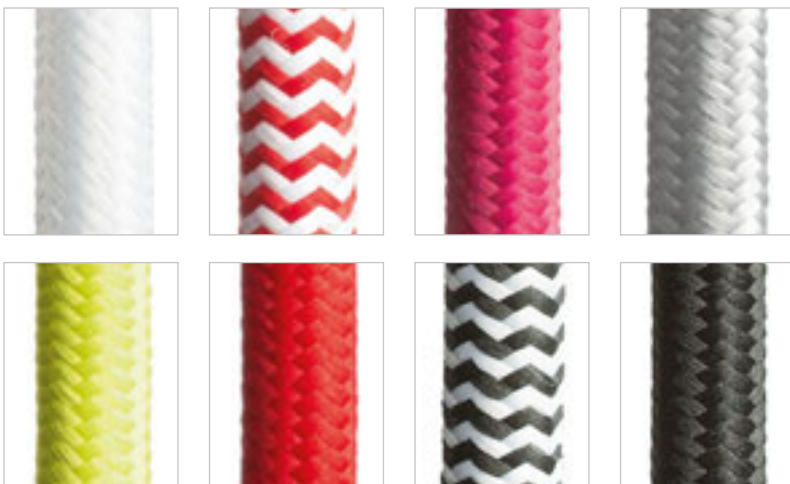

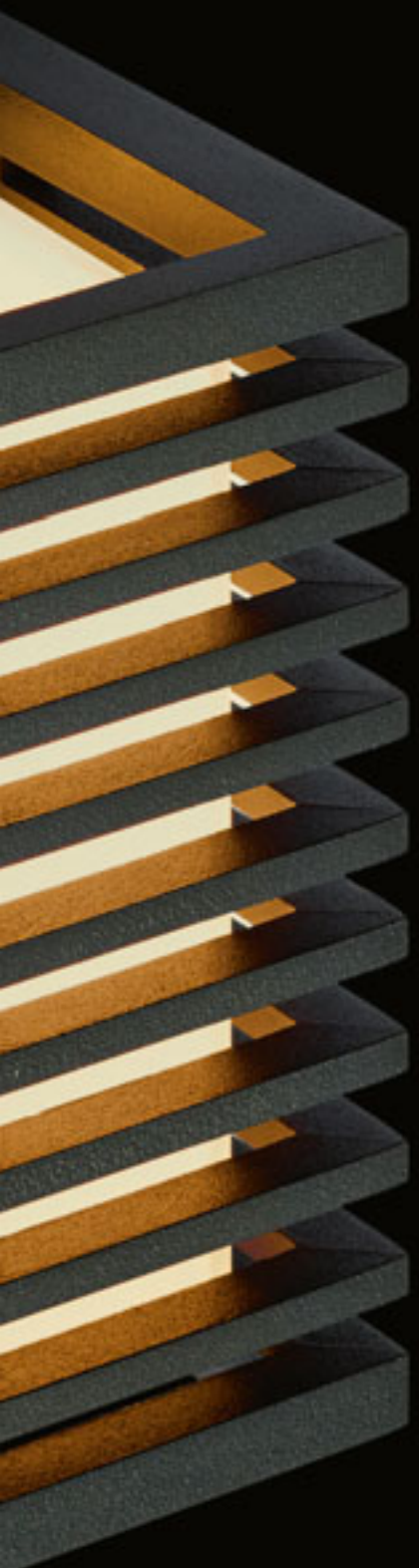

## ILUMINAÇÃO EXTERIOR

DECORATIVO	630-631
CONJUNTOS	632-647
TETO	648-655
INDIRETO	656-657
PAREDE ANGULAR	658-671
ACIMA - ABAIXO	672-693
PAREDE DIRECIONAL	694-697
DE ESTACA	698-703
CANDEEIROS DE ORIENTAÇÃO	704-711
EMBUTIDO EM PAREDE	712-723
EMBUTIDO NO SOLO	724-725

## ILUMINAÇÃO EXTERIOR DECORATIVO



**BABYMOON 56**  
630-631



**BEACON**  
630-631

## ILUMINAÇÃO EXTERIOR CONJUNTOS



**ELIA**  
632-633



**ELIA PIR**  
632-633



**ELIA**  
632-633

632-647



**BOSANOVA 120**  
632-633



**BOSANNA 150**  
632-633



**BONNIE**  
634-635



**BONNIE 80**  
634-635



**CLYDE**  
634-635



**CLYDE 60**  
634-635



**VADIS**  
636-637



**VADIS 90**  
636-637



**GARRET**  
636-637



**ABAX 65**  
638-639



**SONET**  
638-639



**SONET 450**  
638-639



**PONDER 20**  
640-641



**PONDER 65**  
640-641



**TREEZA LED 25**  
640-641



**TREEZA 65**  
640-641



**RINA**  
642-643



**RINA**  
642-643



**RINA PIR**  
642-643



**GARDIEN 65**  
642-643



**BOBO RC**  
642-643



**LIZZI**  
644-645



**LIZZI I**  
644-645



**LIZZI II**  
644-645



**SORANO**  
644-645



**SORANO II**  
644-645



**MIZZI NEW I**  
646-647



**MIZZI NEW II**  
646-647



**MIZZI II**  
646-647

## ILUMINAÇÃO EXTERIOR TETO



**SENZA R**  
648-649



**ORIN R**  
648-649



**SAMMY**  
648-649

648-655



**MERIDO**  
648-649



**QUADRA M**  
650-651



**RODGE**  
650-651



**KEIG**  
650-651



**SENZA SQ**  
650-651



**ORIN SQ**  
650-651



**SONYA 30**  
652-653



**SONYA RC**  
652-653



**SONNY**  
652-653



**SCOTT**  
654-655



**SPECTACLE**  
654-655



**TARIS SQ 17**  
654-655



**BONO**  
654-655

## ILUMINAÇÃO EXTERIOR INDIRETO



**ATLANTA 13**  
656-657



**ATHI**  
656-657



**TWIST**  
656-657

## ILUMINAÇÃO EXTERIOR PAREDE ANGULAR



**CLAIRE RC**  
658-659

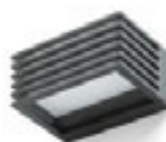

**CLAIRE 14**  
658-659



**CLAIRE 21**  
658-659

658-671



**TIRAS II**  
658-659



**WOOP**  
660-661



**TORINO**  
660-661



**CAMARGUE**  
660-661



**SAMPO**  
660-661



**DURANT**  
662-663



**GINO**  
662-663



**DURANT UP - DOWN**  
662-663



**DELTA 145**  
664-665



**DELTA 145**  
664-665



**DELTA 215**  
664-665



**DELTA 215**  
664-665



**DELTA RC**  
666-667



**CHICAGO**  
666-667



**VERIA**  
666-667



**ATHI**  
666-667



**HIDE SQ**  
668-669



**HIDE RC**  
668-669



**ANDANTE**  
668-669



**VECINO**  
670-671



**CHLOE**  
670-671



**TAPA**  
670-671



**GAVIN**  
670-671

## ILUMINAÇÃO EXTERIOR ACIMA - ABAIXO

672-693



**VIRGO**  
672-673



**XYLO**  
672-673



**COMODO**  
672-673



**TWIST**  
672-673



**CABOX II**  
674-675



**TELO**  
674-675



**MIZZI SQ I**  
674-675



**DESMOND II**  
674-675



**CARRE**  
676-677



**TITO R**  
676-677



**TITO SQ**  
676-677



**KANE I**  
678-679



**KANE II**  
678-679



**GRANITA II**  
678-679



**ZAZA**  
680-681



**PIA**  
680-681



**GIGI**  
680-681

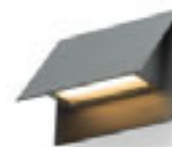

**GERI**  
680-681



**BOURDON**  
682-683



**PIPER**  
682-683



**SIV**  
682-683



**SELMA**  
682-683



**ZACK I**  
684-685





**ZACK II**  
684-685



**BEJA II**  
684-685



**MIDZACK**  
684-685



**KORSO I**  
686-687



**KORSO II**  
686-687



**KUBI I**  
686-687



**KUBI II**  
686-687



**DIXIE 4x12**  
688-689



**DIXIE 10x16**  
688-689



**PEKKO**  
688-689



**UKKO**  
688-689



**NICK II**  
688-689



**MOIRE I**  
690-691



**MOIRE II**  
690-691



**MICO I**  
690-691



**ZANE**  
690-691



**CHOIX 114**  
692-693



**CHOIX 175**  
692-693



**LESA**  
692-693



**MORA**  
692-693

## ILUMINAÇÃO EXTERIOR PAREDE DIRECIONAL

694-697



**DIREZZA**  
694-695



**ORIT**  
694-695



**FOX**  
694-695



**BORA**  
696-697



**PONTA**  
696-697

## ILUMINAÇÃO EXTERIOR DE ESTACA

698-703



**CORDOBA**  
698-699



**DIREZZA**  
698-699



**GUN**  
698-699



**BLUESTAR**  
698-699



**COSMO**  
700-701



**GARY LED**  
700-701



**BORA**  
700-701



**LORCA**  
700-701



**HEAVY DUTY**  
702-703



**ROSS**  
702-703



**FOX**  
702-703



702-703

## ILUMINAÇÃO EXTERIOR CANDEIROS DE ORIENTAÇÃO

704-711



**FAROS**  
704-705



**TOPTOP S**  
704-705



**TOPTOP IV**  
704-705



**BOBO R**  
706-707



**BOBO RC**  
706-707



**BOBO SQ**  
706-707



**RENO SQ INDR**  
708-709



**RENO SQ DR**  
708-709



**RENOR**  
708-709



**AQILA R**  
710-711



**AQILA SQ**  
710-711



**AQILA RC**  
710-711



**ITAKA**  
710-711

# ILUMINAÇÃO EXTERIOR EMBUTIDO EM PAREDE



**KICK I**  
712-713



**KICK II**  
712-713



**KICK III**  
712-713

712-723



**ASTERIA**  
714-715



**MARCO**  
714-715



**ELICA R**  
714-715



**CLUB**  
714-715



**CLUB IND**  
714-715



**ELICA SQ**  
716-717



**TESS SQ**  
716-717



**PER**  
716-717



**RASQ**  
716-717



**GORDIQ S**  
718-719



**GORDIQ L**  
718-719



**GORDIQ M**  
718-719



**RAGG**  
718-719



**DEJAVU SQ 9**  
720-721



**DEJAVU SQ 14**  
720-721



**FACA**  
722-723



**GAP**  
722-723



**AKORD**  
722-723



**SEGNO**  
722-723

## ILUMINAÇÃO EXTERIOR EMBUTIDO NO SOLO



**NAVY**  
724-725



**TERRA**  
724-725



**ORBUR**  
724-725



**RIZZ SQ 105**  
724-725



**ORBUSQ 10**  
724-725





IP44

IP44

### BABYMOON

Esfera de opala em termoplástico para fontes de luz de baixo consumo energético, adequadas para uso no jardim. A luz pode ser usada como suspensa ou no chão. Inclui um cabo de alimentação de 170 cm.

#### BABYMOON 56 SUSPENSO OU DE PÉ

230 V E27 23 W IP44

R10372 PE acetinado

€ 398

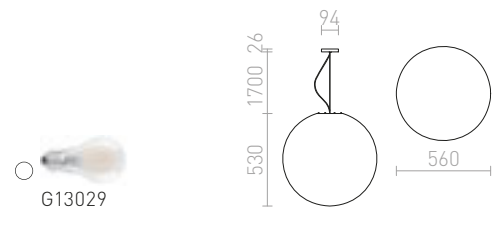

IP44



### BEACON

Candeeiro de parede retro para exterior com máscara de vidro transparente para fonte de luz com casquilho E27.

#### BEACON NA PAREDE

230 V E27 60 W IP44

R13614 preto/vidro texturado

€ 120

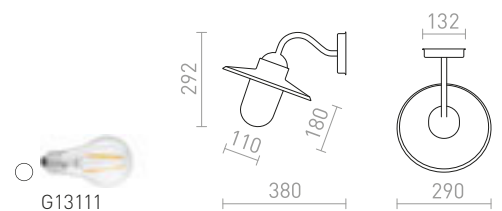



IP65

IP65

## BOSANOVA

Luminária de pé exterior com abajur de plástico. O cabo de alimentação é fornecido com uma ficha de segurança.

### BOSANOVA 120 DE PÉ

230 V E27 25 W IP65

R12420 cinzento antracite/PE acetinado

€ 380 →



G13026

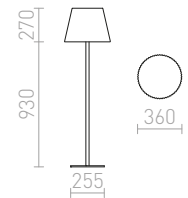

## BOSANNA

Luminária de pé exterior com abajur de plástico. O cabo de alimentação é fornecido com uma ficha de segurança.

### BOSANNA 150 DE PÉ

230 V E27 25 W IP65

R12421 cinzento antracite/PE acetinado

€ 380 →



G13026

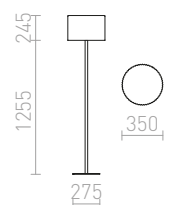



IP44

### ELIA

Candeeiro de parede exterior em alumínio maciço com LED incorporado e difusor de cor opala, da série ELIA

#### ELIA NA PAREDE

230 V LED 9 W 3000 K 720 lm Ra 80 IP44

R13930 cinzento antracite

€ 88

NEW

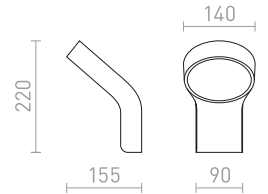

IP44



### ELIA

Candeeiro de parede exterior em alumínio maciço com LED incorporado e difusor de cor opala, da série ELIA. Inclui um sensor de movimento configurável.

#### ELIA PIR NA PAREDE

230 V LED 9 W 3000 K 720 lm Ra 80 IP44

R13931 cinzento antracite

€ 120

NEW

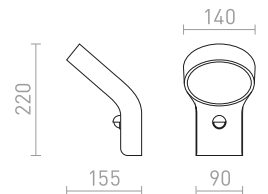

IP44



### ELIA

Poste exterior de alumínio maciço com LED incorporado e difusor de cor opala, da série ELIA.

#### ELIA DE PÉ

230 V LED 9 W 3000 K 720 lm Ra 80 IP44

R13932 cinzento antracite

€ 158

NEW

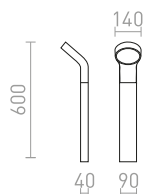





IP44

## BONNIE

Candeeiro de parede exterior com tampa opala para fonte de luz LED com casquilho E27.

### BONNIE NA PAREDE

230 V E27 28 W IP44

R13635 cinzento antracite

€ 48



G13307

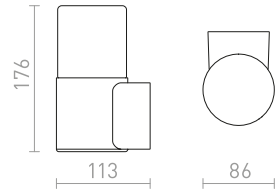

IP44

## BONNIE

Candeeiro de pé exterior com tampa opala para fonte de luz LED com casquilho E27.

### BONNIE 80 VERTICAL

230 V E27 28 W IP44

R13636 cinzento antracite

€ 129



G13307

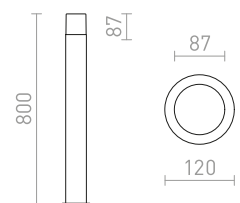



IP44

## CLYDE

Candeeiro de parede exterior com tampa opala para fonte de luz LED com casquilho E27.

### CLYDE NA PAREDE

230 V E27 28 W IP44

R13637 cinzento antracite

€ 58

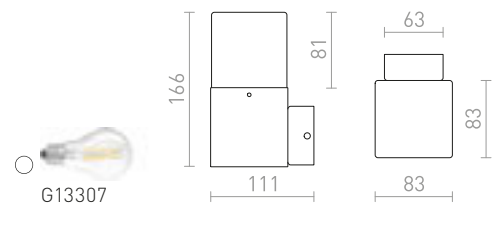

IP44



## CLYDE

Candeeiro de pé exterior com tampa opala para fonte de luz LED com casquilho E27.

### CLYDE 60 VERTICAL

230 V E27 28 W IP44

R13638 cinzento antracite

€ 120

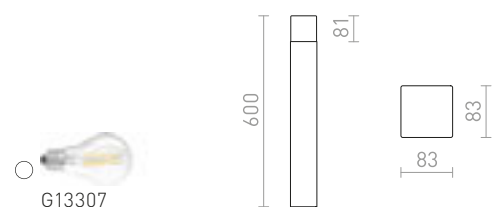



IP65

## GARRET

Luminária de parede LED cilíndrica de exterior com iluminação ambiente.

### GARRET NA PAREDE

230 V LED 15 W 3000 K 750 lm Ra 80 IP65

R12548 cinzento antracite

€ 88

%

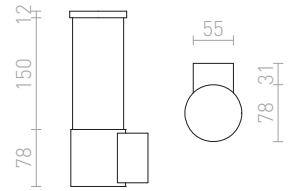

IP54

## VADIS

Luminária de exterior com tecnologia LED. O abajur é feito de policarbonato fosco.

### VADIS NA PAREDE

230 V LED 8 W 3000 K 520 lm Ra 80 IP54

R10547 cinzento antracite

€ 150

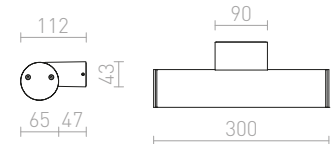

IP54

## VADIS

Baliza de exterior em alumínio lacado com LED integrado e laca de acrílico fosco.

### VADIS 90 VERTICAL

230 V LED 8 W 3000 K 520 lm Ra 80 IP54

R10548 cinzento antracite

€ 220

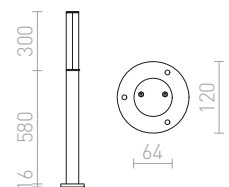





IP54



## SONET

Luminária exterior projetada apenas para montagem em parede. Classe de proteção IP54. Iluminação descendente.

### SONET NA PAREDE

230 V LED 7 W 3000 K 490 lm Ra 80 IP54

R111170 cinzento antracite

€ 129

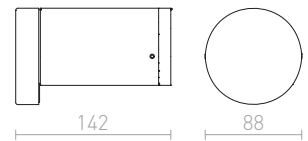
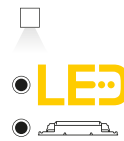

IP54



## ABAX

Baliza cilíndrica de exterior com LED integrado para iluminação geral.

### ABAX 65 DE PÉ

230 V LED 15 W 3000 K 423 lm Ra 80 IP54

R12626 cinzento antracite

€ 290

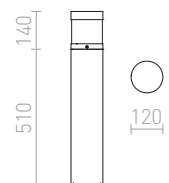



IP54

### SONET

Baliza ao ar livre com LED integrado para iluminar estradas e pavimentos.

#### SONET 450 VERTICAL

230 V LED 7 W  $\angle 55^\circ$  3000 K 477 lm Ra 80 IP54

R11171 cinzento antracite

€ 198

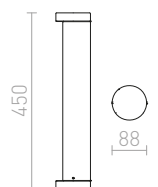
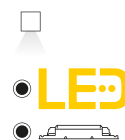



IP54

IP54

## TREEZA

Baliza ao ar livre com a área da fonte de luz lacada com cor dourada, o que cria uma luz macia e morna.

### TREEZA LED 25 VERTICAL

230 V LED 7 W  $\angle 60^\circ$  3000 K 123 lm Ra 80 IP54

R10380 cinzento antracite

€ 178

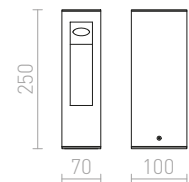

## TREEZA

Baliza ao ar livre para fontes de luz com baixo consumo energético E27. O vidro é acetinado.

### TREEZA 65 VERTICAL

230 V E27 26 W IP54

R10441 cinzento antracite

€ 150

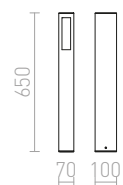



IP44

IP44

### PONDER

Luminária de pé para exteriores de alumínio fundido com abajur de vidro acetinado. Pode ser utilizada tanto na parede, como no chão.

#### PONDER 20 PAREDE OU LEVANTADO

230 V E27 18 W IP44

R10367 preto

€ 98

R10368 cinzento prata

€ 78 →

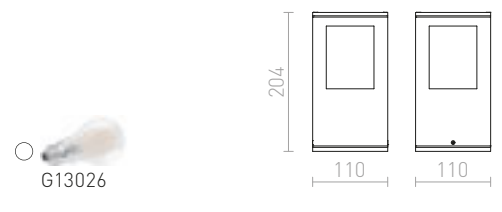

### PONDER

Baliza ao ar livre para fontes de luz com baixo consumo energético E27 e cobertura de vidro acetinado.

#### PONDER 65 SUPORTE

230 V E27 18 W IP44

R10433 preto

€ 158







IP65



### BOBO

Poste de exterior em alumínio com LED incorporado, para iluminação diagonal descendente de caminhos e entradas.

#### BOBO RC DE PÉ

230 V LED 8W 3000 K 640 lm Ra 80 IP65

R13936 cinzento antracite

€ 150 **NEW**

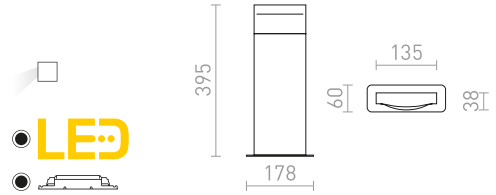

IP44

### RINA

Baliza ao ar livre de alumínio fundido com LED integrado e cobertura inferior de opala. Apenas para iluminação descendente.

#### RINA DE PÉ

230 V LED 12W 3000 K 1000 lm Ra 80 IP44

R12515 cinzento antracite

€ 198

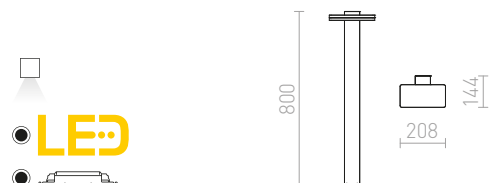



IP65

## RINA

Luminária de parede LED exterior de alumínio fundido com LED integrado e uma cobertura inferior em cor opala. Apenas para iluminação descendente.

### RINA NA PAREDE

230 V LED 12 W 3000 K 1000 lm Ra 80 IP65

cinzento antracite

€ 150

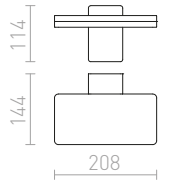
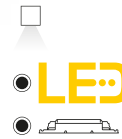

IP65

## RINA

Aplique LED para exterior com sensor integrado - possibilidade de definir funções. Apenas para iluminação descendente. Fabricado em alumínio fundido, tampa inferior opala.

### RINA PIR NA PAREDE

230 V LED 12 W 3000 K 900 lm Ra 80 IP65

R13654 cinzento antracite

€ 178

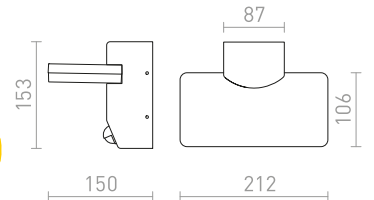
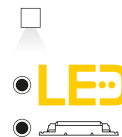

IP54

## GARDIEN

Candeeiro de pé LED para exterior em alumínio fundido com iluminação descendente. Os LEDs são cobertos por uma tampa de vidro fosco.

### GARDIEN 65 VERTICAL

230 V LED 10 W 3000 K 600 lm Ra 80 IP54

R13758 preto

€ 178

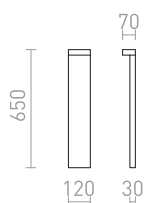
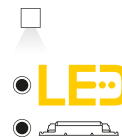



IP54

### LIZZI

Foco externo com casquilho GU10.

#### LIZZI TETO

230 V GU10 35 W IP54

R13505 branco

€ 58

R13507 cinzento antracite

€ 58

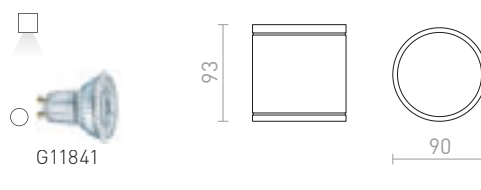

IP54

IP54

### LIZZI

Foco de alumínio para exteriores para fontes de luz GU10. O tamanho da base é A/L/D 10/6/3.1 cm.

#### LIZZI I NA PAREDE

230 V GU10 35 W IP54

R13508 cinzento antracite

€ 68

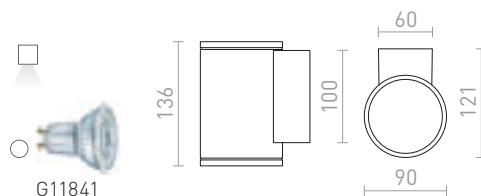

#### LIZZI II NA PAREDE

230 V GU10 2x35 W IP54

R13509 cinzento antracite

€ 78

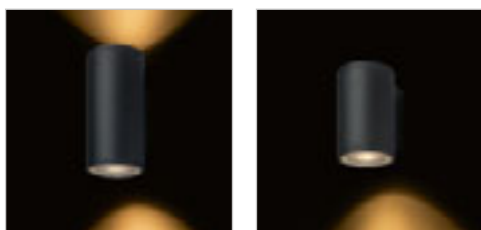
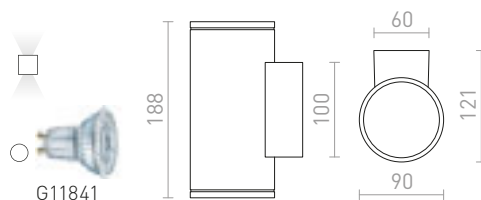



IP44



IP44



## SORANO

Cilindro de teto em fibra de carbono para fonte de luz LED com casquilho GU10. O corpo de carbono da luminária tem uma elevada resistência à água salgada.

### SORANO TETO

230 V LED GU10 8 W IP44

R13633 preto/plástico

€ 24

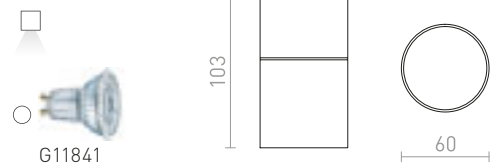

### SORANO II NA PAREDE

230 V LED GU10 2x8 W IP44

R13634 preto/plástico

€ 35

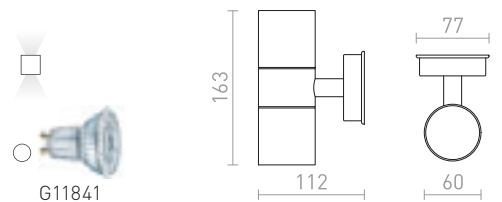



IP65

## MIZZI NEW

Candeeiro de parede de exterior em alumínio fundido para fontes de luz com casquilho GU10.

### MIZZI NEW I NA PAREDE

230 V GU10 35 W IP65

**R13755** cinzento antracite

€ 48

**R13796** cinzento prata

€ 48

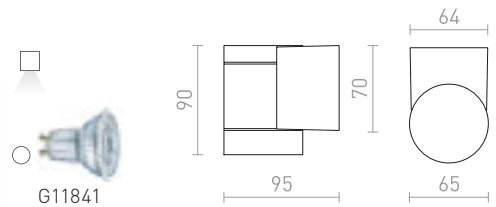

### MIZZI NEW II NA PAREDE

230 V GU10 2x35 W IP65

**R13643** cinzento antracite

€ 58

**R13797** cinzento prata

€ 58

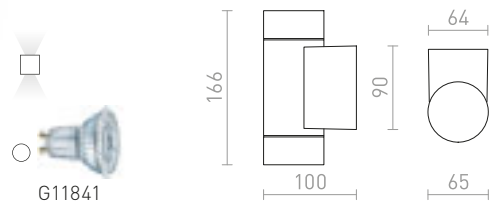

IP54



## MIZZI

Aplique de exterior em alumínio fundido para fontes de luz com GU10.

### MIZZI II

230 V GU10 2x35 W IP54

**R10553** cinzento prata

€ 48

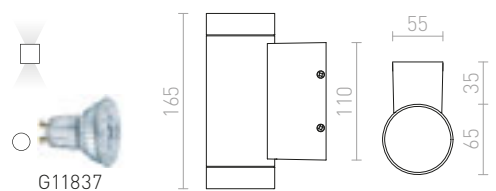





IP54



## MERIDO

Luminária de teto exterior para fontes de luz GX53 de baixo consumo energético.

### MERIDO TETO

230 V GX53 11 W IP54

R10428 branco

€ 58

R10429 cinzento prata

€ 58

R10430 cinzento antracite

€ 58

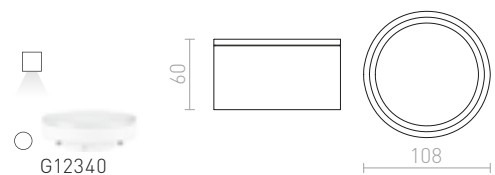



IP54

## ORIN

Iluminação de teto cilíndrica LED para exterior com abajur acetinado.

### ORIN R TETO

230 V LED 10 W 3000 K 650 lm Ra 80 IP54

R13626 branco/acrílico acetinado

€ 78

R13627 cinzento antracite/acrílico acetinado

€ 78

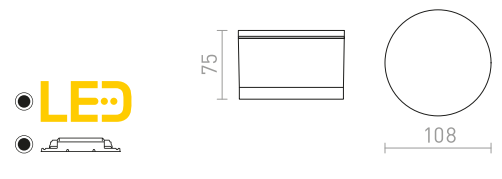

IP65

## SENZA

Plafon LED para exterior. Luminária cilíndrica com tampa de vidro transparente preto em todo o perímetro.

### SENZA R TETO

230 V LED 6 W 3000 K 480 lm Ra 80 IP65

R13622 branco/vidro transparente

€ 98

R13623 cinzento antracite/vidro transparente

€ 98

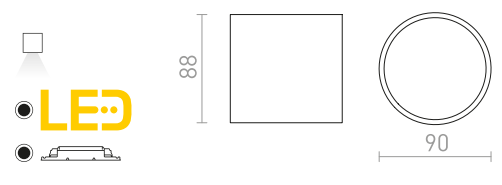

IP54

## SAMMY

Foco de exterior com casquilho GU10. Com cobertura de vidro transparente na parte inferior.

### SAMMY TETO

230 V LED GU10 15 W IP54

R13450 branco

€ 58

R13451 cinzento

€ 48

R13452 cinzento antracite

€ 58

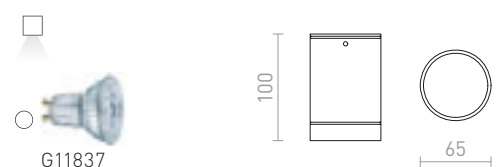





IP65

## KEIG

Iluminação de teto quadrada para exterior para fonte de luz LED com casquilho GU10.

### KEIG TETO

230 V GU10 35 W IP65

R13631 branco

€ 48

R13632 preto

€ 48



G11841

103

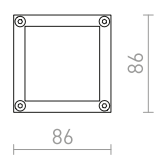

86



IP54

## RODGE

Foco de exterior com casquilho GU10.

### RODGE TETO

230 V GU10 35 W IP54

R13503 branco

€ 48

R13510 cinzento

€ 48

R13511 cinzento antracite

€ 58



G11841

94

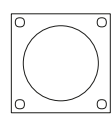

87



IP54

## QUADRA M

Luminária de teto exterior para fontes de luz de halógeno PAR20.

### QUADRA M TETO

230 V E27 75 W IP54

R10385 cinzento antracite

€ 58

R10386 cinzento prata

€ 48



G13020

140

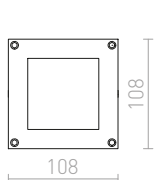
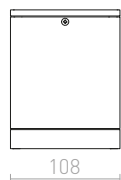

108

108

%



IP54

## ORIN

Iluminação LED quadrada para teto com abajur acetinado.

### ORIN SQ TETO

230 V LED 10 W 3000 K 800 lm Ra 80 IP54

R13628 branco/acrílico acetinado

€ 78

R13629 cinzento antracite/acrílico acetinado

€ 78

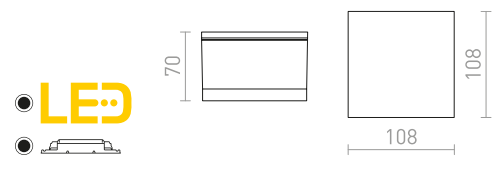

IP65

## SENZA

Plafon de LED para exterior com uma tampa inferior em vidro transparente e um acabamento que combina com o resto da luminária.

### SENZA SQ TETO

230 V LED 6 W 3000 K 580 lm Ra 80 IP65

R13624 branco/vidro transparente

€ 88

R13625 cinzento antracite/vidro transparente

€ 88

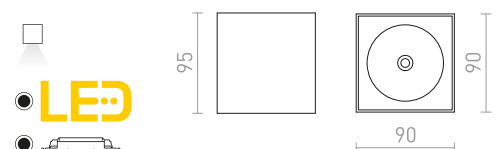





IP54



### SONNY

Plafon de teto exterior para duas fontes de luz com poupança de energia.

#### SONNY TETO

230 V E27 2x18 W IP54

**R10382** cinzento antracite

€ 88

**R10383** cinzento prata

€ 88



G13026

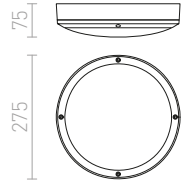

IP54



IP54



### SONYA

Plafon de alumínio circular de exterior com difusor em acrílico opala para montagem no teto ou na parede.

#### SONYA RC

230 V E27 2x18 W IP54

**R10363** cinzento prata

€ 58



G13026

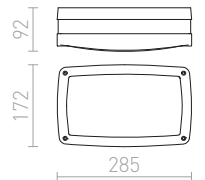

#### SONYA 30

230 V E27 2x18 W IP54

**R10361** preto

€ 98

**R10362** cinzento prata

€ 98



G13155

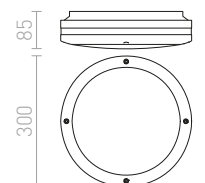



IP65

## BONO

Luz externa de alumínio fundido com LED integrado e um difusor de cor opala. Para montagem no teto ou na parede.

### BONO SUPERFÍCIE

230 V LED 4 W 3000 K 297 lm Ra 80 IP65

R11967 cinzento antracite

€ 150

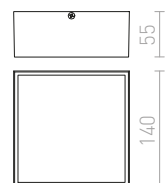
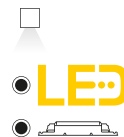



IP54



### SCOTT

Luminária LED montada em superfície para uso exterior com cobertura frontal de acrílico fosco.

#### SCOTT TETO

230 V LED 9,8 W 3000 K 637 lm Ra 80 IP54

R10552 cinzento prata

€ 68

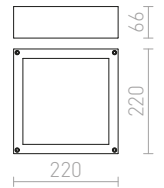
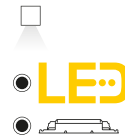

IP54

### TARIS

Luminária LED de parede/teto quadrada com cantos arredondados.

#### TARIS SQ 17 DE SUPERFÍCIE

230 V LED 8 W 3000 K 550 lm Ra 80 IP54

R12525 preto/plástico

€ 24

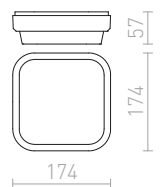

IP54

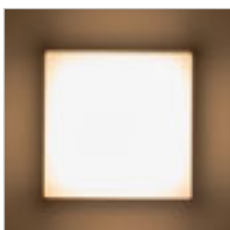

### SPECTACLE

Luz externa de alumínio fundido com LED integrado e um difusor de cor opala. Para montagem em teto ou parede.

#### SPECTACLE SUPERFÍCIE

230 V LED 5 W 3000 K 350 lm Ra 80 IP54

R11968 cinzento prata

€ 78

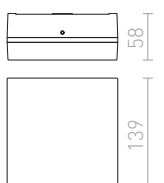

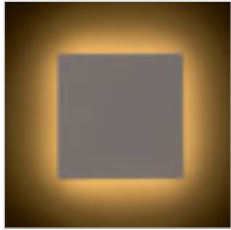

IP54

## ATHI

Luminária de parede quadrada com LED integrado para uma iluminação indireta refletindo a luz na parede. Adequada para uso interior e exterior.

### ATHI NA PAREDE

230 V LED 9,6 W 3000 K 550 lm Ra 80 IP54

R12551 branco

€ 120

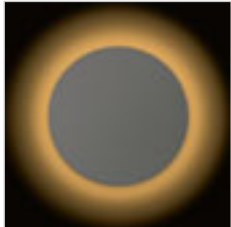
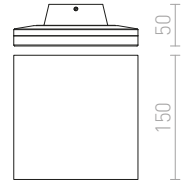
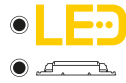

IP54

## ATLANTA

Luminária de parede circular com LED integrado para uma iluminação indireta que reflete a luz na parede. Adequada para uso interior e exterior.

### ATLANTA 13 DE SUPERFÍCIE

230 V LED 6 W 3000 K 780 lm Ra 80 IP54

R12825 branco

€ 78

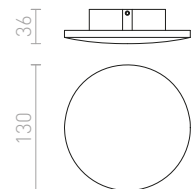



IP65

## TWIST

Iluminação LED de parede em alumínio para exterior que pode ser rodada para obter uma iluminação ascendente ou descendente.

### TWIST NA PAREDE

230 V LED 12 W 3000 K 980 lm Ra 80 IP65

R13615 branco

€ 98

R13616 cinzento antracite

€ 98

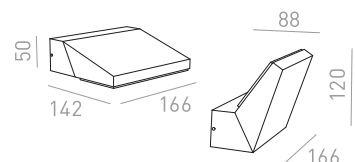





IP54

## TIRAS

Candeeiro de parede LED para exterior em alumínio lacado, com um difusor fosco para iluminação ascendente ou descendente.

### TIRAS II NA PAREDE

230 V LED 2x6 W 3000 K 371 lm Ra 80 IP54

R13569 cinzento antracite/acrílico fosco

€ 78

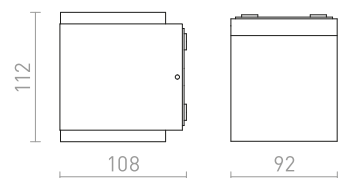

IP54

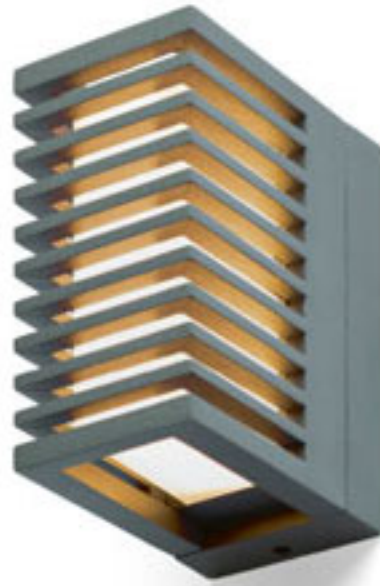

IP54

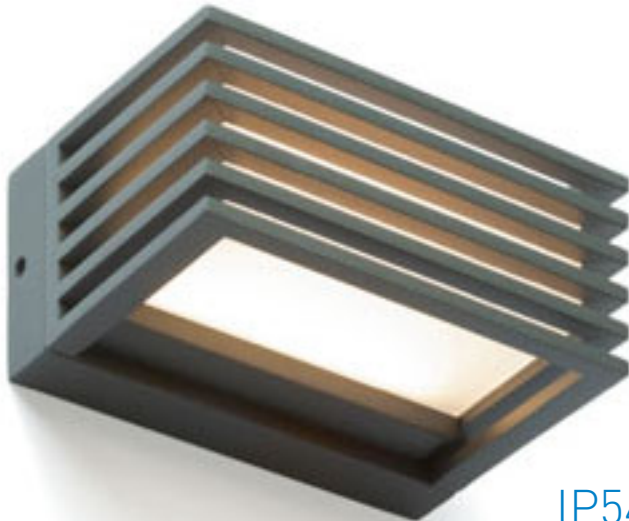

IP54

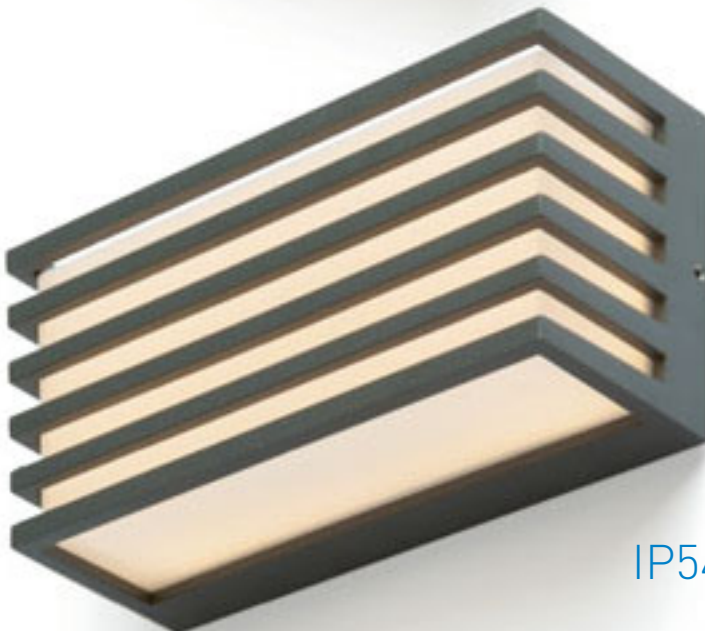

### CLAIRE

Aplique LED lacado para exterior. O corpo é em alumínio injetado.

#### CLAIRE RC NA PAREDE

230 V LED 6 W 3000 K 143 lm Ra 80 [IP54](#)

**R13563** cinzento antracite/acrílico fosco

€ 120

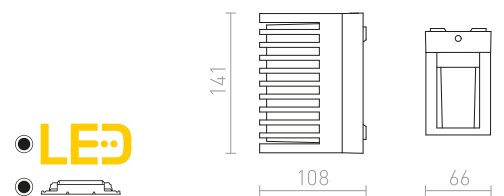

#### CLAIRE 14 NA PAREDE

230 V LED 6 W 3000 K 240 lm Ra 80 [IP54](#)

**R13564** cinzento antracite/acrílico fosco

€ 120

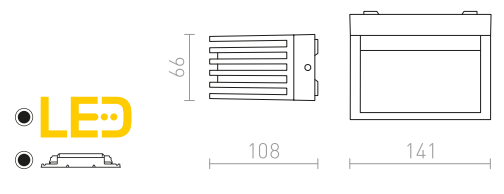

#### CLAIRE 21 NA PAREDE

230 V LED 9 W 3000 K 384 lm Ra 80 [IP54](#)

**R13565** cinzento antracite/acrílico fosco

€ 129

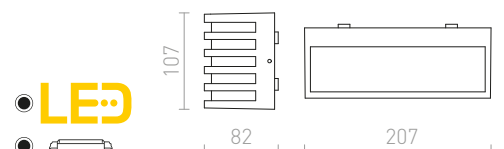

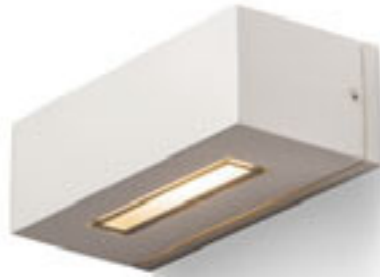

IP54



## WOOD

Luminária de exterior bidirecional. Um dos lados da luminária tem vidro claro com moldura preta. O outro lado tem uma cobertura de vidro fosco com moldura preta.

### WOOD NA PAREDE

230 V R7s 78mm 48 W IP54

R10437 branco

€ 48

R10438 cinzento prata

€ 48

R10439 cinzento antracite

€ 58

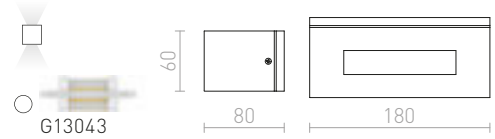

IP54

## TORINO

Luminária LED retangular de parede com iluminação bidirecional.

### TORINO NA PAREDE

230 V LED 2x5 W 3000 K 550 lm Ra 80 IP54

R12573 branco

€ 129

R12574 preto

€ 129

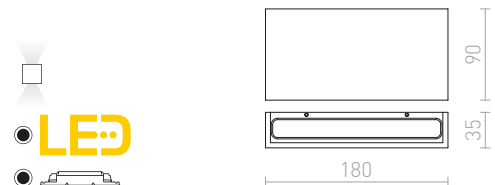



IP65

### SAMPO

Iluminação externa LED em alumínio de parede com forma retangular com iluminação assimétrica descendente.

#### SAMPO NA PAREDE

230 V LED 9 W 3000 K 650 lm Ra 80 IP65

R13619 cinzento antracite

€ 98

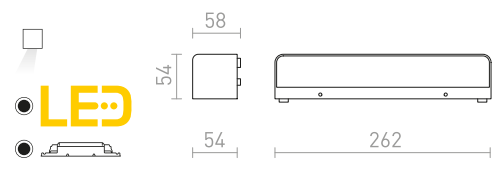

IP65

### CAMARGUE

Aplique LED retangular para iluminação descendente.

#### CAMARGUE NA PAREDE

230 V LED 6 W 3000 K 550 lm Ra 80 IP65

R13527 cinzento prata/vidro acetinado

€ 129

R13641 cinzento antracite/vidro acetinado

€ 129

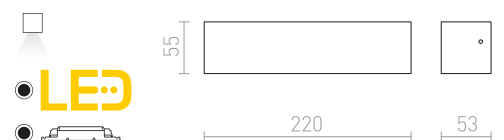

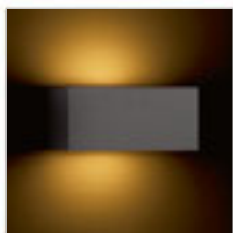

IP54



IP54

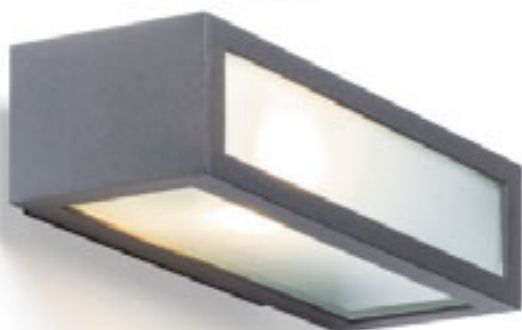

IP44

## DURANT

Luminária retangular de parede para exterior com iluminação bidirecional para fontes de luz economizadoras de energia E27.

### DURANT UP - DOWN NA PAREDE

230 V E27 18 W IP54

R12559 cinzento antracite

€ 120

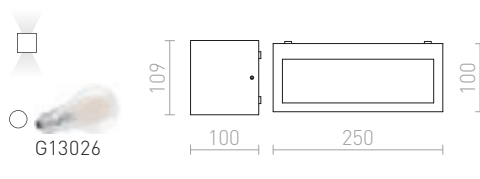

## DURANT

Luminária de parede exterior com fontes de luz economizadoras de energia E27 para iluminação ambiente.

### DURANT NA PAREDE

230 V E27 18 W IP54

R12568 cinzento prata

€ 88

R12569 cinzento antracite

€ 98

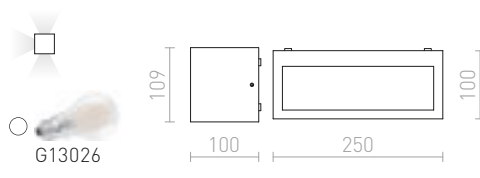

## GINO

Luminária de parede para uso exterior com coberturas de vidro acetinado. Dimensões da base A/L/C 2/6/20cm.

### GINO NA PAREDE

230 V E27 18 W IP44

R10387 cinzento antracite

€ 98

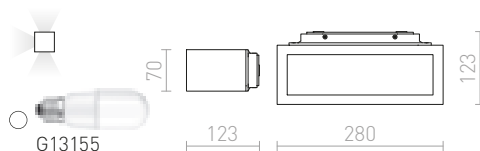







IP54

**DELTA**

Luminária de parede exterior adequada para terraços e entradas, para fontes de luz de baixo consumo energético GX53 ou E27.

**DELTA 145 DE SUPERFÍCIE**

230 V GX53 9 W IP54

R12563 cinzento antracite

€ 48

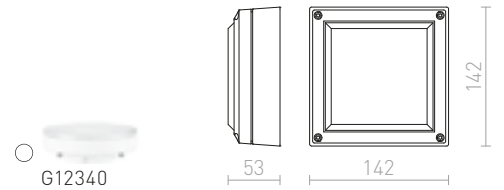

IP54

**DELTA 215 DE SUPERFÍCIE**

230 V E27 18 W IP54

R12564 cinzento antracite

€ 88

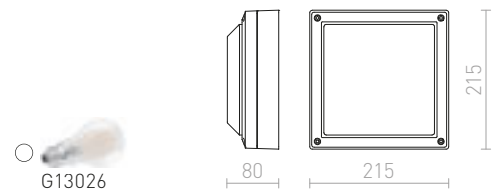

IP54

**DELTA**

Luminária de parede exterior adequada para terraços e entradas, para fontes de luz de baixo consumo energético GX53 ou E27.

**DELTA 145 NA PAREDE**

230 V GX53 9 W IP54

R12565 cinzento antracite

€ 48

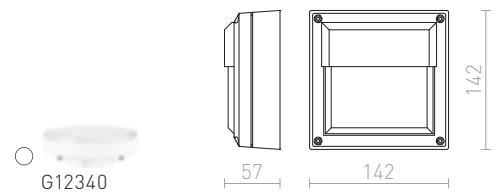

IP54

**DELTA 215 NA PAREDE**

230 V E27 18 W IP54

R12566 cinzento antracite

€ 88

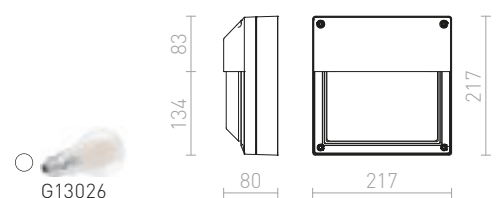



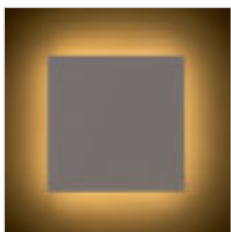

IP54

## ATHI

Luminária de parede quadrada com LED integrado para uma iluminação indireta refletindo a luz na parede. Adequada para uso interior e exterior.

### ATHI NA PAREDE

230 V LED 9,6 W 3000 K 550 lm Ra 80 IP54

R12551 branco

€ 120

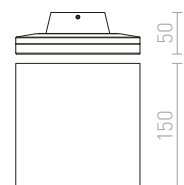



IP54

### DELTA

Luminária de parede exterior adequada para iluminação geral, para fontes de luz economizadoras de energia E27.

#### DELTA RC NA PAREDE

230 V E27 18 W IP54

R12567 cinzento antracite

€ 78 %

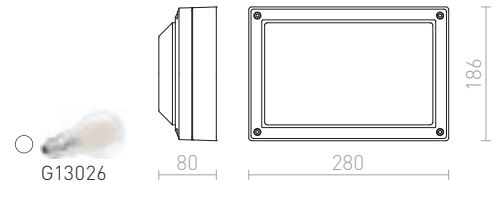

IP44

### CHICAGO

Luminária exterior feita de alumínio fundido com difusor acrílico de cor opala. Para fontes de luz economizadoras de energia E27.

#### CHICAGO NA PAREDE

230 V E27 18 W IP44

R12018 cinzento antracite

€ 68

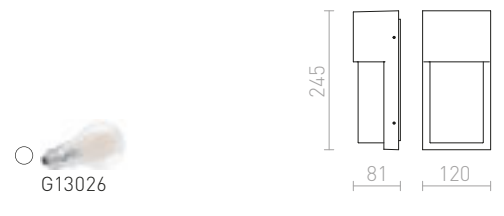

IP54

### VERIA

Aplique fino de exterior com LED integrado.

#### VERIA NA PAREDE

230 V LED 6 W  $\angle 116^\circ$  3000 K 629 lm Ra 80 IP54

R11169 cinzento prata

€ 120 %

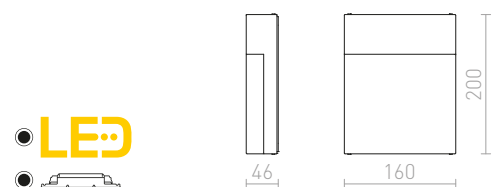





IP54

### HIDE

Aplique de exterior com casquilho E27. Iluminação suave adequada para terraços e entradas.

#### HIDE RC NA PAREDE

230 V E27 18 W IP54

R12561 cinzento antracite

€ 98

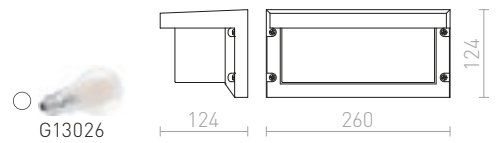

IP44

#### HIDE SQ NA PAREDE

230 V E27 13 W IP44

R12560 cinzento antracite

€ 88

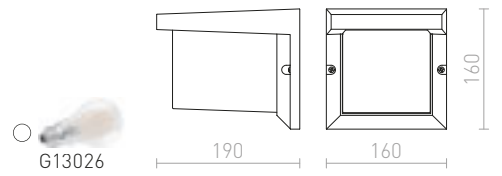

IP65

### ANDANTE

Aplique de teto com LED embutido, adequado para iluminação de terraços ou entradas domésticas.

#### ANDANTE NA PAREDE

230 V LED 21 W 3000 K 1200 lm Ra 80 IP65

R13504 cinzento antracite/acrílico fosco

€ 138

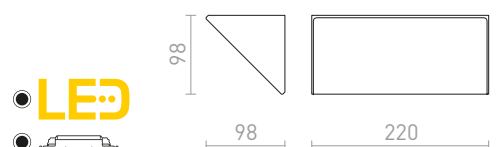



IP54

## TAPA

Luminária de parede retangular para exterior em metal lacado, bidirecional LED.

### TAPA NA PAREDE

230 V LED 6 W 3000 K 277 lm Ra 80 IP54

R13562 branco

€ 68 →

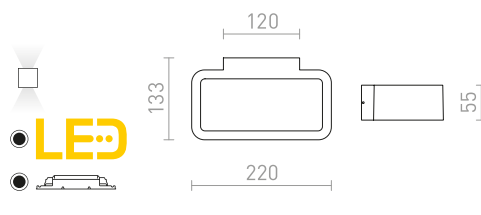

IP54

## VECINO

Aplique de exterior em alumínio fundido com cobertura inferior de opala.

### VECINO NA PAREDE

230 V LED 5 W 3000 K 330 lm Ra 80 IP54

R10351 cinzento prata

€ 58 %

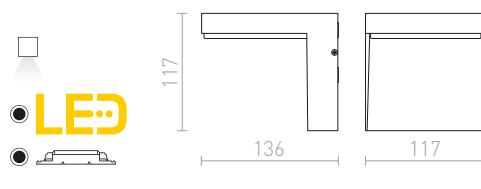

IP65

## CHLOE

Aplique retangular em aço inoxidável, para iluminação indireta de uso interior ou exterior.

### CHLOE NA PAREDE

230 V LED 9 W 3000 K 800 lm Ra 80 IP65

R11752 aço inoxidável

€ 120 →



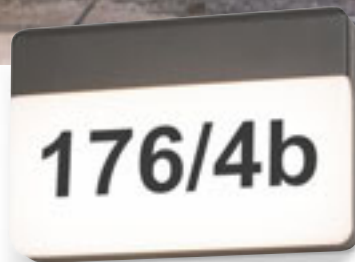
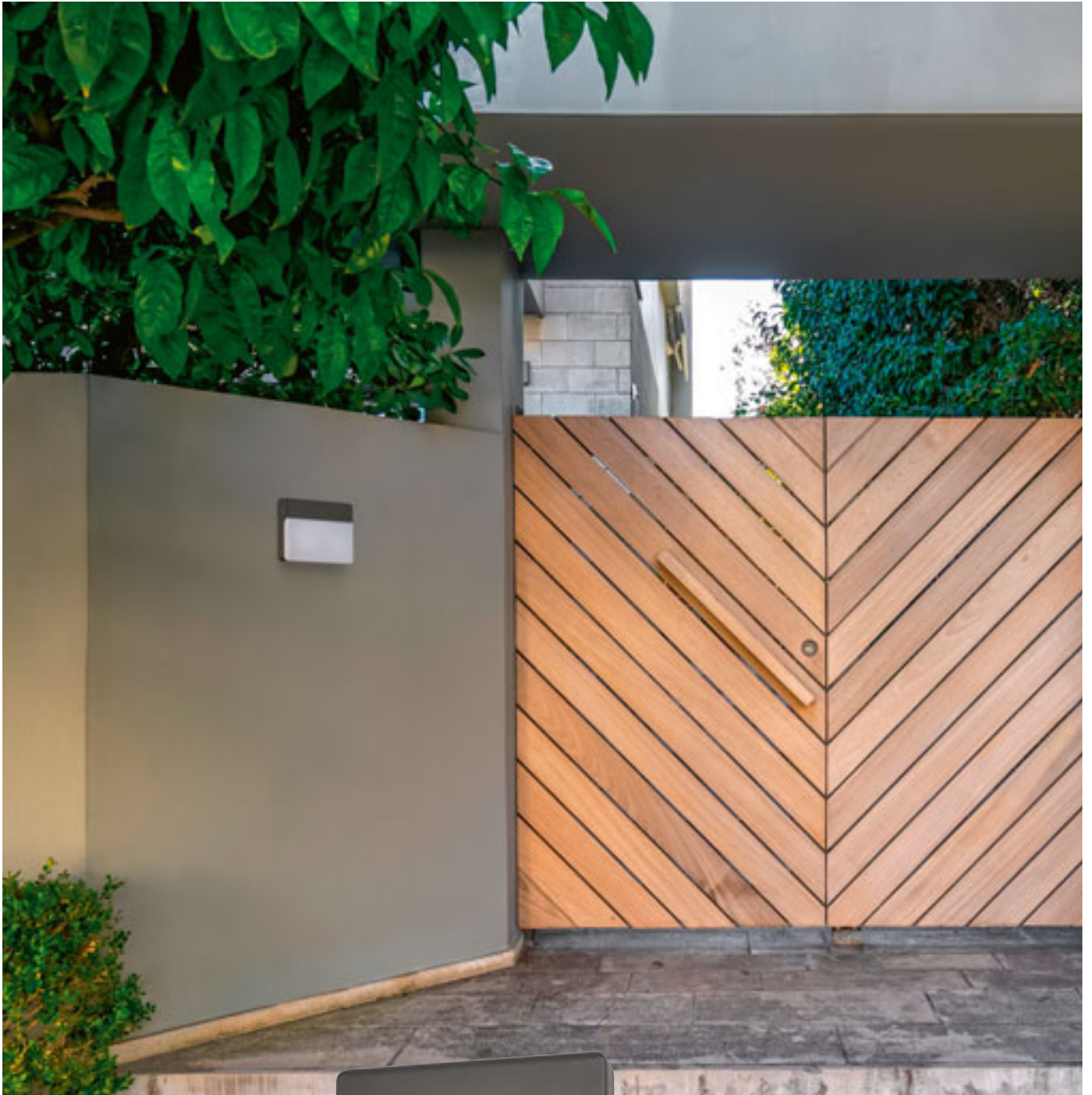

IP65

### GAVIN

Candeiro de parede LED plano para exterior adequado para iluminar portas de entrada, corredores ou escadas. A luminária também é adequada para afixar números ou outros símbolos (não fornecidos).

#### GAVIN NA PAREDE

230 V LED 13 W 3000 K 650 lm Ra 80 IP65

R13756 cinzento antracite/acrílico fosco

€ 120

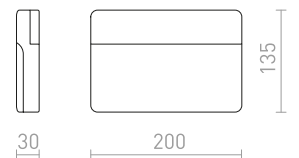



IP65

### COMODO

Foco com LED embutido para iluminação descendente.

#### COMODO NA PAREDE

230 V LED 20 W 3000 K 940 lm Ra 80 IP65

R13512 cinzento antracite

€ 150

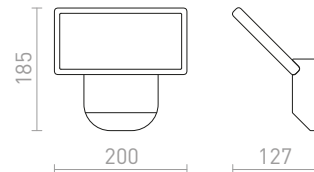

IP65

### VIRGO

Aplique LED de exterior com cobertura de cor opala. Para iluminação descendente.

#### VIRGO NA PAREDE

230 V LED 9 W 3000 K 800 lm Ra 80 IP65

R11946 cinzento antracite

€ 88

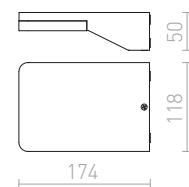
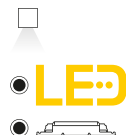



IP65

### TWIST

Iluminação LED de parede em alumínio para exterior que pode ser rodada para obter uma iluminação ascendente ou descendente.

#### TWIST NA PAREDE

230 V LED 12 W 3000 K 980 lm Ra 80 IP65

R13615 branco

€ 98

R13616 cinzento antracite

€ 98

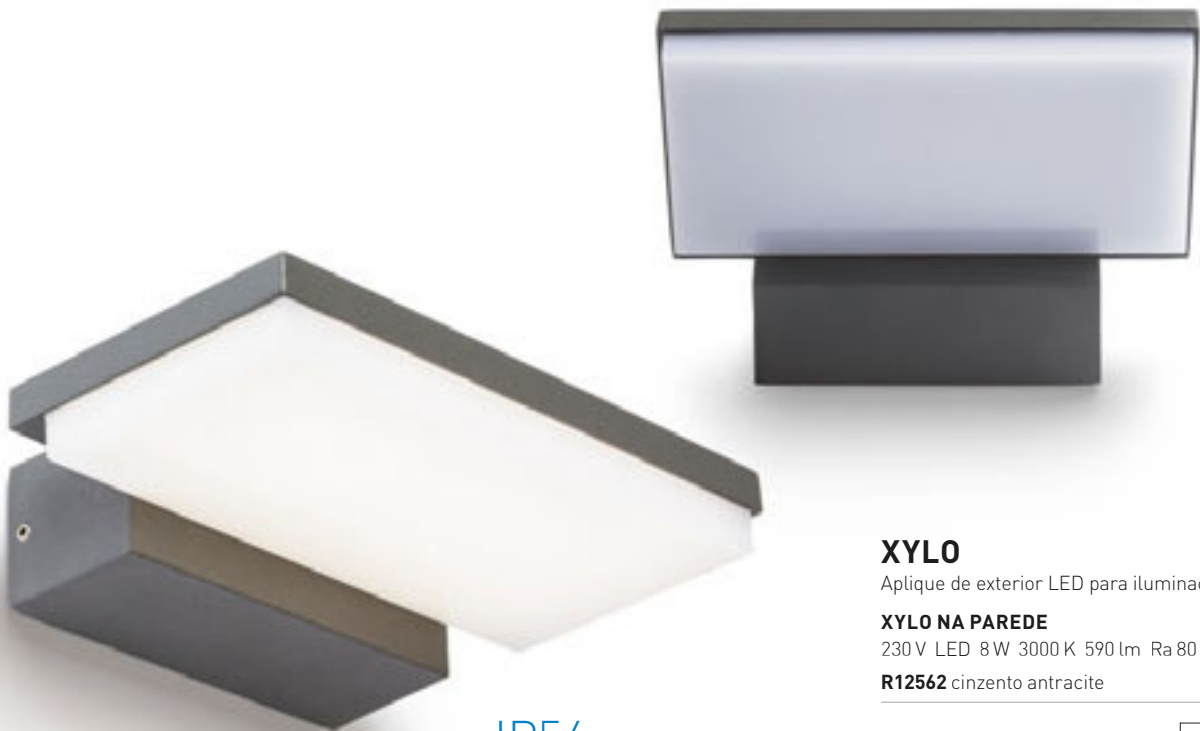
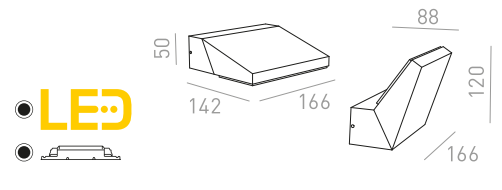

IP54

### XYLO

Aplique de exterior LED para iluminação descendente.

#### XYLO NA PAREDE

230 V LED 8 W 3000 K 590 lm Ra 80 IP54

R12562 cinzento antracite

€ 120

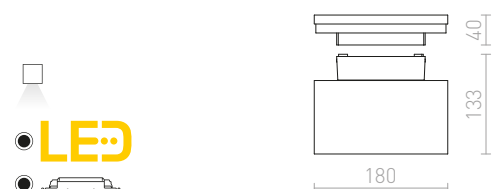





## MIZZI

Aplique de exterior em alumínio fundido com 12W LED de alto brilho. Driver incluído.

### MIZZI SQ I NA PAREDE

230 V LED 12 W  $\angle 44^\circ$  3000 K 846 lm Ra 80 IP54

R11964 cinzento antracite

€ 129 %

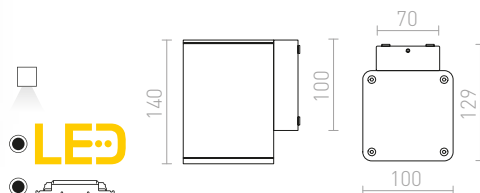

IP44

## TELO

Luminária de parede bidirecional para exterior com painel de vidro transparente.

### TELO NA PAREDE

230 V G9 40 W IP44

R10554 cinzento antracite

€ 68

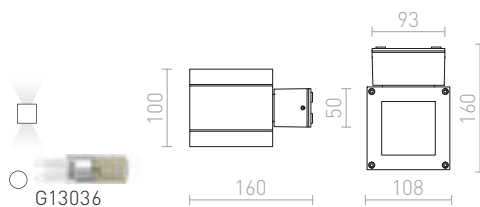

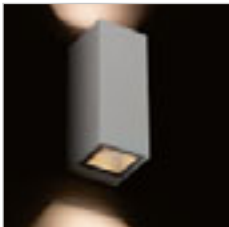

IP44

## DESMOND

Candeeiro de parede em alumínio para exterior com iluminação bidirecional para duas fontes de luz LED com casquilho GU10.

### DESMOND II NA PAREDE

230 V GU10 2x35 W IP44

R13609 branco

€ 68

R13610 cinzento prata

€ 68

R13611 cinzento antracite

€ 68

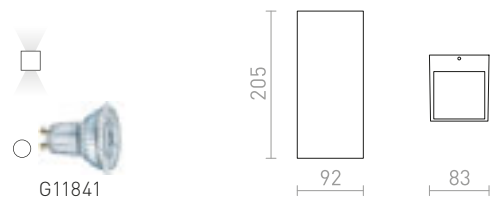

IP54

## CABOX

Aplique de exterior com casquilho E27 e iluminação bidirecional.

### CABOX II NA PAREDE

230 V E27 70 W IP54

R10384 cinzento antracite

€ 88

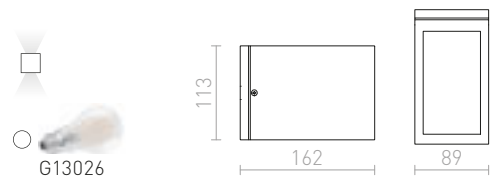



IP65



IP65

## TITO

Luminária de parede LED para iluminação direcional com possibilidade de configurar o feixe de luz. Regulação da intensidade da luz TRIAC.

### TITO R DIMM NA PAREDE

230 V LED 2x3 W 3000 K 500 lm Ra 80 IP65

R13736 branco

€ 88

R13737 preto

€ 88

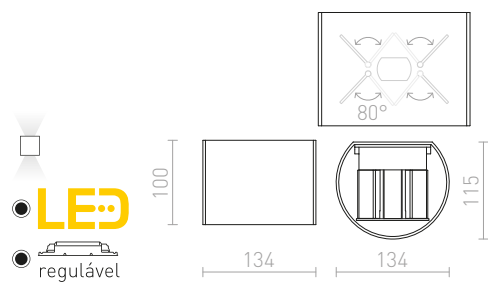

LED



regulável

### TITO SQ DIMM NA PAREDE

230 V LED 2x3 W 3000 K 500 lm Ra 80 IP65

R13738 branco

€ 88

R13739 preto

€ 88

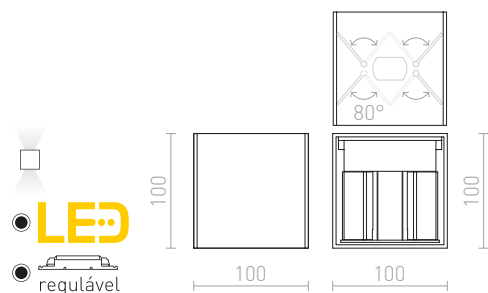

LED



regulável



IP54

### CARRE

Luminária de parede angular com LED integrado para iluminação bidirecional, com possibilidade de configurar feixe de luz.

#### CARRE NA PAREDE

230 V LED 2x3 W 3000 K 200 lm Ra 80 IP54

R12556 branco

€ 88

R12557 cinzento antracite

€ 88

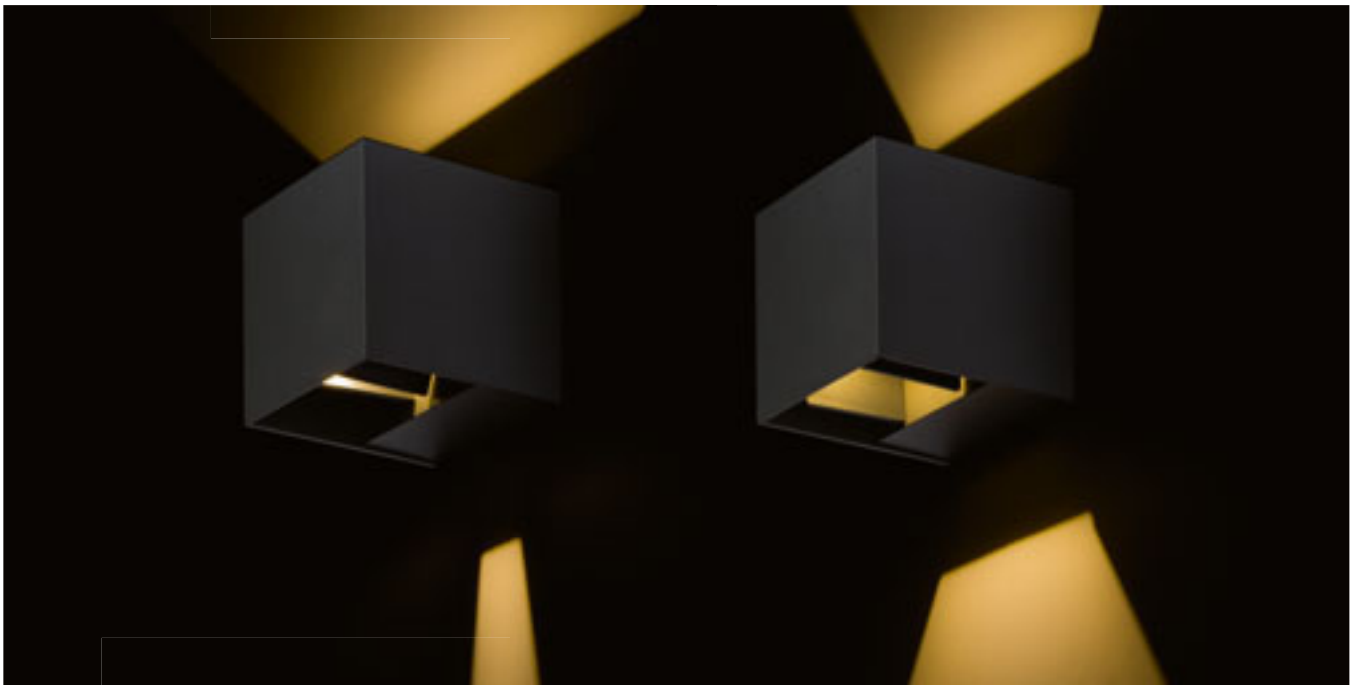
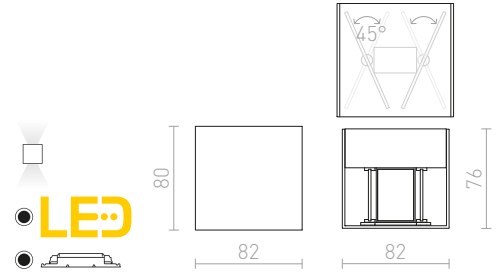

IP54

### TITO

Luminária de parede LED para iluminação bidirecional com possibilidade de configurar o feixe de luz.

#### TITO SQ NA PAREDE

230 V LED 6 W 3000 K 500 lm Ra 80 IP54

R12601 alumínio escovado

€ 78

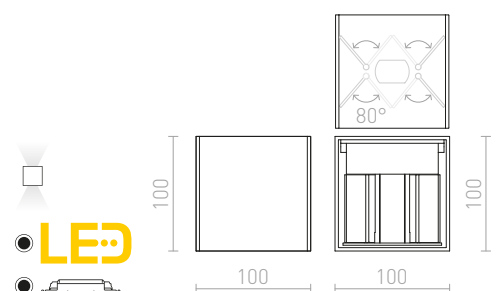





## GRANITA

Candeeiro de parede exterior em cimento, para fontes de luz LED com casquilho GU10.

### GRANITA II NA PAREDE

230 V LED GU10 2x5 W IP65

R13792 cimento/granito claro

€ 120

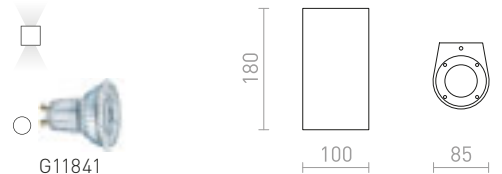

IP65



## KANE

Candeeiro em cimento de parede para exterior, fontes de luz LED com casquilho GU10.

### KANE I NA PAREDE

230 V LED GU10 5 W IP65

R13793 cimento/granito escuro

€ 88

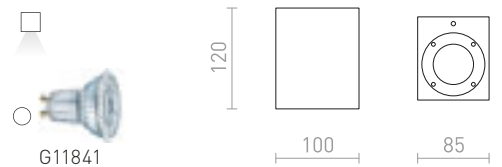

IP65



### KANE II NA PAREDE

230 V LED GU10 2x5 W IP65

R13794 cimento/granito escuro

€ 120

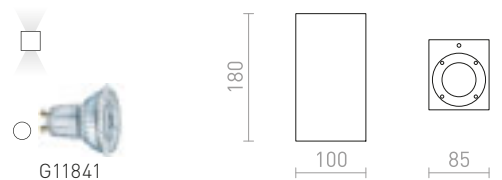



IP54



IP65

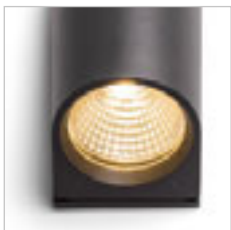

## PIA

Aplique de exterior LED bidirecional em alumínio fundido.

### PIA NA PAREDE

230 V LED 2x3 W 3000 K 270 lm Ra 80 IP54

R12010 cinzento antracite

€ 68

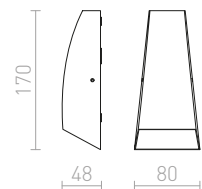
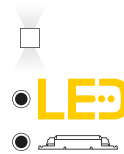

## ZAZA

Luminária exterior de parede com cobertura transparente.

### ZAZA NA PAREDE

230 V LED 3,3 W 3000 K 250 lm Ra 80 IP65

R10398 cinzento antracite

€ 78 %

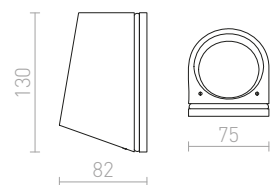
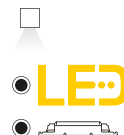

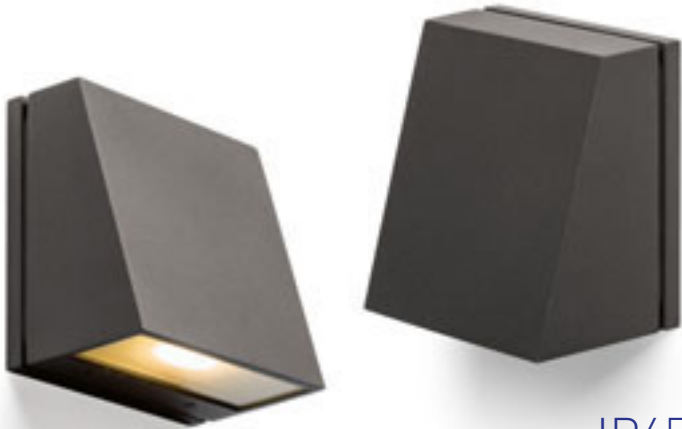

IP65

### GIGI

Aplique de exterior com proteção de vidro.

#### GIGI NA PAREDE

230 V LED 3,3W 3000 K 250 lm Ra 80 IP65

R10399 cinzento antracite

€ 98

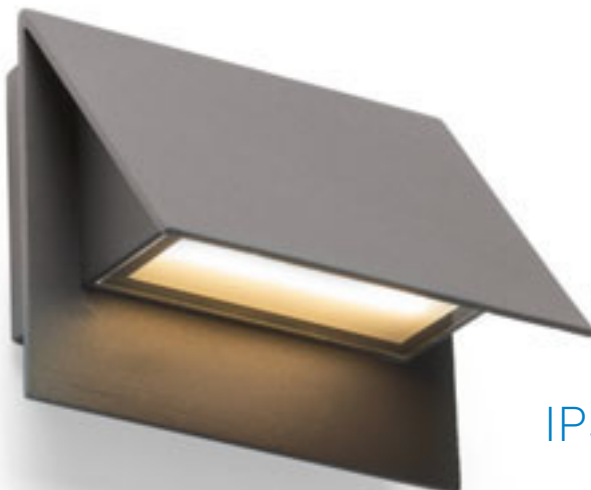
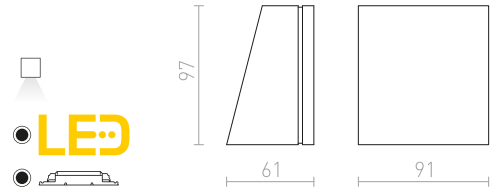

IP54

### GERI

Luminária LED em alumínio para exterior com iluminação embutida.

#### GERI NA PAREDE

230 V LED 5W 3000 K 211 lm Ra 80 IP54

R13561 cinzento antracite

€ 88

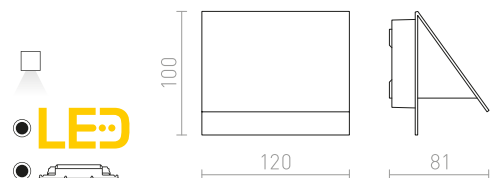



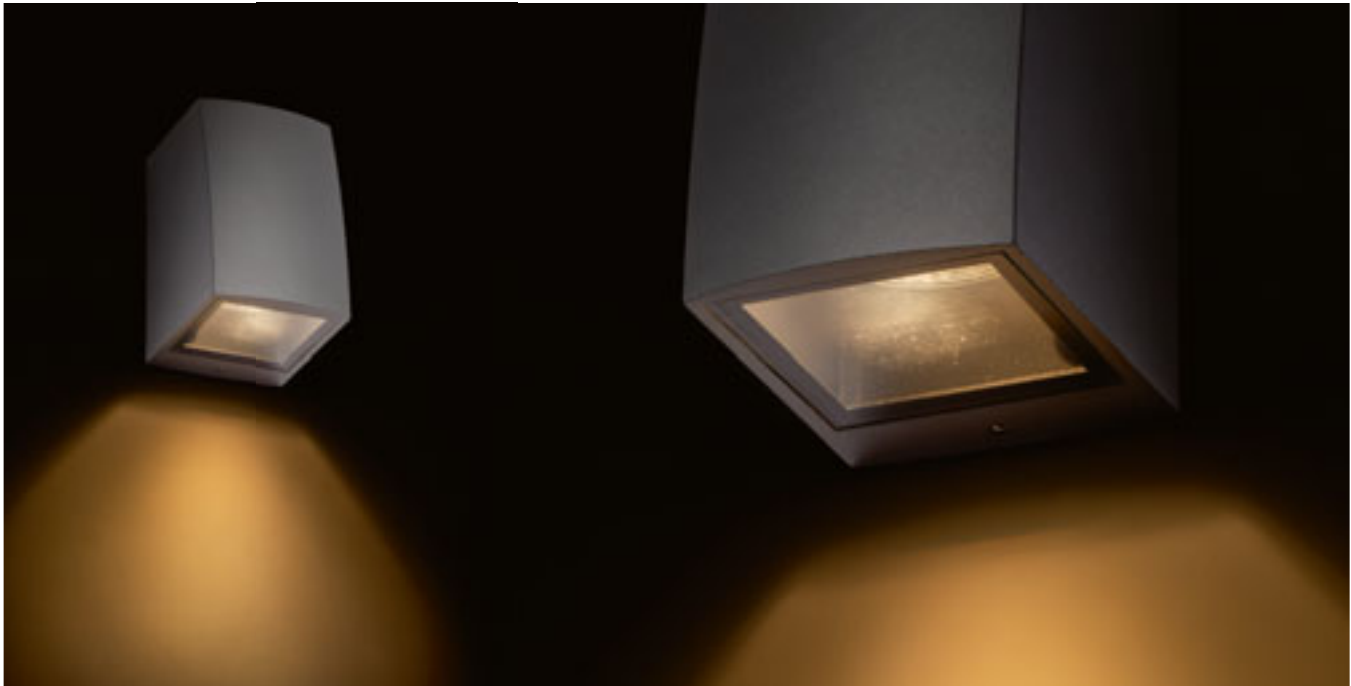

IP54

## SELMA

Foco de alumínio para exterior com um casquilho GU10.

**SELMA NA PAREDE**  
230 V GU10 35 W IP54

**R13513** branco

€ 35

**R13514** cinzento prata

€ 35

**R13515** cinzento antracite

€ 35

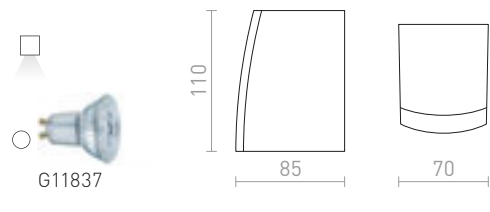

IP54

## SIV

Candeeiro de teto redondo com LED embutido e iluminação descendente. Adequado para corredores.

**SIV SUPERFÍCIE**

230 V LED 6 W  $\angle 120^\circ$  3000 K 360 lm Ra80 IP54

**R13502** cinzento antracite

€ 78

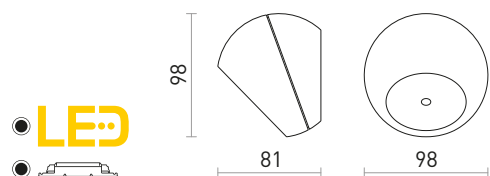



IP54

### BOURDON

Candeiro de parede exterior com suporte para fontes de luz GU10. O corpo é em alumínio fundido pintado.

#### BOURDON NA PAREDE

230 V GU10 35 W IP54

R13559 cinzento antracite

€ 48

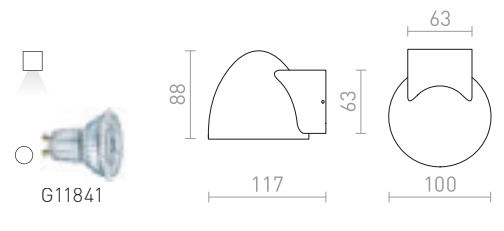

IP54

### PIPER

Aplique LED tubular para exterior com iluminação embutida.

#### PIPER NA PAREDE

230 V LED 6 W 3000 K 489 lm Ra 80 IP54

R13560 cinzento antracite

€ 78

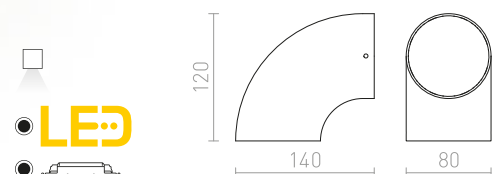
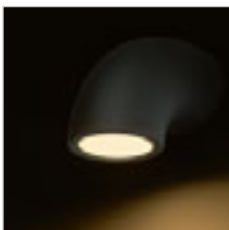



IP54



IP54



## ZACK

Luminária LED de parede exterior em alumínio pressurizado.

### ZACK II

230 V LED 2x3 W  $\angle 58^\circ$  3000 K 315 lm Ra 80 IP54

R12022 cinzento antracite

€ 78

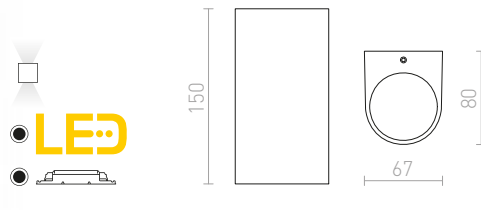

### ZACK I

230 V LED 3 W  $\angle 58^\circ$  3000 K 176 lm Ra 80 IP54

R12027 cinzento antracite

€ 58

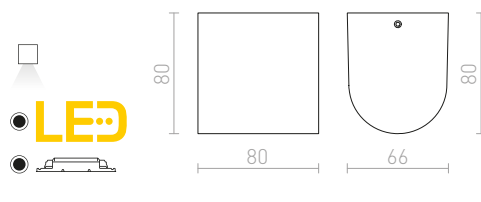

IP54

## MIDZACK

Aplique arredondado com LED integrado para iluminação bidirecional.

### MIDZACK NA PAREDE

230 V LED 2x3 W 3000 K 480 lm Ra 80 IP54

R12585 branco

€ 88

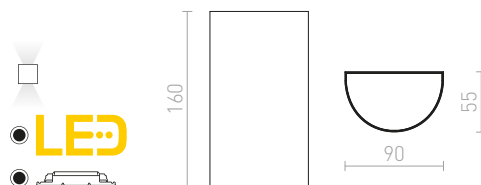



IP65

## BEJA

Lâmpada bidirecional de parede exterior em alumínio fundido. A luminária está equipada com LEDs de alta potência.

### BEJA II NA PAREDE

230 V LED 2x9 W  $\angle 24^\circ$  3000 K 670 lm Ra 80 IP65

R13757 cinzento antracite

€ 138

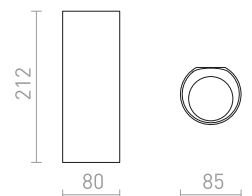
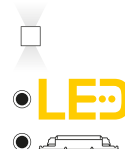



IP54

### KUBI

Luminária LED de parede para exteriores em alumínio pressurizado.

#### KUBI I

230 V LED 3 W  $\angle 56^\circ$  3000 K 176 lm Ra 80 IP54

R12021 cinzento antracite

€ 58

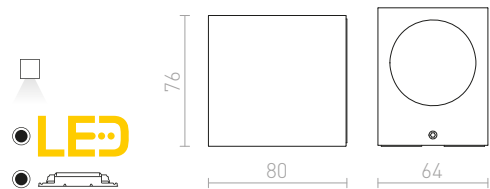

IP54

#### KUBI II

230 V LED 2x3 W  $\angle 56^\circ$  3000 K 315 lm Ra 80 IP54

R12028 cinzento antracite

€ 68

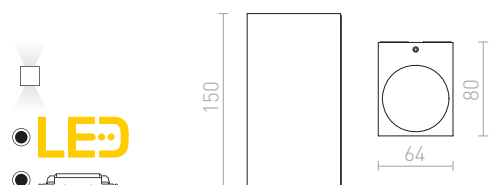

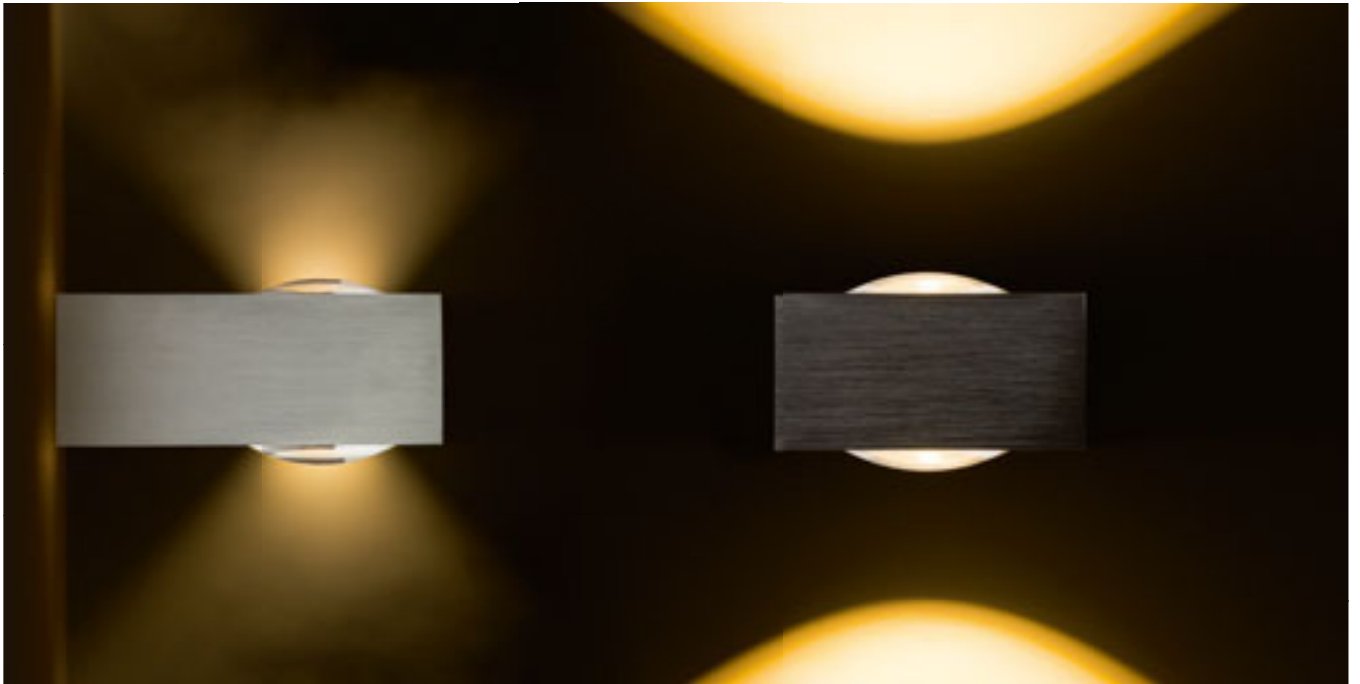

IP54

### KORSO

Aplique com LED integrado para interiores e exteriores. Feito de alumínio com acabamento anodizado natural ou preto escovado.

#### KORSO II NA PAREDE

230 V LED 2x3 W  $\angle 120^\circ$  3000 K 780 lm Ra 80 IP54

R12831 alumínio escovado € 68 %

R12832 anodizado negro € 68 %

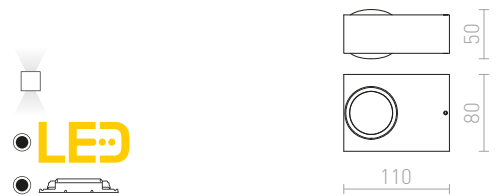

IP54

#### KORSO I NA PAREDE

230 V LED 5 W  $\angle 120^\circ$  3000 K 390 lm Ra 80 IP54

R12829 alumínio escovado € 58 %

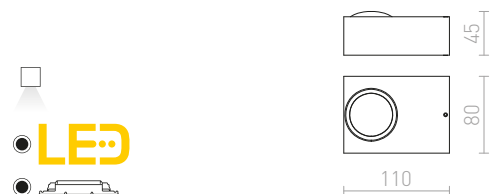

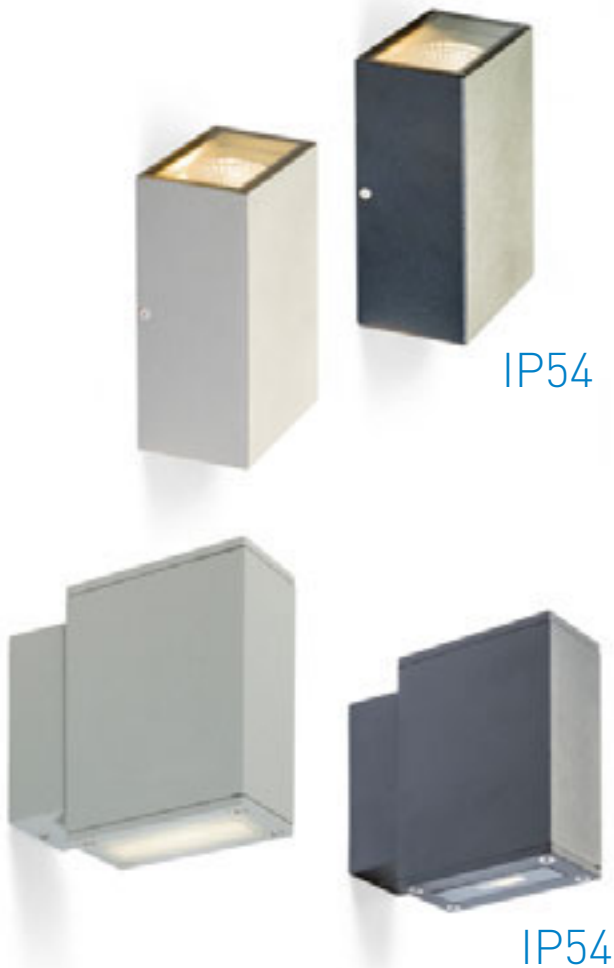

## DIXIE

Luminária de parede para exterior com LED integrado, de alumínio fundido para iluminação bidirecional.

### DIXIE 10x16 NA PAREDE

230V LED 2x5W  $\angle 84^\circ$  3000 K 550lm Ra 80 IP54

R10352 branco

€ 68

%

R10353 preto

€ 68

%

R10354 cinzento prata

€ 68

%



LED



160

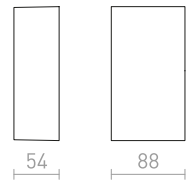

54

88

### DIXIE 4x12 NA PAREDE

230V/700mA LED 2x3W  $\angle 48^\circ$  3000 K 360lm Ra 80 IP54

R10355 preto

€ 98

→

R10356 cinzento prata

€ 48

%



LED



120

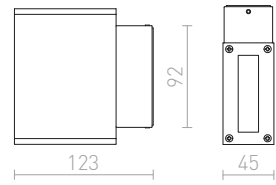

123

92

45

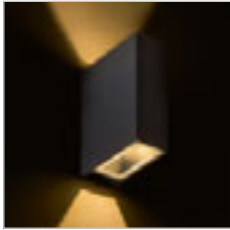

IP54

### UKKO

Aplique retangular para exteriores com LED integrado, para iluminação bidirecional.

#### UKKO NA PAREDE

230 V LED 2x3 W  $\angle 55^\circ$  3000 K 180 lm Ra 80 IP54

R12555 preto

€ 120

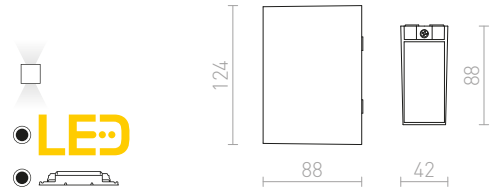

IP54

### PEKKO

Aplique retangular para exteriores com LED integrado para iluminação unidirecional.

#### PEKKO NA PAREDE

230 V LED 3 W  $\angle 67^\circ$  3000 K 86 lm Ra 80 IP54

R12552 branco

€ 78

R12553 preto

€ 78

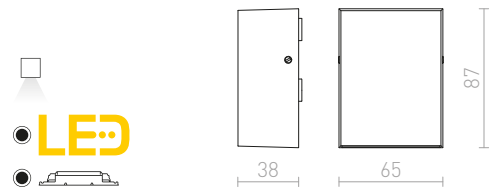

IP54

### NICK

Aplique com LED integrado e iluminação bidirecional adequado para interiores e exteriores.

#### NICK II NA PAREDE

230 V LED 2x3 W  $\angle 10^\circ$  3000 K 780 lm Ra 80 IP54

R12827 alumínio escovado

€ 68

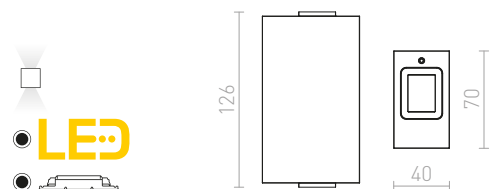





IP54

## ZANE

Tubo LED minimalista montado em uma base quadrada com iluminação bidirecional adequado para uso externo.

### ZANE NA PAREDE

230 V LED 2x3 W  $\angle 60^\circ$  3000 K 300 lm Ra 80 IP54

R12960 níquel mate

€ 58 %

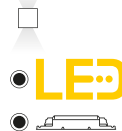
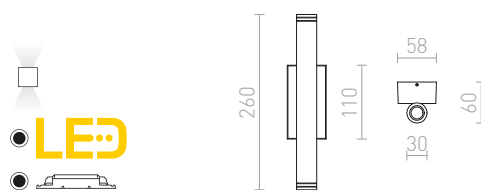

IP54

## MICO

Aplique de alumínio fundido com foco fixo para iluminação unidirecional.

### MICO I EXTERIOR

230 V GU10 35 W IP54

R10170 alumínio

€ 58 %

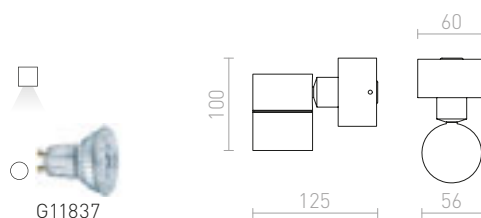



IP54



IP54

## MOIRE

Aplique de alumínio natural com coberturas de vidro.

**MOIRE I EXTERIOR**  
230 V GU10 35 W IP54

R10133 alumínio

€ 48 %

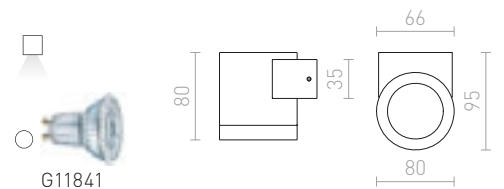

**MOIRE II EXTERIOR**  
230 V G9 25 W IP54

R10132 alumínio

€ 68 %

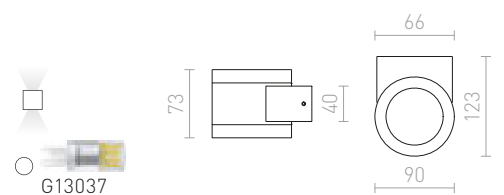

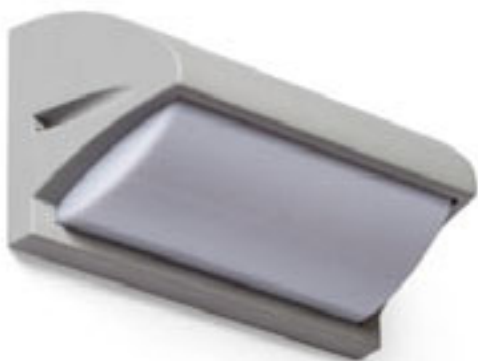

IP54



## MORA

Luminária de parede para uso exterior com iluminação suave, adequada para terraços e entradas de habitação, com casquilho E27.

### MORA NA PAREDE

230 V E27 18 W IP54

R12571 cinzento prata

€ 48

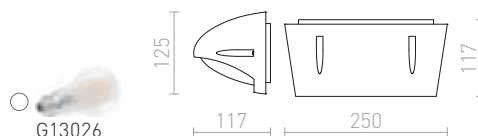

IP54



## LESA

Luminária de alumínio pressurizado para exterior montada em parede, disponível em três cores. Uma placa de cobertura de metal está incluída, se a iluminação descendente for tudo o que é necessário.

### LESA NA PAREDE

230 V E27 26 W IP54

R10364 preto

€ 88

R10365 branco

€ 88

R10366 cinzento prata

€ 88

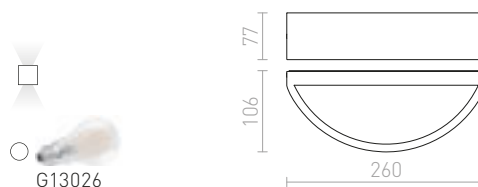



IP54



IP54

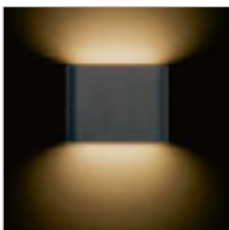

## CHOIX

Aplique LED bidirecional de exterior em alumínio fundido.

### CHOIX 114 NA PAREDE

230 V LED 2x3 W 3000 K 318 lm Ra 80 IP54

R12012 cinzento antracite

€ 68



LED

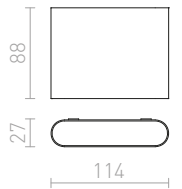

### CHOIX 175 NA PAREDE

230 V LED 10 W 3000 K 660 lm Ra 80 IP54

R12691 cinzento antracite

€ 78



LED

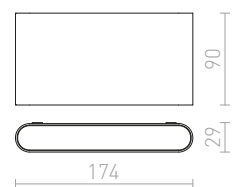



IP65



### FOX

Foco de LED ajustável de uso em exterior com cobertura de vidro transparente para montagem em parede. Para instalação em jardim, é possível montar com estaca no solo (R11755).

#### FOX REFLETOR EXTERIOR

230 V LED 9 W  $\angle 120^\circ$  3000 K 900 lm Ra 80 IP65

R11753 cinzento antracite

€ 178

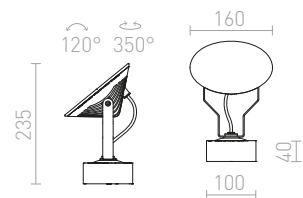

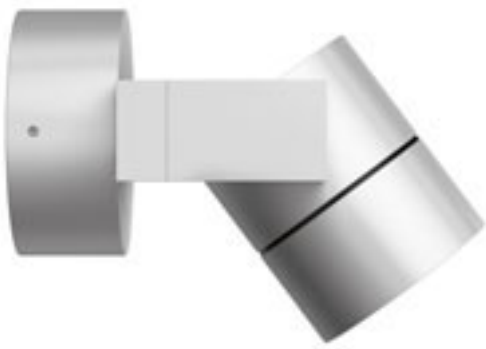

IP44

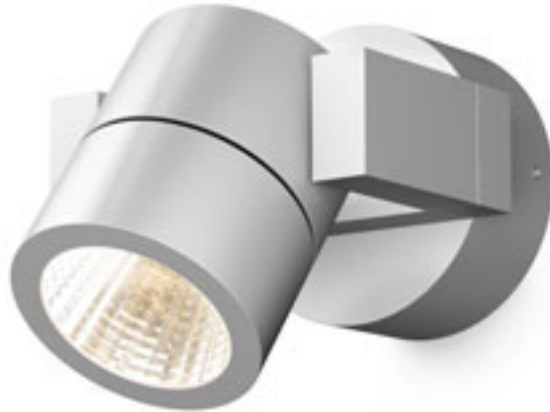

### ORIT

Foco inclinável em alumínio para exterior equipado com LED de 6W. Luz inclinável em apenas um eixo.

#### ORIT NA PAREDE

230 V LED 6 W  $\angle 80^\circ$  3000 K 315 lm Ra 80 IP44

R12033 alumínio

€ 78 ➔

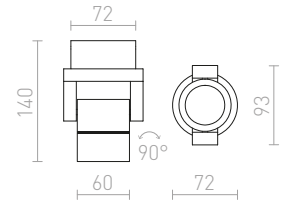

IP54

### DIREZZA

Foco exterior com refletor que pode inclinar soltando um parafuso entre o refletor e a base.

#### DIREZZA NA PAREDE

230 V GU10 35 W IP54

R10388 cinzento prata

€ 58

R10432 cinzento antracite

€ 58



G11837

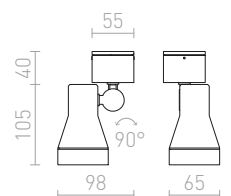





IP54

### BORA

Foco LED quadrado de exterior para montagem em parede.

#### BORA NA PAREDE

230 V LED 6 W  $\angle 44^\circ$  3000 K 355 lm Ra 80 IP54

R12578 cinzento antracite

€ 98

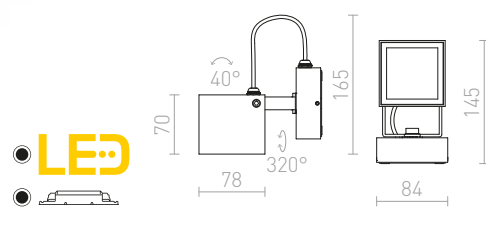

IP54

### PONTA

Holofote plano e preto com LED integrado. O cabo é fornecido sem ficha.

#### PONTA COM SENSOR

230 V LED 30 W  $\angle 120^\circ$  3000 K 2700 lm Ra 80 IP54

R12982 preto

€ 68

%

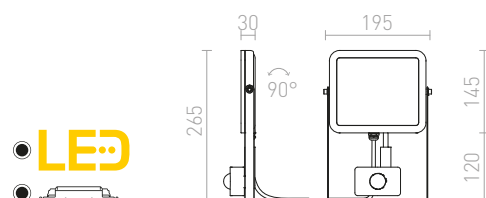





IP65

## BLUESTAR

Foco externo de alumínio com espigão para fonte de luz LED com casquilho GU10, moldura frontal em aço inoxidável. Inclui cabo principal de 1m, sem ficha incluída.

### BLUESTAR COM ESPIGÃO

230 V GU10 35 W IP65

R13630 cinzento antracite

€ 78

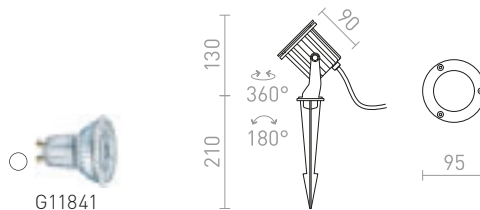

IP65

## GUN

Foco projetor LED de exterior com estaca no solo. Inclui um cabo principal de 1m, sem ficha incluída.

### GUN COM ESPIGÃO

230 V LED 3x1 W  $\angle 30^\circ$  3000 K 210 lm Ra 80 IP65

R10530 preto

€ 48





### DIREZZA

Foco exterior com refletor que pode inclinar soltando um parafuso entre o refletor e a base.

#### DIREZZA COM ESPIGÃO

230 V GU10 35 W IP54

R10427 cinzento prata

€ 68

R10431 cinzento antracite

€ 68

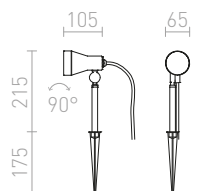

### CORDOBA

Foco de exterior sobre estaca com fonte de luz GU10. Fornecido com um cabo de 1m, sem ficha incluída.

#### CORDOBA COM ESPIGÃO

230 V GU10 35 W IP54

R12579 cinzento antracite

€ 68

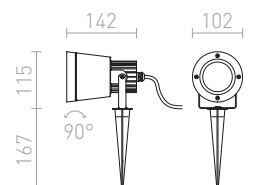



IP65

### LORCA

Mini foco LED para exterior com espigão para o solo. Inclui cabo de alimentação de 1m, sem ficha incluída.

#### LORCA COM ESPIGÃO

230 V LED 5W 3000 K 316 lm Ra 80 IP65

R13568 cinzento antracite

€ 120

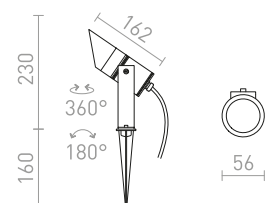



IP65

### GARY

Foco LED exterior sobre estaca no chão. Inclui cabo principal de 1m, sem ficha incluída.

#### GARY LED COM ESPIGÃO

230 V LED 10 W  $\angle 45^\circ$  3000 K 900 lm Ra 80 IP65

R10527 cinzento

€ 88

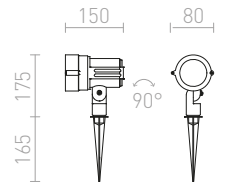

IP54

### BORA

Foco LED quadrado de exterior. Inclui cabo de ligação de 1m, sem ficha incluída.

#### BORA COM ESPIGÃO

230 V LED 6 W  $\angle 50^\circ$  3000 K 340 lm Ra 80 IP54

R12025 cinzento antracite

€ 98

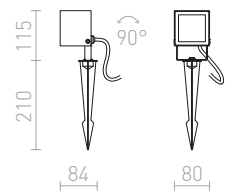

IP65

### COSMO

Foco LED de exterior com estaca no solo. Fornecido com um cabo, sem ficha incluída.

#### COSMO COM ESPIGÃO

230 V LED 10 W  $\angle 24^\circ$  3000 K 850 lm Ra 80 IP65

R12580 cinzento antracite

€ 98

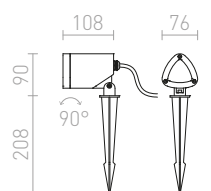



IP65

### HEAVY DUTY

Refletor de alumínio sólido para exterior. A luminária é fornecida com um cabo de 1,5 m, sem ficha incluída. Possibilidade de completar com estaca para o solo (R11755).

#### HEAVY DUTY REFLETOR EXTERIOR

230 V GU10 50 W IP65

R11948 cinzento antracite

€ 68

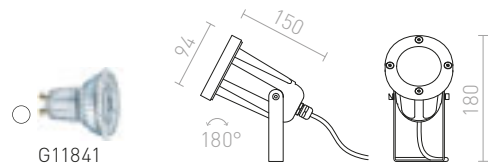

IP65

### FOX

Foco de LED ajustável de uso em exterior com cobertura de vidro transparente para montagem em parede. Para instalação em jardim, é possível montar com estaca no solo (R11755).

#### FOX REFLETOR EXTERIOR

230 V LED 9 W  $\angle 120^\circ$  3000 K 900 lm Ra 80 IP65

R11753 cinzento antracite

€ 178

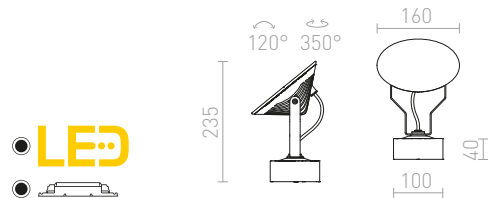

IP65

### ROSS

Foco exterior de LED ajustável com cobertura de vidro acetinado e escolha de ângulo de luz de 8-30 °. Para instalação em jardim, é possível montar com uma estaca no solo (R11755). Fornecido sem cabo de alimentação.

#### ROSS REFLETOR EXTERIOR

230 V LED 9 W  $\angle 30^\circ$  3000 K 900 lm Ra 80 IP65

R11754 cinzento antracite

€ 178

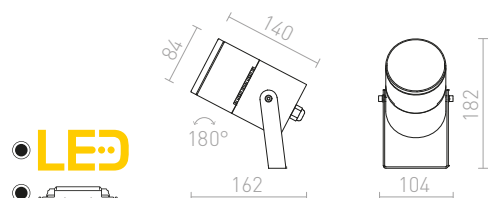



## ESPIGÃO

Espiga universal para luminárias exteriores. O ponto pode ser fixado no casquilho M10 \* 1 ou preso por um parafuso no suporte.

**ESPIGÃO UNIVERSAL PARA SOLO**

R11755 preto

€ 12

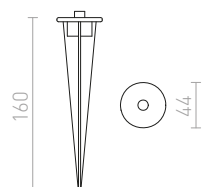



## TOPTOP

Iluminação de solo LED com vigias para montagem em ladrilho sem necessidade de embutir.

### TOPTOP S I

230 V LED 1,5 W 3000 K 105 lm Ra 80 IP67

R13617 cinzento antracite

€ 88

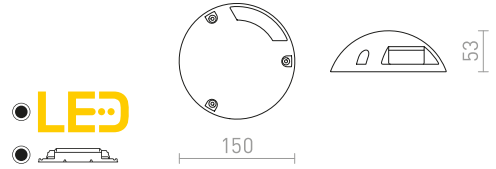

### TOPTOP S III

230 V LED 3x1 W 3000 K 210 lm Ra 80 IP67

R13618 cinzento antracite

€ 88

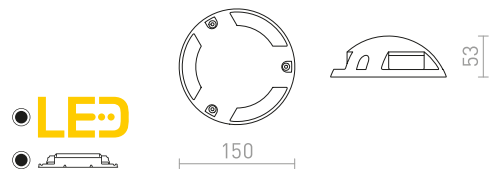



IP54

## FAROS

Luminária de exterior LED de alumínio fundido que ilumina para os lados. Para montagem na parede ou no chão.

### FAROS EXTERIOR

230 V LED 3 W 3000 K 154 lm Ra 80 IP54

R11963 cinzento antracite

€ 120

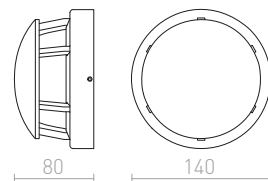

IP67

## TOPTOP

Aplique de exterior com LED e quatro aberturas de visualização sem a necessidade de inserção. Para instalação em jardim, é possível montar com a estaca no solo (R11755).

### TOPTOP IV SOLO

230 V LED 4x1 W 3000 K 400 lm Ra 80 IP67

R11751 cinzento antracite

€ 158

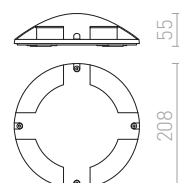

## ESPIGÃO

Espiga universal para luminárias exteriores. O ponto pode ser fixado no casquilho M10 \* 1 ou preso por um parafuso no suporte.

### ESPIGÃO UNIVERSAL PARA SOLO

R11755 preto

€ 12

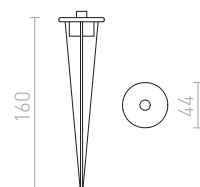





IP65

## BOBO

Lâmpada LED de alumínio saliente para uso exterior, adequada para iluminação de caminhos e escadas, sem necessidade de embutir.

### BOBO R NA PAREDE

230 V LED 3 W 3000 K 212 lm Ra 80 IP65

R13933 cinzento antracite

€ 48

NEW

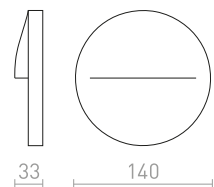
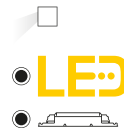



IP65



### BOBO

Lâmpada LED de alumínio saliente para uso exterior; adequada para iluminação de caminhos e escadas, sem necessidade de embutir.

#### BOBO RC NA PAREDE

230V LED 8W 3000K 640lm Ra80 IP65

R13934 cinzento antracite

€ 58

NEW

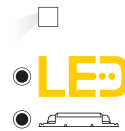
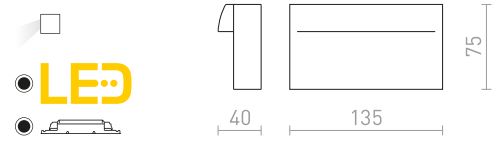

IP65



### BOBO

Lâmpada LED de alumínio saliente para uso exterior; adequada para iluminação de caminhos e escadas, sem necessidade de embutir.

#### BOBO SQ NA PAREDE

230V LED 3W 3000K 135lm Ra80 IP65

R13935 cinzento antracite

€ 48

NEW

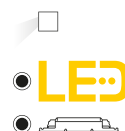
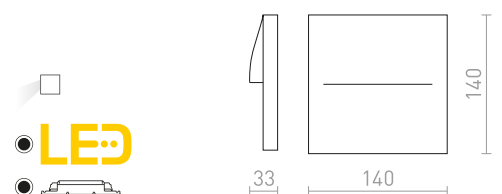



IP65

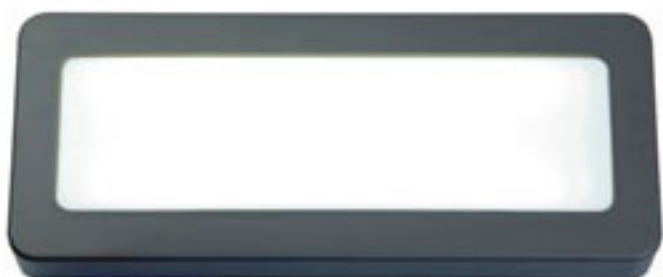

### RENO

Aplique LED de exterior feito de plástico durável com driver.

#### RENO SQ DR DE SUPERFÍCIE

230 V LED 5 W 3000 K 450 lm Ra 80 IP65

R11951 cinzento

€ 48 →

R11954 cinzento antracite

€ 48 →

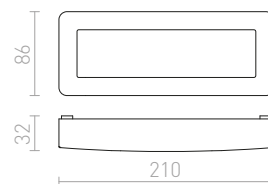

IP65



### RENO

Aplique LED de exterior feito de plástico durável com driver. Disponível em duas cores. Instale apenas para iluminação descendente.

#### RENO R NA PAREDE

230 V LED 2 W 3000 K 180 lm Ra 80 IP65

R11949 cinzento

€ 32 →

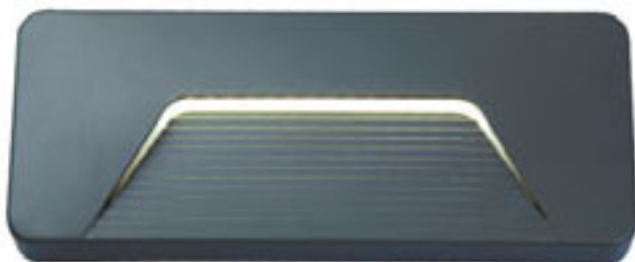
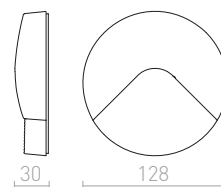
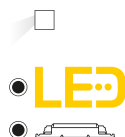

IP65

#### RENO SQ INDR NA PAREDE

230 V LED 3 W 3000 K 280 lm Ra 80 IP65

R11950 cinzento

€ 38 →

R11953 cinzento antracite

€ 38 →

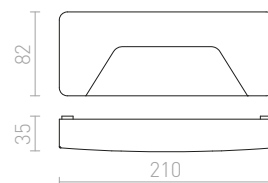
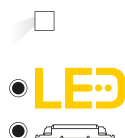





IP54



## ITAKA

Luminária exterior de parede com luz descendente.  
Adequada para iluminação de escadas e estradas.

### ITAKA NA PAREDE

230 V LED 2 W 3000 K 180 lm Ra 80 IP54

R10379 cinzento prata

€ 48 %

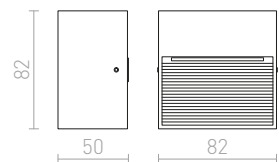
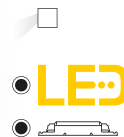



IP54



IP54



IP54

### AQILA

Aplique com LED integrado para iluminação de orientação de pavimentos, escadas ou terraços. Adequado para exterior e interior sem a necessidade de ser embutido.

#### AQILA R NA PAREDE

230 V LED 6 W 3000 K 200 lm Ra 80 IP54

- R12539 branco € 88
- R12540 cinzento € 78
- R12541 cinzento antracite € 88

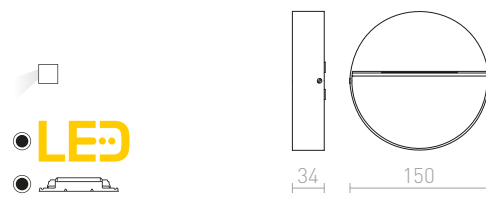

#### AQILA RC NA PAREDE

230 V LED 6 W 3000 K 200 lm Ra 80 IP54

- R12545 branco € 88
- R12547 cinzento antracite € 98

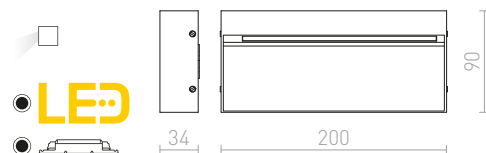

#### AQILA SQ NA PAREDE

230 V LED 6 W 3000 K 200 lm Ra 80 IP54

- R12542 branco € 88
- R12544 cinzento antracite € 88

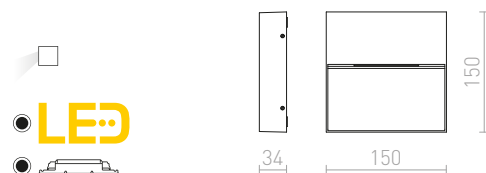





IP54



IP54



IP54

## KICK

Luminária de orientação embutida com LED integrado que emite luz para um, dois ou três lados. Destina-se a instalações de parede.

### KICK I EMBUTIDA

230 V LED 3 W 3000 K 100 lm Ra 80 IP54

R12613 branco

€ 48

R12615 preto

€ 48

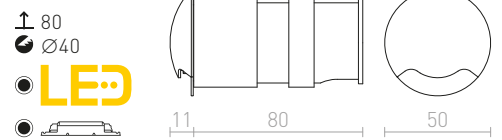

### KICK II EMBUTIDA

230 V LED 3 W 3000 K 120 lm Ra 80 IP54

R12616 branco

€ 48

R12618 preto

€ 48

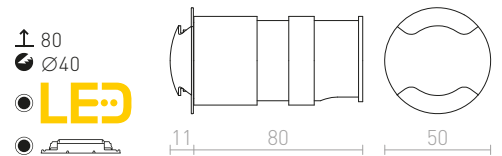

### KICK III EMBUTIDA

230 V LED 3 W 3000 K 150 lm Ra 80 IP54

R12619 branco

€ 48

R12621 preto

€ 48

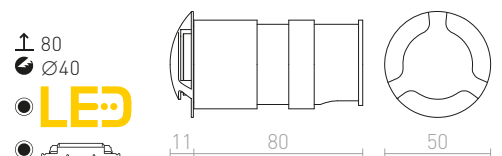





IP54



IP54



IP54

## CLUB

Aplique LED adequado como luz de orientação para corredores e escadas.

### CLUB IND EMBUTIDA

230 V LED 3 W 3000 K 270 lm Ra 80 IP54

R12686 cinzento prata

€ 48

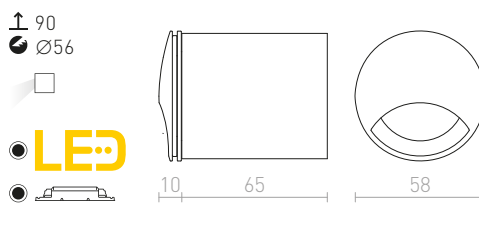

### CLUB EMBUTIDA

230 V LED 3 W 3000 K 270 lm Ra 80 IP54

R12685 cinzento prata

€ 48

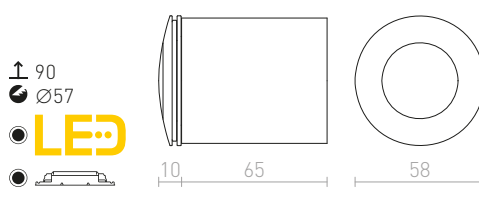

## ELICA

Aplique embutido com LED integrado e uma tampa frontal metálica, para utilização no exterior. Apenas para iluminação descendente. Caixa de montagem incluída.

### ELICA R EMBUTIDA

230 V LED 3 W 3000 K 75 lm Ra 80 IP54

R12528 alumínio escovado

€ 58

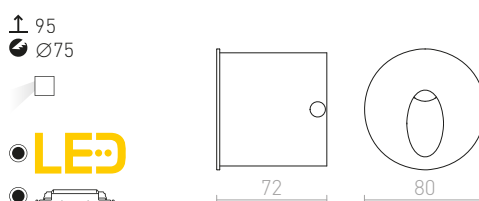



IP54

### MARCO LED

Aplique redondo embutido, adequado para uso interior e exterior. Instale somente para iluminação descendente. Caixa de montagem incluída.

#### MARCO EMBUTIDA

230 V LED 3 W 3000 K 80 lm Ra 80 IP54

R12024 branco

€ 48

R12029 cinzento prata

€ 48

R12030 cinzento antracite

€ 48

↑ 60  
⊗ Ø76



LED

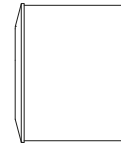

56

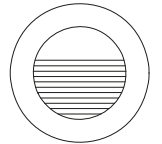

78



IP54



### ASTERIA

Aplique embutido para uso externo. O quadro visível tem uma profundidade de 3 cm. Instale apenas para iluminação descendente.

#### ASTERIA EMBUTIDA

230 V LED 3 W 3000 K 180 lm Ra 80 IP54

R10558 cinzento prata

€ 58

↑ 75  
⊗ Ø113



LED

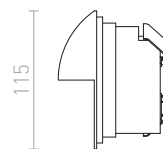

115

32 58

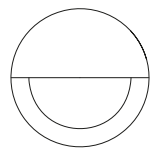

115

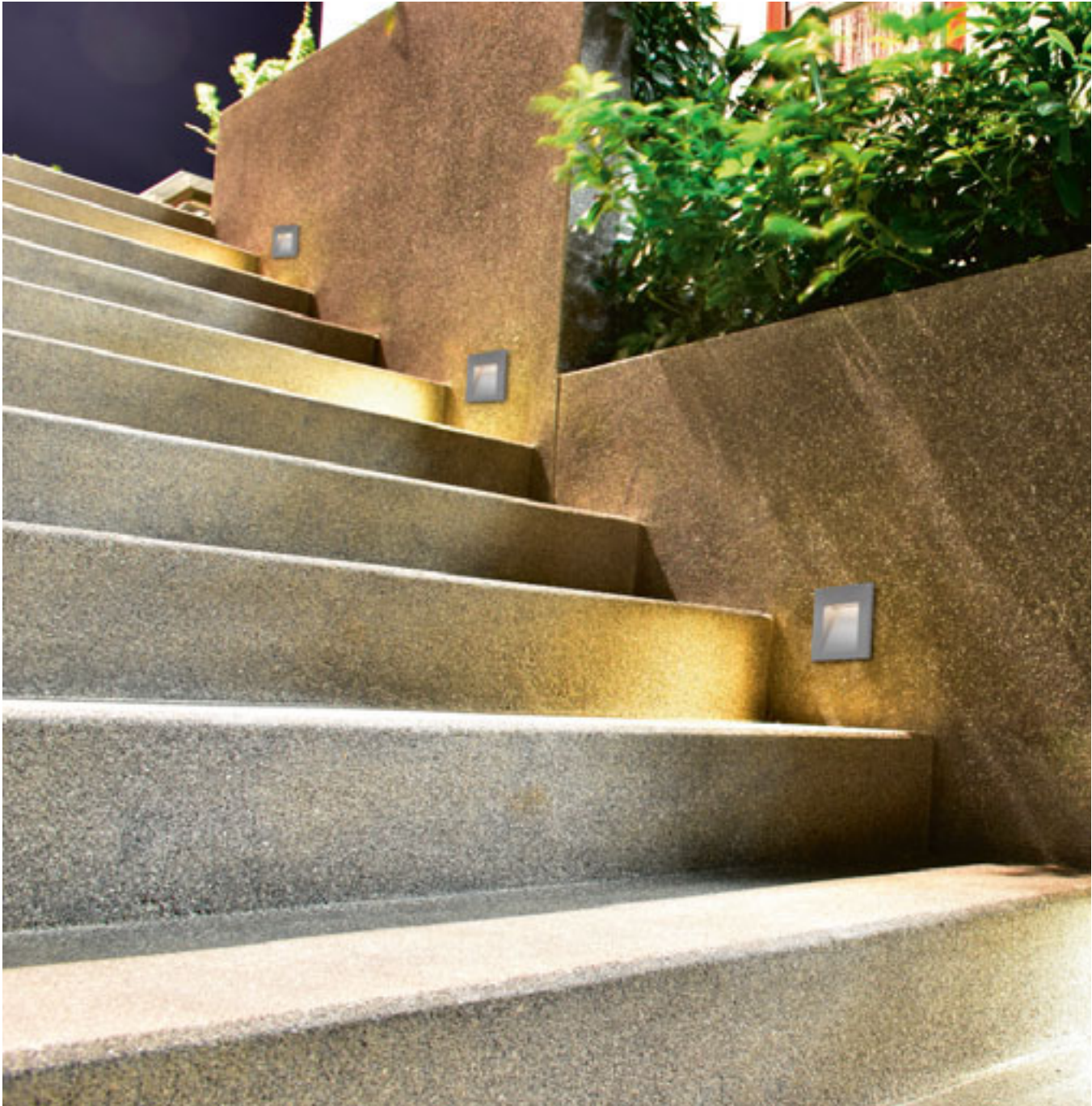

IP54

## TESS

Aplique quadrado embutido adequado para uso interior e exterior. Instale apenas para iluminação descendente. Disponível em três cores diferentes. Caixa de montagem incluída.

### TESS SQ EMBUTIDA

230 V LED 3 W 3000 K 80 lm Ra 80 IP54

<b>R12013</b> branco	€ 58
<b>R12014</b> cinzento prata	€ 58
<b>R12015</b> cinzento antracite	€ 58

↑ 70  
 60x55



● **LED**

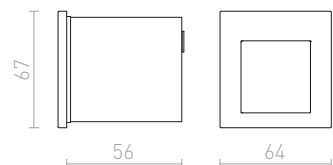



IP65



### RASQ

Luminária embutida LED para uso interior e exterior. Adequada como iluminação de orientação de passeios, escadas ou terraços. Instale apenas para iluminação descendente.

#### RASQ EMBUTIDO NA PAREDE

230 V LED 9 W 3000 K 190 lm Ra 80 IP65

R12627 branco

€ 178

R12628 cinzento antracite

€ 178

↑ 80

▣ 237x77



● LED

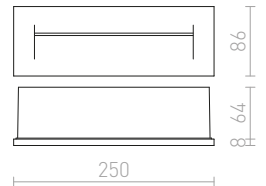

### PER

Aplique LED adequado para uso interior e exterior como luz de orientação para corredores e escadas.

#### PER EMBUTIDA

230 V LED 3 W 3000 K 76 lm Ra 80 IP54

R12576 branco

€ 58

R12577 cinzento antracite

€ 58

↑ 60

▣ 65x102



● LED

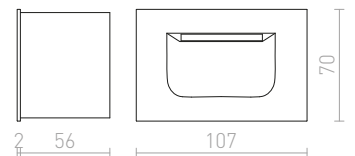

IP54



### ELICA

Aplique embutido com LED integrado e uma tampa frontal metálica, para utilização no exterior. Apenas para iluminação descendente. Caixa de montagem incluída.

#### ELICA SQ EXTERIOR

230 V LED 3 W 3000 K 180 lm Ra 80 IP54

R10639 níquel mate

€ 35

%

R12529 alumínio escovado

€ 58

%

↑ 70

⊘ Ø75



● LED

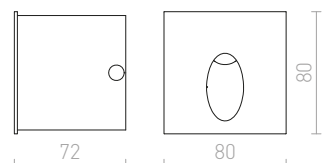

IP54



IP65



IP65



IP65



### GORDIQ

Luminária embutida LED para iluminação direcional de pavimentos, escadas ou terraços. Apenas para iluminação descendente.

#### GORDIQ S EMBUTIDA

230 V LED 1,5 W 3000 K 30 lm Ra 80 IP65

R12533 branco

€ 58

R12534 cinzento antracite

€ 58

↑ 60  
↙ 75x72



LED

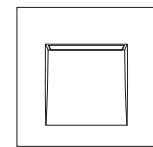
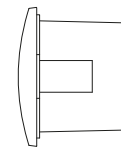

90

#### GORDIQ M EMBUTIDA

230 V LED 3 W 3000 K 90 lm Ra 80 IP65

R12535 branco

€ 88

R12536 cinzento antracite

€ 88

↑ 60  
↙ 115x108



LED

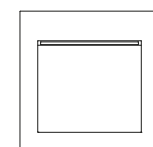
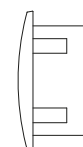

140

#### GORDIQ L EMBUTIDA

230 V LED 3 W 3000 K 90 lm Ra 80 IP65

R12537 branco

€ 68

R12538 cinzento antracite

€ 68

↑ 60  
↙ 115x50



LED

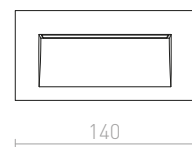
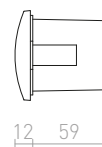

70



IP65

**RAGG**

Iluminação de embutir para exterior com luz direcional para iluminar calçadas e escadas.

**RAGG EMBUTIDA**

230V LED 12W 3000K 406lm Ra80 IP65

**R13620** branco

€ 120

**R13621** preto

€ 120



↑ 80

⚡ 80x230



LED

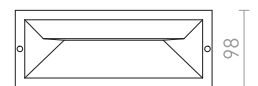

5 85

250

98





IP65



IP65

## DEJAVU

Luminária embutida LED para montagem em parede. Adequada para iluminação direcional de pavimentos, escadas ou terraços.

### DEJAVU SQ 9 EMBUTIDA

230 V LED 3,5 W 3000 K 120 lm Ra 80 IP65

R12530 preto

€ 58 %

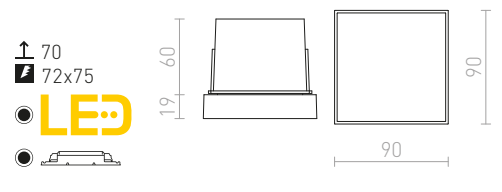

### DEJAVU SQ 14 EMBUTIDA

230 V LED 6 W 3000 K 270 lm Ra 80 IP65

R12531 preto

€ 78 %

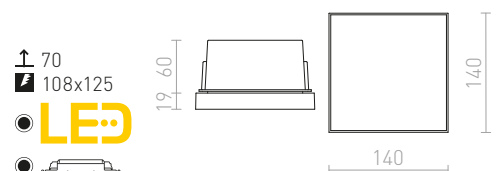





IP54



## SEGNO

Aplique LED embutido para exterior com boa radiação emitida através de fenda estreita.

### SEGNO EMBUTIDA

230 V LED 3 W 3000 K Ra 80 IP54

R13566 branco

€ 98

R13567 cinzento antracite

€ 98

↑ 70

↙ 172x62



LED

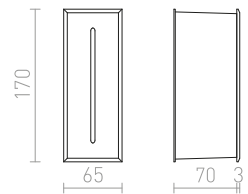

IP54



## FACA

Luminária exterior montada na parede. O quadro visível tem uma profundidade de 2 cm. Iluminação descendente.

### FACA EMBUTIDA

230 V LED 2 W 3000 K 130 lm Ra 80 IP54

R10557 cinzento prata

€ 48 %

↑ 100

↙ 225x85



LED

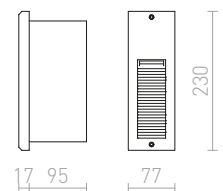



IP54

### GAP

Luminária de parede embutida de alumínio lacado, adequada para uso em exteriores e interiores. Instale apenas para iluminação descendente.

#### GAP EMBUTIDA

230 V LED 3 W 3000 K 180 lm Ra 80 IP54

R10545 cinzento prata

€ 68 %

↑ 55  
 190x45



LED

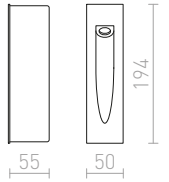

IP65

### AKORD

Luz de parede para uso exterior com moldura de aço inoxidável e vidro transparente. Dimensões do vidro visível são 11,8/11,5 cm.

#### AKORD EMBUTIDO NA PAREDE

230 V LED 3 W 3000 K 260 lm Ra 80 IP65

R10546 aço inoxidável

€ 88 %

↑ 65  
 180x155



LED

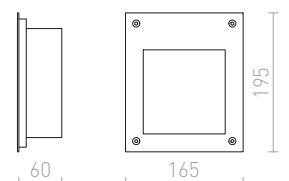



IP67



## ORBU

Luminária de aço inoxidável de metal para exteriores.

### ORBU R

230 V GU10 35 W IP67

R10555 aço inoxidável

€ 78

105

Ø98



G11837

103

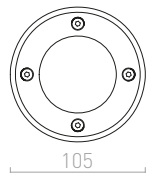

105

### ORBU SQ 10 EMBUTIDA

230 V LED GU10 15 W IP67

R13439 aço inoxidável

€ 78

140

Ø100



G11837

136

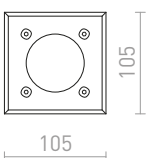

105



IP65



### NAVY

Luminária LED maciça para instalação em tetos exteriores.

#### NAVY EMBUTIDA

230 V LED 15 W  $\angle 36^\circ$  2700 K 1100 lm Ra 80 IP65

R12661 branco

€ 120 %

↑ 110  
⊗ Ø125

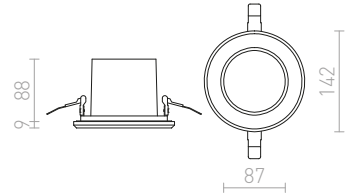
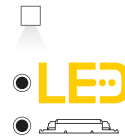

IP65



### TERRA

Luminária de exterior embutida com LED de alta potência. Inclui um cabo de alimentação principal de 1m.

#### TERRA EMBUTIDA

230 V LED 20 W  $\angle 120^\circ$  3000 K 1450 lm Ra 80 IP65

R10532 aço inoxidável

€ 198

↑ 100  
⊗ Ø190

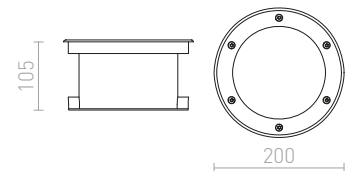
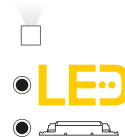

IP65



### RIZZ

Luminária embutida de exterior para instalação no chão com LED integrado e driver.

#### RIZZ SQ 105

230 V LED 3 W  $\angle 96^\circ$  3000 K 128 lm Ra 80 IP65

R10436 aço inoxidável

€ 138

↑ 120  
⊗ Ø90

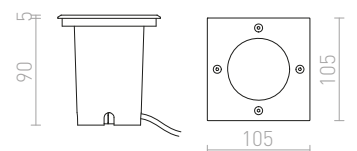
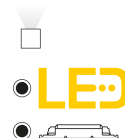





FONTES DE LUZ

# GREEN NEW!

NOVAS CATEGORIAS DE LÂMPADAS LED

**MELHOR EFICIÊNCIA ENERGÉTICA**  
**MAIOR QUALIDADE**

Substitua facilmente as suas lâmpadas clássicas ou de halogéneo atuais por E14, E27, GU10, G9, G53 e outros casquilhos.

MUITO BAIXO CONSUMO DE ENERGIA

VIDA ÚTIL EXTREMAMENTE LONGA

INSTANTANEAMENTE 100% LEVE, SEM ATRASO NO ACIONAMENTO

SEM UV E RADIAÇÃO INFRAVERMELHA MUITO BAIXA NO ESPECTRO VISÍVEL

EMISSÕES DE CALOR MUITO BAIXAS EM COMPARAÇÃO COM PRODUTOS DE REFERÊNCIA PADRÃO

DESIGN, PEQUENAS DIMENSÕES E SAÍDA DE LÚMEN COMPARÁVEIS ÀS LÂMPADAS INCANDESCENTES OU DE HALOGÉNEO



GLOSSÁRIO DE TERMOS

**RETROFIT** substituição direta da lâmpada clássica com encaixe E14 ou E27.

**Não regulável / vida útil até 15,000 h / até 100,000 ciclos de comutação / Ra = 80**

**PRO** lâmpada para uso profissional.

**Regulável / vida útil até 45,000 h / até 1,000,000 de ciclos de comutação / Ra > 90**

**ADV** alta qualidade e flexibilidade para todas as aplicações com escurecimento.

**Regulável / vida útil até 40,000 h / até 100,000 ciclos de comutação / Ra = 80**

**GLOWdim** escurece alterando a intensidade da luz, mas também a cor – de branco quente a branco muito quente (2700K-1800K).

**Regulável / vida útil até 25,000 h / até 100,000 ciclos de comutação / Ra > 80**

**DIMM** – pode ser atenuado com uma variedade de dimmers comercialmente disponíveis.

**Bluetooth** – Controlo por Bluetooth através de App.

**WIFI** – Controlo por WIFI através de App.

**Ra (interpretação de cores)** – mede a taxa de autenticidade de cores gerada por qualquer fonte de luz, em comparação com a luz do dia. Quanto mais perto o número é de 100, menor será a distorção de cor.



80 Ra

90 Ra

**K (Kelvin)** – descreve a temperatura de cor da luz.

1800 K    2700 K    3000 K    4000 K    6500 K    12000 K    16000 K



branco quente 1800–2700 K

branco neutro 3000–3500 K

branco frio 4000–4500 K

luz solar direta 5500–6500 K

**Ângulos de feixe**

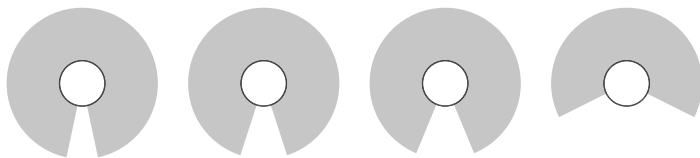

24°

36°

45°

120°



Todos os parâmetros técnicos se aplicam à lâmpada inteira. Devido ao complexo processo de produção de díodos emissores de luz, os valores típicos apresentados para os parâmetros técnicos de LED são valores puramente estatísticos que não necessariamente correspondem aos atuais parâmetros técnicos de cada produto, que podem variar do valor típico.

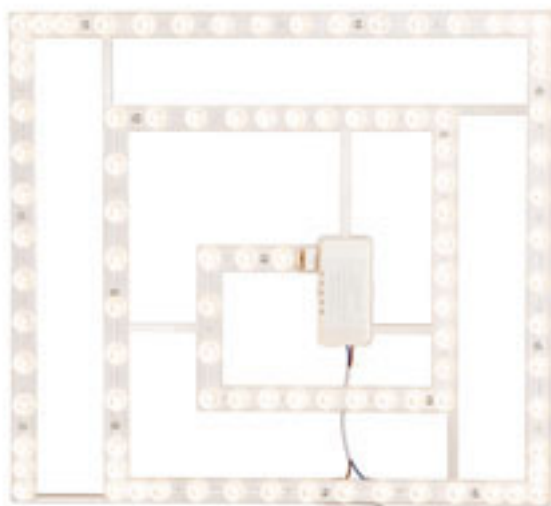

## LED MODUL

Módulo LED sobresselente para uma instalação fácil em luminárias pré-existentes. O módulo é fixado através de pegas magnéticas integradas.

### LED MODUL SQ 10

230 V LED 12 W 3000 K 900 lm Ra 80

G13546

€ 5.50

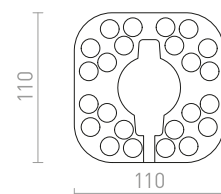
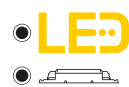

### LED MODUL R 30

230 V LED 36 W 3000 K 2700 lm Ra 80

G13545

€ 14.50

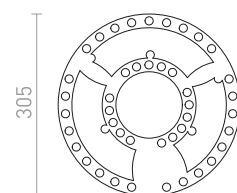

### LED MODUL SQ 41

230 V LED 48 W 3000 K 3600 lm Ra 80

G13547

€ 22

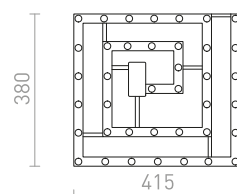





## PARATHOM SMART

Fonte de luz LED inteligente com casquilho E27 controlável usando LEDVANCE SMART + Android 6.0 ou Apple Homekit. Gerenciamento de cores RGBW. Temperatura ajustável da cor da luz: 2700K a 6500K. Pode ser regulado por Bluetooth.

### OSRAM SMART+ RGBW CLASSIC A

230 V E27 LED EQ 60 W 2700 K-6500 K 810 lm Ra 80

G13728 mate

€ 19

Ø60x120 mm

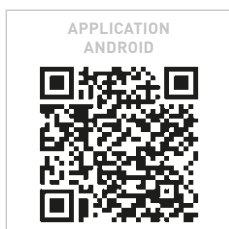

APPLICATION  
ANDROID

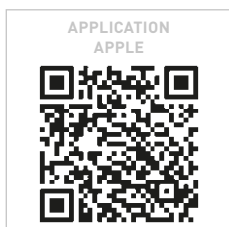

APPLICATION  
APPLE



## PARATHOM SMART

Fonte de luz LED inteligente com casquilho E27 controlável usando LEDVANCE SMART + Android 6.0 ou Apple Homekit. Pode ser regulado por Bluetooth.

### OSRAM SMART+ CLASSIC

230 V E27 LED EQ 60 W 2700 K 800 lm Ra 80

G13700 mate

€ 12

Ø60x120 mm



## PARATHOM RGBW

Fonte de luz LED com tecnologia RGB incorporada, que pode ser definida para várias cores, incluindo branco quente. Não é necessária qualquer instalação ou configuração através de dispositivos móveis. A mudança de cores, modos e regulação da intensidade da luz pode ser efectuada com um simples clique num botão. Inclui um controlo remoto IR.

### OSRAM RGBW CLASSIC A

230 V E27 LED EQ 60 W 2700 K 806 lm Ra 80

G13579 mate

€ 16

Ø60x114 mm





### PARATHOM RGBW

Fonte de luz LED com tecnologia RBG incorporada, que pode ser definida para várias cores, incluindo branco quente. Não é necessária qualquer instalação ou configuração através de dispositivos móveis. A mudança de cores, modos e regulação da intensidade da luz pode ser efetuada com um simples clique num botão. Inclui um controlo remoto IR.

#### OSRAM RGBW PAR16

230 V GU10 LED EQ 25 W 2700 K 250 lm Ra 80

**G13577** branco

€ 15

Ø50x56 mm



### PARATHOM RGBW

Fonte de luz LED com tecnologia RBG incorporada, que pode ser definida para várias cores, incluindo branco quente. Não é necessária qualquer instalação ou configuração através de dispositivos móveis. A mudança de cores, modos e regulação da intensidade da luz pode ser efetuada com um simples clique num botão. Inclui um controlo remoto IR.

#### OSRAM RGBW LÂMPADA

230 V E14 LED EQ 40 W 2700 K 470 lm Ra 80

**G13578** mate

€ 13.50

Ø47x91 mm

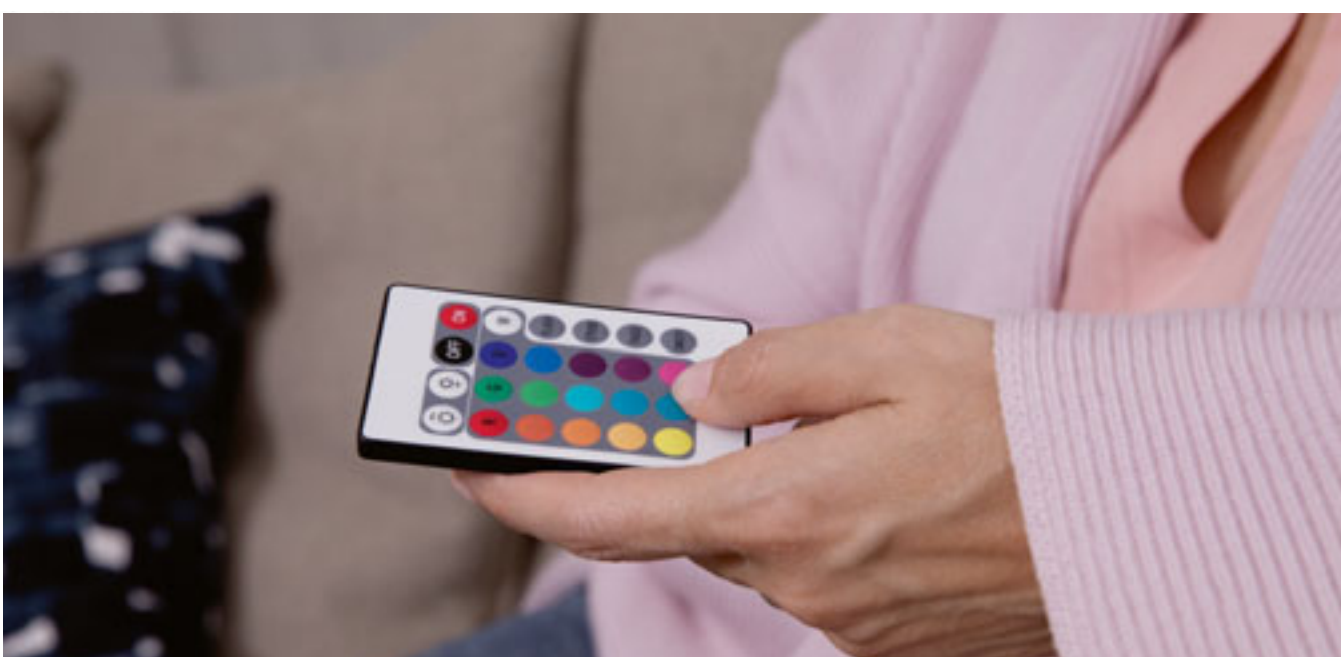



## PARATHOM SMART

Fonte de luz LED Globe Smart WiFi com encaixe E27 regulável usando: LEDVANCE SMART+ WiFi (versão Android 4.4 ou iOS 9.0 ou superior), Google Assistant ou Amazon Alexa. Controlado por Wi-Fi.

### OSRAM SMART+ GLOBE 125 WIFI

230 V E27 LED EQ 60 W 2700 K 806 lm Ra 80

**G13943** claro

€ 22

NEW

Ø124x168 mm



### OSRAM SMART+ GLOBE 125 WIFI

230 V E27 LED EQ 60 W 2700 K 806 lm Ra 80

**G13944** âmbar

€ 25

NEW

Ø124x168 mm



### OSRAM SMART+ GLOBE 125 WIFI

230 V E27 LED EQ 60 W 2700 K 806 lm Ra 80

**G13945** de cor fumo

€ 25

NEW

Ø124x168 mm



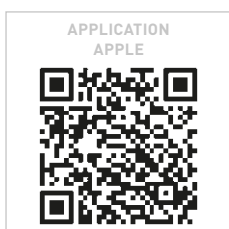
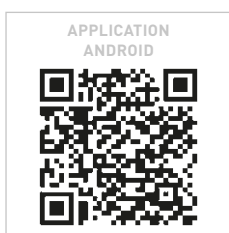

## PARATHOM SMART

LED Lâmpada Globe Smart para casquilhos E27 que podem ser controlados a partir do aplicativo LEDVANCE SMART+ WiFi (é necessário Android 4.4 / iOS 9.0 ou superior), bem como Google Assistant ou Amazon Alexa. A funcionalidade RGBW permite selecionar cores ou definir uma temperatura de cor específica, de 2700K a 6500K. Usa WiFi para comunicar.

### OSRAM SMART+ GLOBE 95

230 V E27 LED EQ 100 W RGBW 1521 lm Ra 80

G13833 mate

€ 38

Ø95x142 mm



**OSRAM  
VINTAGE GLOBE 125 DECO**



Ø125x168 mm  
âmbar  
230 V LED E27 EQ 40 W  
2500 K 470 lm Ra 80  
**G13311**

**€ 25**

**OSRAM  
VINTAGE GLOBE 125 SPIRAL**



Ø125x178 mm  
de cor fumo  
230 V LED E27 EQ 15 W  
1800 K 140 lm Ra 80  
**G13459**

**€ 24**

**OSRAM  
VINTAGE GLOBE 125 SPIRAL**



Ø125x178 mm  
âmbar  
230 V LED E27 EQ 25 W  
2000 K 250 lm Ra 80  
**G13152**

**€ 17**

**OSRAM  
VINTAGE GLOBE 125 DIMM**



Ø125x173 mm  
âmbar regulável  
230 V LED E27 EQ 55 W  
2400 K 650 lm Ra 80  
**G13023**

**€ 18.50**

**OSRAM  
VINTAGE BALLON DIMM**



Ø170x270 mm  
claro regulável  
230 V LED E27 EQ 30 W  
2700 K 400 lm Ra 80  
**G13953** NEW

**€ 88**

**OSRAM  
VINTAGE EDISON ESPIRAL**



Ø64x140 mm  
de cor fumo  
230 V LED E27 EQ 25 W  
1800 K 250 lm Ra 80  
**G13581**

**€ 24**

**OSRAM  
VINTAGE EDISON SPIRAL**



Ø64x140 mm  
âmbar  
230 V LED E27 EQ 25 W  
2000 K 250 lm Ra 80  
**G13309**

**€ 14**

**OSRAM  
RETROFIT EDISON**



Ø64x143 mm  
claro  
230 V LED E27 EQ 40 W  
2700 K 470 lm Ra 80  
**G13573**

**€ 11.50**

**OSRAM  
VINTAGE**



Ø75x156 mm  
âmbar  
230 V LED E27 EQ 40 W  
2500 K 470 lm Ra 80  
**G13310**

**€ 24**

**OSRAM  
RETROFIT TUBE**



Ø25x80 mm  
claro  
230 V LED E14 EQ 40 W  
2700 K 470 lm Ra 80  
**G13150**

**€ 9.20**

**OSRAM  
VINTAGE TUB**



Ø28.5x138 mm  
âmbar  
230 V LED E27 EQ 20 W  
2400 K 200 lm Ra 80  
**G13021**

**€ 13**

**OSRAM  
VINTAGE TUB**



Ø28.5x204 mm  
âmbar  
230 V LED E27 EQ 35 W  
2400 K 400 lm Ra 80  
**G13022**

**€ 17**

**OSRAM  
VINTAGE VELA**



Ø35x100 mm  
âmbar  
230 V LED E14 EQ 35 W  
2400 K 410 lm Ra 80  
**G13308**

**€ 8.35**

**OSRAM  
TOP MINI BOLA**



Ø45x78 mm  
cromo  
230 V LED E14 EQ 31 W  
2700 K  $\angle 320^\circ$  380 lm Ra 80  
**G13013**

**€ 9**

**OSRAM  
TOP CLASSIC A**



Ø60x105 mm  
cromo  
230 V LED E27 EQ 50 W  
2700 K 650 lm Ra 80  
**G13154**

**€ 11**

**OSRAM  
TOP CLASSIC A**



Ø60x105 mm  
folha dourada  
230 V LED E27 EQ 50 W  
2700 K 650 lm Ra 80  
**G13458**

**€ 7.80**

**OSRAM  
RETROFIT GLOBE 125**



Ø124x168 mm  
claro  
230 V LED E27 EQ 25 W  
2700 K 250 lm Ra 80  
**G12244** € 9.80

**OSRAM  
RETROFIT GLOBE 125**



Ø124x168 mm  
claro  
230 V LED E27 EQ 40 W  
2700 K 470 lm Ra 80  
**G12245** € 11.50

**OSRAM  
RETROFIT GLOBE 125**



Ø124x168 mm  
claro  
230 V LED E27 EQ 60 W  
2700 K 806 lm Ra 80  
**G12246** € 14.50

**OSRAM  
RETROFIT GLOBE 125**



Ø124x168 mm  
mate  
230 V LED E27 EQ 100 W  
2700 K 1521 lm Ra 80  
**G13460** € 24

**OSRAM  
RETROFIT GLOBE 95**



Ø95x138 mm  
mate  
230 V LED E27 EQ 60 W  
2700 K 806 lm Ra 80  
**G13024** € 10.50

**OSRAM  
RETROFIT GLOBE 95 DIMM**



Ø95x135 mm  
vidro colorido opala regulável  
230 V LED E27 EQ 75 W  
2700 K 1055 lm Ra 80  
**G13462** € 15.50

**OSRAM  
RETROFIT GLOBE 95 DIMM**



Ø95x135 mm  
vidro colorido opala regulável  
230 V LED E27 EQ 100 W  
2700 K 1521 lm Ra 80  
**G13461** € 22

**OSRAM  
ULTRA ECONOMY  
210LM/W GLOBE 95**



Ø95x140 mm **A**  
claro  
230 V LED E27 EQ 60 W  
3000 K 840 lm Ra 80  
**G13951** **NEW** € 24

**OSRAM  
ULTRA ECONOMY  
210LM/W GLOBE 95**



Ø95x140 mm **A**  
mate  
230 V LED E27 EQ 60 W  
3000 K 840 lm Ra 80  
**G13952** **NEW** € 24

**LAMBRINA  
230**



Ø230x80 mm  
mate  
230 V LED E27 36 W  
3000 K 2200 lm Ra 80  
**G13518** **NEW** € 15.50

**OSRAM  
ULTRA ECONOMY  
210LM/W CLASSIC A**



Ø60x105 mm **A**  
claro  
230 V LED E27 EQ 60 W  
3000 K 840 lm Ra 80  
**G13947** **NEW** € 22

**OSRAM  
ULTRA ECONOMY  
210LM/W CLASSIC A**



Ø60x105 mm **A**  
claro  
230 V LED E27 EQ 100 W  
3000 K 1521 lm Ra 80  
**G13948** **NEW** € 28

**OSRAM  
ULTRA ECONOMY  
210LM/W CLASSIC A**



Ø60x105 mm **A**  
mate  
230 V LED E27 EQ 60 W  
3000 K 840 lm Ra 80  
**G13949** **NEW** € 22

**OSRAM  
ULTRA ECONOMY  
210LM/W CLASSIC A**



Ø60x105 mm **A**  
mate  
230 V LED E27 EQ 100 W  
3000 K 1521 lm Ra 80  
**G13950** **NEW** € 28

**OSRAM  
RETROFIT VELA**



Ø35x100 mm  
claro  
230 V LED E14 EQ 40 W  
2700 K 470 lm Ra 80  
**G11849**

**€ 5.35**

**OSRAM  
RETROFIT VELA**



Ø35x100 mm  
claro  
230 V LED E14 EQ 40 W  
4000 K 470 lm Ra 80  
**G13455**

**€ 5.35**

**OSRAM  
RETROFIT VELA**



Ø35x100 mm  
claro  
230 V LED E14 EQ 60 W  
2700 K 806 lm Ra 80  
**G13725**

**€ 8.25**

**OSRAM  
RETROFIT VELA**



Ø35x100 mm  
mate  
230 V LED E14 EQ 25 W  
2700 K 250 lm Ra 80  
**G13946** NEW

**€ 4.80**

**OSRAM  
RETROFIT VELA DIMM**



Ø35x97 mm  
mate regulável  
230 V LED E14 EQ 40 W  
2700 K 470 lm Ra 80  
**G13151**

**€ 7.80**

**OSRAM  
RETROFIT VELA DIMM**



Ø35x100 mm  
mate regulável  
230 V LED E14 EQ 60 W  
2700 K 806 lm Ra 80  
**G13454**

**€ 11.50**

**OSRAM  
RETROFIT MINI BOLA DIMM**



Ø45x78 mm  
mate regulável  
230 V LED E14 EQ 25 W  
2700 K 250 lm Ra 80  
**G13847** NEW

**€ 7.80**

**OSRAM  
RETROFIT MINI BOLBO DE  
LUZ**



Ø45x78 mm  
claro  
230 V LED E14 EQ 40 W  
2700 K 470 lm Ra 80  
**G12243**

**€ 5.80**

**OSRAM  
RETROFIT MINI BOLA DIMM**



Ø45x78 mm  
claro regulável  
230 V LED E14 EQ 60 W  
2700 K 806 lm Ra 80  
**G13572**

**€ 8.80**

**OSRAM  
RETROFIT MINI BOLA**



Ø45x77 mm  
mate  
230 V LED E14 EQ 40 W  
2700 K 470 lm Ra 80  
**G13098**

**€ 5.50**

**OSRAM  
RETROFIT MINI BOLA DIMM**



Ø45x78 mm  
mate regulável  
230 V LED E14 EQ 60 W  
2700 K 806 lm Ra 80  
**G13453**

**€ 11.50**

**OSRAM  
RETROFIT MINI BOLBO DE  
LUZ DIMM**



Ø45x77 mm  
claro regulável  
230 V LED E27 EQ 40 W  
2700 K 470 lm Ra 80  
**G13014**

**€ 8.25**

**OSRAM  
RETROFIT MINI BOLA**



Ø45x77 mm  
claro  
230 V LED E27 EQ 60 W  
2700 K 806 lm Ra 80  
**G13307**

**€ 8.80**

**OSRAM  
RETROFIT MINI BOLA DIMM**



Ø45x77 mm  
mate regulável  
230 V LED E27 EQ 25 W  
2700 K 250 lm Ra 80  
**G13119**

**€ 7.80**

**OSRAM  
RETROFIT MINI BOLA DIMM**



Ø45x77 mm  
mate regulável  
230 V LED E27 EQ 40 W  
2700 K 470 lm Ra 80  
**G13015**

**€ 8.50**

**OSRAM  
RETROFIT CLASSIC A DIMM**



Ø60x105 mm  
claro regulável  
230 V LED E27 EQ 40 W  
2700 K 470 lm Ra 80  
**G13110** € 7.35

**OSRAM  
RETROFIT CLASSIC A DIMM**



Ø60x105 mm  
claro regulável  
230 V LED E27 EQ 60 W  
2700 K 806 lm Ra 80  
**G13111** € 7.35

**OSRAM  
RETROFIT CLASSIC A DIMM**



Ø60x105 mm  
claro regulável  
230 V LED E27 EQ 75 W  
2700 K 1055 lm Ra 80  
**G13112** € 11

**OSRAM  
RETROFIT CLASSIC A DIMM**



Ø60x105 mm  
claro regulável  
230 V LED E27 EQ 100 W  
2700 K 1521 lm Ra 80  
**G13123** € 14.50

**OSRAM  
RETROFIT CLASSIC A DIMM**



Ø60x105 mm  
mate regulável  
230 V LED E27 EQ 40 W  
2700 K 470 lm Ra 80  
**G13099** € 8.35

**OSRAM  
RETROFIT CLASSIC A DIMM**



Ø60x106 mm  
mate regulável  
230 V LED E27 EQ 60 W  
2700 K 806 lm Ra 80  
**G13026** € 8.35

**OSRAM  
RETROFIT CLASSIC A DIMM**



Ø60x105 mm  
mate regulável  
230 V LED E27 EQ 60 W  
4000 K 806 lm Ra 80  
**G13027** € 8.35

**OSRAM  
RETROFIT CLASSIC A DIMM**



Ø60x105 mm  
mate regulável  
230 V LED E27 EQ 75 W  
2700 K 1055 lm Ra 80  
**G13028** € 12

**OSRAM  
RETROFIT CLASSIC A DIMM**



Ø60x105 mm  
mate regulável  
230 V LED E27 EQ 75 W  
4000 K 1055 lm Ra 80  
**G13477** € 12

**OSRAM  
RETROFIT CLASSIC A**



Ø60x105 mm  
mate  
230 V LED E27 EQ 100 W  
2700 K 1521 lm Ra 80  
**G13029** € 12

**OSRAM  
RETROFIT CLASSIC A DIMM**



Ø60x105 mm  
mate regulável  
230 V LED E27 EQ 100 W  
2700 K 1521 lm Ra 80  
**G13306** € 14.50

**OSRAM  
RETROFIT CLASSIC A**



Ø70x118 mm  
mate  
230 V LED E27 EQ 150 W  
2700 K 2452 lm Ra 80  
**G13457** € 24

**OSRAM  
ADV CLASSIC A DIMM**



Ø67x143 mm  
mate regulável  
230 V LED E27 EQ 150 W  
2700 K <200° 2452 lm Ra 80  
**G12237** € 24

**OSRAM  
RETROFIT CLASSIC A**



Ø95x162 mm  
mate  
230 V LED E27 EQ 200 W  
2700 K 3452 lm Ra 80  
**G13831** € 35

**OSRAM  
RETROFIT CLASSIC A DIMM**



Ø90x184 mm  
mate regulável  
230 V LED E27 EQ 200 W  
2700 K 3452 lm Ra 80  
**G13832** € 35



**LED E27  
TUBE**



Ø50x100 mm  
230 V LED E27 7,5 W  
3000 K ∠180° 700 lm Ra 80  
**G12985** ➔ **€ 3.80**

**OSRAM  
TUBE**



Ø36x116 mm  
mate  
230 V LED E27 EQ 75 W  
2700 K 1050 lm Ra 80  
**G13155** **€ 7.80**

**OSRAM  
PIN MICRO G4**



Ø10x30 mm  
12 V LED G4 EQ 10 W  
2700 K ∠300° 100 lm Ra 80  
**G13828** **€ 11**

**OSRAM  
PIN G4**



Ø13x36 mm  
12 V LED G4 EQ 20 W  
2700 K ∠300° 200 lm Ra 80  
**G13034** **€ 7.35**

**OSRAM  
PIN G4**



Ø14x40 mm  
12 V LED G4 EQ 30 W  
2700 K ∠320° 300 lm Ra 80  
**G13035** **€ 8.80**

**OSRAM  
PIN G9**



Ø16x60 mm  
vidro transparente  
230 V LED G9 EQ 30 W  
2700 K ∠320° 300 lm Ra 80  
**G13478** ➔ **€ 11**

**OSRAM  
PIN G9**



Ø15x46 mm  
230 V LED G9 EQ 20 W  
2700 K 200 lm Ra 80  
**G13715** **€ 6.80**

**OSRAM  
PIN G9**



Ø15x47 mm  
230 V LED G9 EQ 30 W  
2700 K ∠300° 320 lm Ra 80  
**G13036** **€ 8.80**

**OSRAM  
PIN G9 DIMM**



Ø16x52 mm  
regulável  
230 V LED G9 EQ 30 W  
2700 K 320 lm Ra 80  
**G13829** **€ 17**

**OSRAM  
PIN G9**



Ø19x52 mm  
230 V LED G9 EQ 40 W  
2700 K ∠300° 470 lm Ra 80  
**G13037** **€ 12**

**OSRAM  
PIN G9**



Ø19x52 mm  
230 V LED G9 EQ 40 W  
4000 K ∠300° 470 lm Ra 80  
**G13038** **€ 12**

**OSRAM  
PIN G9 DIMM**



Ø18x59 mm  
regulável  
230 V LED G9 EQ 40 W  
2700 K 470 lm Ra 80  
**G13830** **€ 22**

**OSRAM  
PIN G9**



Ø18x59 mm  
230 V LED G9 EQ 50 W  
2700 K ∠320° 600 lm Ra 80  
**G13464** **€ 17**

**OSRAM  
SPECIAL SLIM**



Ø18x90 mm  
claro  
230 V LED B15d EQ 60 W  
2700 K ∠320° 806 lm Ra 80

**G13456 € 38**

**OSRAM  
SPECIAL SLIM DIMM**



Ø18x100 mm  
claro regulável  
230 V LED B15D EQ 75 W  
2700 K 1055 lm Ra 80

**G13574 € 48**

**OSRAM  
SLIM LINE 118MM**



Ø20x118 mm  
claro  
230 V LED R7S EQ 100 W  
2700 K 1521 lm Ra 80

**G13576 € 24**

**OSRAM  
LINE 118MM DIMM**



Ø28x118 mm  
regulável  
230 V LED R7S EQ 125 W  
2700 K ∠300° 2000 lm Ra 80

**G13044 € 38**

**OSRAM  
LINE 118MM DIMM**



Ø28x118 mm  
claro regulável  
230 V LED R7s EQ 150 W  
2700 K 2452 lm Ra 80

**G13468 € 58**

**OSRAM  
SLIM LINE 78MM**



Ø20x78 mm  
claro  
230 V LED R7S EQ 60 W  
2700 K ∠300° 806 lm Ra 80

**G13575 € 16.50**

**OSRAM  
LINE 78MM DIMM**

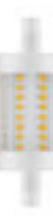

Ø29x78 mm  
regulável  
230 V LED R7S EQ 75 W  
2700 K ∠300° 1055 lm Ra 80

**G13043 € 18**

**OSRAM  
LINE 78MM DIMM**



Ø28x78 mm  
claro regulável  
230 V LED R7s EQ 100 W  
2700 K 1521 lm Ra 80

**G13467 € 32**

**OSRAM  
HALO PIN G9**



Ø14x43 mm  
claro regulável  
230 V G9 EQ 25 W  
2700 K 235 lm Ra 100

**G13122 € 5**

**OSRAM  
HALO PIN G9**



Ø14x43 mm  
claro regulável  
230 V G9 EQ 40 W  
2700 K 460 lm Ra 100

**G13045 € 5**

**OSRAM  
HALO LINE 78MM**



Ø12x78 mm  
claro regulável  
230 V R7S EQ 60 W  
2900 K 750 lm Ra 100

**G13047 € 9**

**OSRAM  
MR16 DIMM**



Ø50x44 mm  
regulável  
12 V LED GU5,3 EQ 35 W  
3000 K ∠36° 345 lm Ra 90

**G13960** NEW € 12

**OSRAM  
PRO MR16 DIMM**



Ø51x46 mm  
regulável  
12 V LED GU5,3 EQ 20 W  
3000 K ∠36° 230 lm Ra 97

**G12234** € 11

**OSRAM  
MR16 DIMM**



Ø50x44 mm  
regulável  
12 V LED GU5,3 EQ 50 W  
3000 K ∠36° 621 lm Ra 90

**G13705** € 17.50

**OSRAM  
PAR16 DIMM**



Ø51x55 mm  
regulável  
230 V LED GU10 EQ 35 W  
2700 K ∠36° 230 lm Ra 90

**G13120** € 7.80

**OSRAM  
ADV PAR16 DIMM**



Ø51x55 mm  
regulável  
230 V LED GU10 EQ 35 W  
3000 K ∠36° 230 lm Ra 90

**G11837** € 7.80

**OSRAM  
ADV PAR16 DIMM**



Ø50x52 mm  
regulável  
230 V LED GU10 EQ 35 W  
4000 K ∠36° 230 lm Ra 90

**G12206** € 7.80

**OSRAM  
PRO PAR16 DIMM**



Ø51x55 mm  
regulável  
230 V LED GU10 EQ 35 W  
3000 K ∠36° 230 lm Ra 97

**G11852** € 10.50

**OSRAM  
ADV PAR16 DIMM**



Ø50x52 mm  
regulável  
230 V LED GU10 EQ 50 W  
2700 K ∠36° 350 lm Ra 90

**G11840** € 8.35

**OSRAM  
ADV PAR16 DIMM**



Ø51x55 mm  
regulável  
230 V LED GU10 EQ 50 W  
3000 K ∠36° 350 lm Ra 90

**G11841** € 8.35

**OSRAM  
ADV PAR16 DIMM**



Ø50x52 mm  
regulável  
230 V LED GU10 EQ 50 W  
4000 K ∠36° 350 lm Ra 90

**G12207** € 8.35

**OSRAM  
PAR16**



Ø51x55 mm  
regulável  
230 V LED GU10 EQ 50 W  
2700 K ∠120° 350 lm Ra 80

**G12232** € 6

**OSRAM  
ADV PAR16 DIMM**



Ø50x52 mm  
regulável  
230 V LED GU10 EQ 80 W  
3000 K ∠36° 550 lm Ra 90

**G12065** € 13

**OSRAM  
PAR16 DIMM**



Ø51x54 mm  
regulável  
230 V LED GU10 EQ 80 W  
4000 K ∠36° 575 lm Ra 90

**G13041** € 13

**OSRAM  
PAR16 DIMM**



Ø50x52 mm  
regulável  
230 V LED GU10 EQ 80 W  
2700 K ∠120° 575 lm Ra 90

**G13040** € 13

**OSRAM  
PAR16 DIMM**



Ø50x52 mm  
regulável  
230 V LED GU10 EQ 100 W  
3000 K ∠36° 750 lm Ra 80

**G13706** € 19

**OSRAM  
PAR16**



Ø50x53 mm  
branco  
230 V LED GU10 EQ 35 W  
2700 K ∠36° 230 lm Ra 80  
**G13465 € 4.35**

**OSRAM  
PAR16**



Ø50x53 mm  
branco  
230 V LED GU10 EQ 50 W  
2700 K ∠36° 350 lm Ra 80  
**G13466 € 6**

**ALFA  
69**



Ø69x70 mm  
cinzento prata/cromo  
230 V LED GU10 6 W  
3000 K ∠24° 300 lm Ra 80  
**G13406 € 11**

**ALFA  
69**



Ø69x70 mm  
cinzento prata/cromo  
230 V LED GU10 6 W  
4000 K ∠24° 300 lm Ra 80  
**G13407 € 11**

**OSRAM  
PRO AR111 DIMM**



Ø111x62 mm  
regulável  
12 V LED G53 EQ 50 W  
3000 K ∠24° 450 lm Ra 90  
**G13722 € 48**

**OSRAM  
PRO AR111 DIMM**



Ø111x62 mm  
regulável  
12 V LED G53 EQ 100 W  
2700 K ∠24° 950 lm Ra 90  
**G13723 € 58**

**OSRAM  
PRO AR111 DIMM**



Ø107x55 mm  
regulável  
12 V LED G53 EQ 75 W  
4000 K ∠24° 800 lm Ra 97  
**G13724 € 48**

**OSRAM  
PRO AR111 DIMM**



Ø111x62 mm  
regulável  
12 V LED G53 EQ 50 W  
3000 K ∠40° 450 lm Ra 97  
**G13655 € 48**

**OSRAM  
PRO AR111 DIMM**



Ø111x62 mm  
regulável  
12 V LED G53 EQ 75 W  
3000 K ∠40° 800 lm Ra 97  
**G13656 € 48**

**OSRAM  
PRO AR111 DIMM**



Ø111x62 mm  
regulável  
12 V LED G53 EQ 75 W  
3000 K ∠24° 800 lm Ra 97  
**G13657 € 48**

**LED  
ES111**



Ø111x70 mm  
branco  
230 V LED GU10 12 W  
3000 K ∠45° 1000 lm Ra 80  
**G12723 € 12**

**LED  
ES111**



Ø111x70 mm  
cinzento  
230 V LED GU10 12 W  
3000 K ∠45° 1000 lm Ra 80  
**G12724 € 12**

**LED  
ES111**



Ø111x70 mm  
branco  
230 V LED GU10 12 W  
4000 K ∠45° 1000 lm Ra 80  
**G12725 € 12**

**LED  
ES111**



Ø111x70 mm  
cinzento  
230 V LED GU10 12 W  
4000 K ∠45° 1000 lm Ra 80  
**G12726 € 12**

**OSRAM  
R50 DIMM**



Ø50x85 mm  
regulável  
230 V LED E14 EQ 60 W  
2700 K ∠36° 345 lm Ra 90

**G13147 € 11.50**

**OSRAM  
R63 DIMM**



Ø63x105 mm  
regulável  
230 V LED E27 EQ 60 W  
2700 K ∠36° 345 lm Ra 90

**G13148 € 14**

**OSRAM  
R80 DIMM**



Ø80x115 mm  
regulável  
230 V LED E27 EQ 100 W  
2700 K ∠36° 670 lm Ra 80

**G13149 € 18**

**OSRAM  
PAR20 DIMM**



Ø65x85 mm  
regulável  
230 V LED E27 EQ 50 W  
2700 K ∠36° 345 lm Ra 90

**G13020 € 12**

**OSRAM  
ADV PAR30 DIMM**



Ø95x93 mm  
regulável  
230 V LED E27 EQ 75 W  
2700 K ∠36° 633 lm Ra 90

**G12067 € 22**

**OSRAM  
ADV PAR38 DIMM**



Ø120x132 mm  
regulável  
230 V LED E27 EQ 120 W  
2700 K ∠30° 1035 lm Ra 80

**G12068 € 32**



**OSRAM  
PAR16 GLOWDIM**



Ø50x54 mm  
regulável  
230 LED GU10 EQ 50 W  
2700 K ∠36° 350 lm Ra 80

**G13185 € 11.50**

**OSRAM  
ADV VELA GLOWDIM**



Ø38x105 mm  
mate regulável  
230 V LED E14 EQ 40 W  
2700 K 470 lm Ra 80

**G12209 % € 8.50**

**OSRAM LEDINESTRA  
1P 30 DIMM**

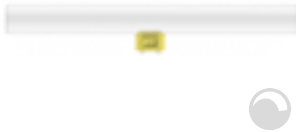

Ø300 mm  
mate regulável  
230 V LED S14d EQ 27 W  
2700 K 275 lm Ra 80  
**G11860** € 38

**OSRAM LEDINESTRA  
1P 50 DIMM**



Ø500 mm  
mate regulável  
230 V LED S14d EQ 40 W  
2700 K 470 lm Ra 80  
**G11862** € 48

**OSRAM LEDINESTRA  
2P 30 DIMM**

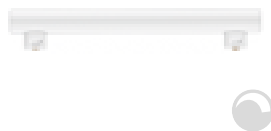

Ø300 mm  
mate regulável  
230 V LED S14s EQ 27 W  
2700 K 275 lm Ra 80  
**G11859** € 38

**OSRAM LEDINESTRA  
2P 50 DIMM**



Ø500 mm  
mate regulável  
230 V LED S14s EQ 40 W  
2700 K 470 lm Ra 80  
**G11861** € 48

**OSRAM LEDINESTRA  
2P 100 DIMM**



Ø29x1000 mm  
mate regulável  
230 V LED S14s EQ 75 W  
2700 K 1055 lm Ra 80  
**G12251** € 88

**OSRAM  
DULUX L**

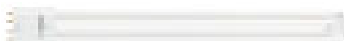

Ø413 mm  
mate  
230 V LED 2G11 EQ 36 W  
3000 K 2070 lm Ra 80  
**G13469** € 48

**OSRAM  
DULUX L**



Ø413 mm  
mate  
230 V LED 2G11 EQ 36 W  
4000 K 2300 lm Ra 80  
**G13470** € 48

**OSRAM  
STAR**



Ø75x28 mm  
230 V LED GX53 EQ 40 W  
2700 K ∠120° 470 lm Ra 80  
**G13032** € 11.50

**OSRAM  
STAR**



Ø75x28 mm  
230 V LED GX53 EQ 40 W  
4000 K ∠120° 470 lm Ra 80  
**G13033** € 11.50

**PUC  
FONTE DE LUZ**



Ø74x27 mm  
230 V LED GX53 7 W  
3000 K ∠105° 560 lm Ra 80  
**G12340** € 8



ACESSÓRIOS PARA CANDEEIROS





### DRIVER

LED driver 350mA.

#### DRIVER LED 1-3W

350 mA 4,2W

G13124

€ 5.80

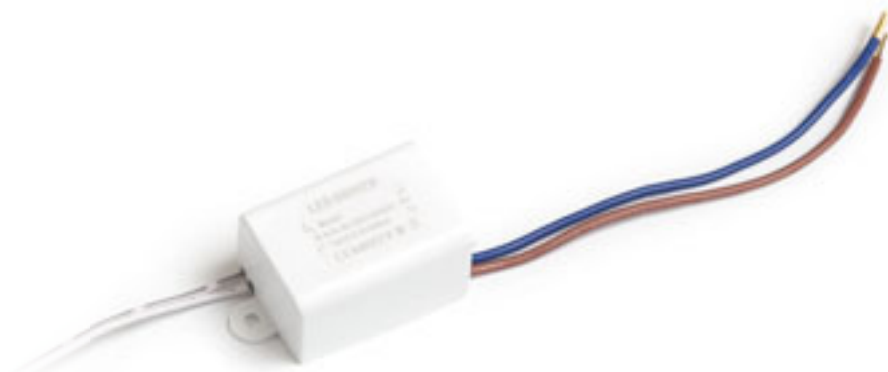
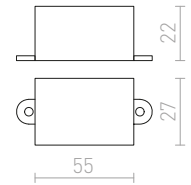

### DRIVER

Driver LED 700mA.

#### DRIVER LED 1x3W

700 mA 3 W

G13125

€ 5.80

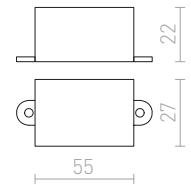

### DRIVER

LED driver 350mA.

#### DRIVER LED 3-8W

350 mA 8,5 W

G13008

€ 28

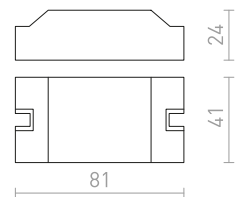

### DRIVER

LED driver 350mA.

#### DRIVER LED 7-15W

350 mA 16 W

G13806

€ 8.50

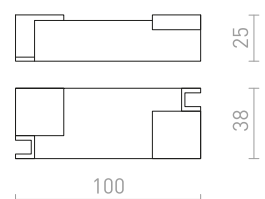



### TRAFÓ 12V

Transformador 12 AC.

#### TRAFÓ 20-70W 12V AC DIMM

12 V 70 W

G13002

€ 19

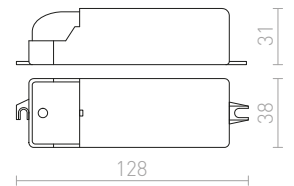

### TRAFÓ 12V

Transformador 12 AC.

#### TRAFÓ 35-105W 12V AC DIMM

12 V 105 W

G13003

€ 22

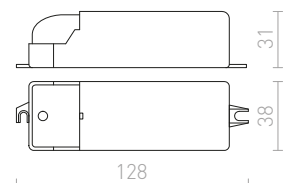

### TRAFÓ 12V

Transformador 12 AC.

#### TRAFÓ 50-150W 12V AC DIMM

12 V 150 W

G13004

€ 58

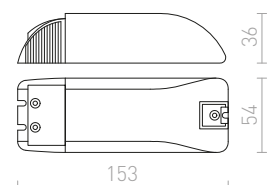



## DRIVER

Controlador LED 500mA 9-18W. TRIAC regulável.

### DRIVER LED 9-18W DIMM

500 mA max 18 W

G13840

€ 48

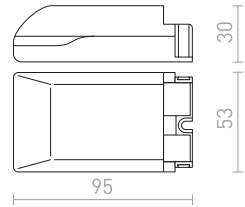

regulável



## DRIVER

Driver LED 700mA 3x3W. Regulador TRIAC.

### DRIVER LED 3x3W DIMM

700 mA 10 W

G13009

€ 35

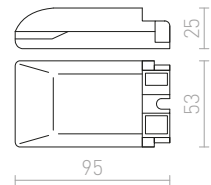

regulável



## TRAF0 12V=

Transformador 12V DC.

### TRAF0 0-20W

230 V/12 V= 20 W IP67

G14018

€ 22

NEW

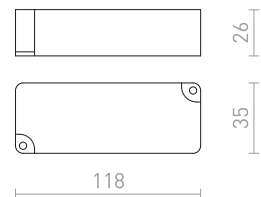

## TRAF0 24V=

Transformador 24V DC.

### TRAF0 0,5-20W

24= 20 W

G13006

€ 48

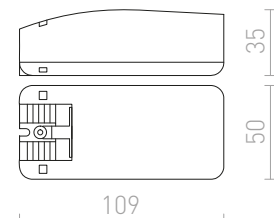



IP44

**IP-BOX**

Bloco de terminais com proteção contra ambientes húmidos. Adequado para cabo 3x1,5.

**IP-BOX**  
IP44

G12582 branco

€ 1.80

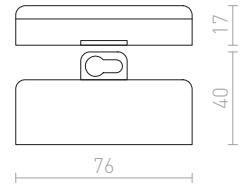

IP67

**IP-BOX**

Junta de ligação adequada para ambientes externos. Adequado para cabo 3x1,5.

**IP-BOX**  
230 V IP67

G12984

€ 5.20

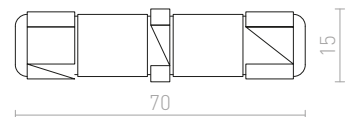

IP65

**IP-BOX**

Caixas de ligação adequadas para ambientes externos. Adequado para cabo 3x1,5.

**IP-BOX**  
230 V IP65

G12983

€ 3.80

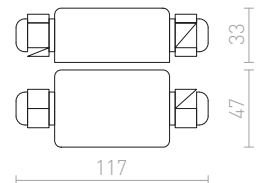

IP68

**IP-BOX**

Junta de cabo para uso externo. Adequado para cabos 2x1,5. Fornecido com 4 arruelas e 2 fichas.

**IP-BOX IP68**  
IP68

G13846 preto

€ 12

NEW

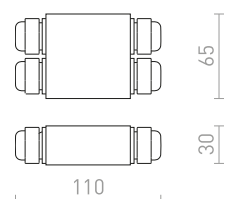



## SENSOR

Adaptador no casquilho E27 com sensor de movimento integrado.

### SENSOR E27

230 V E27 60 W ∠360°

G12752

€ 11

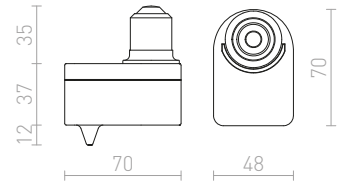

## SENSOR

Sensor de movimento para montagem no teto ou na parede.

### SENSOR TETO

230 V max 2000 W ∠360°

G12754

€ 12.50

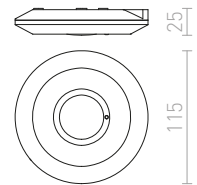

## SENSOR

Sensor de movimento para montagem em luminárias adequadas.

### SENSOR PARA ENCAIXE NUMA LUMINÁRIA

230 V max 1200 W ∠360°

G12755 branco

€ 10.50

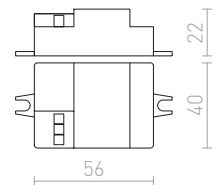

IP65



## IP-BOX

Cobertura durável em ambiente húmido para proteger o sensor de movimento G12755.

### IP-BOX PARA SENSOR G12755

IP65

G12756

€ 4.80

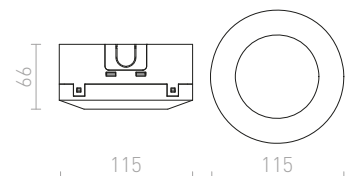



### SENSOR

Sensor de movimento com sensor externo no cabo. O sensor externo é usado apenas para detectar (determinar) a intensidade da luz para o correto funcionamento do sensor.

#### SENSOR ACIMA DO TETO

max 1200 W  $\angle 360^\circ$

G12753 branco

€ 13.50

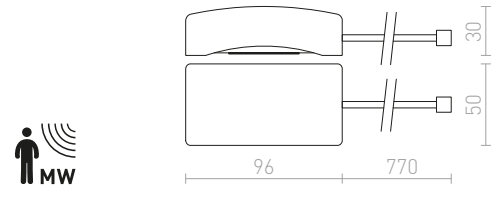

IP65

### SENSOR

Sensor de movimento para montagem em luminárias.

#### SENSOR PARA MONTAGEM EM LÂMPADAS EXTERIORES

230 V max 500 W  $\angle 180^\circ$  IP65

G12757 branco

€ 6 %

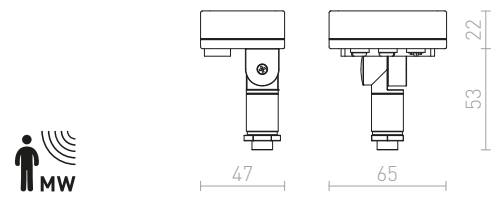

IP44

### DARK SENSOR

Interruptor Twilight para troca automática com sensor externo.

#### DARK SENSOR 5-50 LUX INCORPORADO

230 V IP44

G12758 branco

€ 5 %

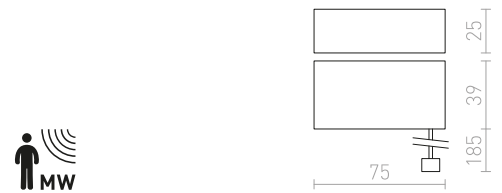

IP44

### DARK SENSOR

Interruptor Twilight para comutação automática em design ao ar livre.

#### DARK SENSOR 2-100 LUX DE SUPERFÍCIE

230 V IP44

G12759 preto

€ 7.80

G13528 branco

€ 7.80

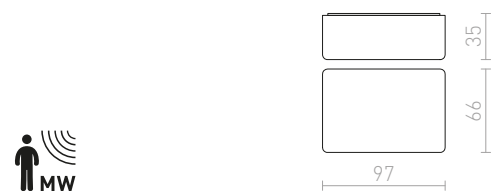

<b>1</b>			
<b>1F</b> calha		<b>532-533</b>	
<b>A</b>			
<b>ABAX</b> de pé		<b>638-639</b>	
<b>ACASA</b> embutida		<b>446-447</b>	
<b>ACUA</b> embutida		<b>400-401</b>	
<b>ADAGIO</b> na parede		<b>196-197</b>	
<b>AGATE</b> na parede		<b>250-251</b>	
<b>AGATE</b> teto		<b>138-139</b>	
<b>AGNETA</b> para calha monofásica suspenso		<b>554-555</b>	
<b>AGNETA</b> para calha trifásica suspenso		<b>522-523</b>	
<b>AGNETA</b> montado à superfície		<b>310-311</b>	
<b>AGNETA</b> suspenso		<b>64-65</b>	
<b>AIM</b> com braço articulado		<b>304-305</b>	
<b>AINO</b> suspenso		<b>30-31</b>	
<b>AKORD</b> embutido na parede		<b>722-723</b>	
<b>ALFA</b>		<b>740-741</b>	
<b>ALGOT</b> de mesa		<b>338-339</b>	
<b>ALLEGRO</b> DIMM teto		<b>154-155</b>	
<b>ALVIS</b> base candeeiro de pé		<b>612-613</b>	
<b>ALVIS</b> base candeeiro de mesa		<b>612-613</b>	
<b>ALVIS</b> Abajur candeeiro de mesa		<b>576-577</b>	
<b>ALVIS/AMBITUS</b> de pé		<b>352-353</b>	
<b>ALVIS/AMBITUS</b> de mesa		<b>322-323</b>	
<b>ALVIS/ILUSION</b> de pé		<b>352-353</b>	
<b>ALVIS/RIDICK</b> de pé		<b>352-353</b>	
<b>ALVIS/RON</b> de mesa		<b>324-325</b>	
<b>AMADEUS</b> na parede		<b>282-283</b>	
<b>AMARO</b> embutida		<b>474-475</b>	
<b>AMBER</b> na parede		<b>262-263</b>	
<b>AMBITUS</b> de pé		<b>352-353</b>	
<b>AMBITUS</b> abajur candeeiro de pé		<b>576-577</b>	
<b>AMBITUS</b> base candeeiro de pé		<b>612-613</b>	
<b>AMBITUS</b> base candeeiro de mesa		<b>612-613</b>	
<b>AMBITUS</b> abajur de mesa		<b>576-577</b>	
<b>AMBITUS/ALVIS</b> de mesa		<b>322-323</b>	
<b>AMENITY</b> na parede		<b>194-195</b>	
<b>AMICI</b> suspenso de silicone		<b>26-27</b>	
<b>AMIGA</b> DIMM		<b>394-395</b>	
<b>ANDANTE</b> na parede		<b>668-669</b>	
<b>ANIKA</b> de mesa		<b>342-343</b>	
<b>ANTE</b> na parede		<b>226-227</b>	
<b>APRIORI</b>		<b>398-399</b>	
<b>AQILA</b> na parede		<b>262-263</b>	
<b>ARANA</b> teto		<b>104-105</b>	
<b>ARAQ</b> na parede		<b>278-279</b>	
<b>ARAQ</b> para calha monofásica suspenso		<b>548-549</b>	
<b>ARAQ</b> para calha trifásica suspenso		<b>520-521</b>	
<b>ARAQ</b> suspenso		<b>64-65</b>	
<b>ASHLEY</b> na parede		<b>224-225</b>	
<b>ASPRO</b> abajur		<b>572-573</b>	
<b>ASTERI</b> suspenso		<b>76-77</b>	
<b>ASTERIA</b> embutida		<b>470-471</b>	
<b>ASTON</b> para calha trifásica		<b>522-523</b>	
<b>ASTON</b> suspenso		<b>66-67</b>	
<b>ASTOR</b>		<b>402-403</b>	
<b>ASTRAL</b> suspenso		<b>32-33</b>	
<b>ASTROMET</b> suspenso		<b>32-33</b>	
<b>ATHI</b> na parede		<b>238-239</b>	
<b>ATLANTA</b> de superfície		<b>238-239</b>	
<b>AWE</b> teto		<b>100-101</b>	
<b>AZRIA</b> suspenso		<b>42-43</b>	
<b>B</b>			
<b>BABADES</b> para calha monofásica		<b>552-553</b>	
<b>BABADES</b> para calha trifásica		<b>526-527</b>	
<b>BABADES</b> suspenso		<b>70-71</b>	
<b>BABU</b> suspenso		<b>40-41</b>	
<b>BABYMOON</b> suspenso ou de pé		<b>630-631</b>	
<b>BAHIA</b> para calha trifásica		<b>504-505</b>	
<b>BALEA</b> para armários		<b>190-191</b>	
<b>BAROQUE</b> na parede		<b>310-311</b>	
<b>BARRY</b> teto		<b>100-101</b>	
<b>BEACON</b> na parede		<b>630-631</b>	
<b>BEAT</b> abajur suspenso		<b>572-573</b>	
<b>BEAU MONDE</b> suspenso		<b>34-35</b>	
<b>BEEBA</b> para calha monofásica		<b>544-545</b>	
<b>BEEBA</b> para calha trifásica		<b>510-511</b>	
<b>BEJA</b> na parede		<b>684-685</b>	
<b>BELENOS</b> para calha monofásica		<b>540-541</b>	
<b>BELENOS</b> suspensa para calha monofásica		<b>552-553</b>	
<b>BELENOS</b> para calha trifásica		<b>508-509</b>	
<b>BELENOS</b> suspensa para calha trifásica		<b>526-527</b>	
<b>BELENOS</b> teto		<b>126-127</b>	
<b>BELENOS</b> suspenso		<b>62-63</b>	
<b>BELI</b> embutida		<b>396-397</b>	
<b>BELLA</b> embutida		<b>392-393</b>	
<b>BELLINI</b> para calha monofásica suspenso		<b>548-549</b>	
<b>BELLINI</b> para calha trifásica		<b>516-517</b>	
<b>BELLINI</b> suspenso		<b>42-43</b>	
<b>BEND</b> base arqueada na parede		<b>608-609</b>	
<b>BENITA</b> na parede		<b>228-229</b>	
<b>BERIT</b> tecto		<b>140-141</b>	
<b>BERMUDA</b> embutida		<b>398-399</b>	
<b>BIANCA</b> embutida		<b>416-417</b>	
<b>BIARITZ</b> na parede		<b>242-243</b>	
<b>BJORK</b> embutida		<b>448-449</b>	
<b>BLONDIE</b> para calha monofásica		<b>554-555</b>	
<b>BLONDIE</b> para calha trifásica		<b>522-523</b>	
<b>BLONDIE</b> suspenso		<b>66-67</b>	
<b>BLUESTAR</b> com espigão		<b>698-699</b>	
<b>BOB</b> com braço articulado		<b>306-307</b>	
<b>BOBO</b> na parede		<b>264-265</b>	
<b>BOBO</b> de pé		<b>642-643</b>	
<b>BODIE</b> na parede		<b>228-229</b>	
<b>BOGARD</b> extensor para suspensos		<b>62-63</b>	
<b>BOGARD</b> na parede		<b>286-287</b>	
<b>BOGARD</b> teto		<b>126-127</b>	
<b>BOGARD</b> suspenso		<b>62-63</b>	
<b>BOLLY</b> de superfície		<b>206-207</b>	
<b>BOLLY</b> teto		<b>106-107</b>	
<b>BOLLY</b> suspenso		<b>36-37</b>	
<b>BONDY</b> embutida		<b>438-439</b>	
<b>BONNIE</b> na parede		<b>634-635</b>	
<b>BONNIE</b> vertical		<b>634-635</b>	
<b>BONO</b> superfície		<b>114-115</b>	
<b>BORA</b> com espigão		<b>700-701</b>	
<b>BORA</b> na parede		<b>696-697</b>	
<b>BOSANNA</b> de pé		<b>632-633</b>	
<b>BOSANOVA</b> de pé		<b>632-633</b>	
<b>BOULOGNE</b> de pé		<b>354-355</b>	
<b>BOURDON</b> na parede		<b>682-683</b>	
<b>BRAN</b> embutida		<b>404-405</b>	
<b>BROADWAY</b> de mesa		<b>326-327</b>	
<b>BROADWAY</b> suspenso ajustável		<b>52-53</b>	
<b>BROADWAY</b> com braço suspenso		<b>54-55</b>	
<b>BRUXEL</b> na parede		<b>238-239</b>	
<b>BUCKY</b> para calha trifásica		<b>524-525</b>	
<b>BUCKY</b> suspenso		<b>24-25</b>	
<b>BUGSY</b> na parede		<b>316-317</b>	
<b>BUGSY</b> de pé		<b>370-371</b>	
<b>BUGSY</b> de mesa		<b>344-345</b>	
<b>BURTON</b> para calha trifásica		<b>528-529</b>	
<b>BURTON</b> suspenso		<b>16-17</b>	
<b>C</b>			
<b>CABOX</b> na parede		<b>674-675</b>	
<b>CADENZA</b> para calha monofásica		<b>540-541</b>	
<b>CADENZA</b> para calha trifásica		<b>506-507</b>	
<b>CALLUM</b> na parede		<b>210-211</b>	
<b>CAMARGUE</b> na parede		<b>660-661</b>	
<b>CAMINO</b> de mesa		<b>338-339</b>	
<b>CAMINO</b> de mesa com abajur		<b>338-339</b>	
<b>CAMINO</b> suspenso		<b>16-17</b>	
<b>CANTO</b> anel decorativo		<b>132-133</b>	
<b>CANTO</b> Foco sem abajur interno		<b>132-133</b>	
<b>CARISSIMA</b> suspenso		<b>70-71</b>	
<b>CARRE</b> na parede		<b>240-241</b>	
<b>CASSABLANCA</b> suspenso		<b>76-77</b>	
<b>CASSAMBA</b> na parede		<b>186-187</b>	
<b>CASSIE</b> na parede		<b>316-317</b>	
<b>CASUAL</b> abajur		<b>590-591</b>	
<b>CELEIA</b> montado à superfície		<b>310-311</b>	
<b>CELEIA</b> de mesa		<b>342-343</b>	
<b>CHIC</b> na parede		<b>228-229</b>	
<b>CHICAGO</b> na parede		<b>666-667</b>	
<b>CHLOE</b> na parede		<b>252-253</b>	
<b>CHOIX</b> na parede		<b>692-693</b>	
<b>CHOUPETTE</b> de parede ajustável		<b>278-279</b>	
<b>CHOUPETTE</b> para calha monofásica		<b>552-553</b>	
<b>CHOUPETTE</b> para calha trifásica		<b>520-521</b>	
<b>CHOUPETTE</b> suspenso		<b>26-27</b>	
<b>CINDY</b> suspenso		<b>32-33</b>	
<b>CIRA</b> teto		<b>98-99</b>	
<b>CLAIRE</b> na parede		<b>658-659</b>	
<b>CLANK</b> suspenso		<b>22-23</b>	
<b>CLUB</b> embutida		<b>470-471</b>	
<b>CLYDE</b> na parede		<b>634-635</b>	
<b>CLYDE</b> vertical		<b>634-635</b>	
<b>COCO</b> suspenso		<b>20-21</b>	
<b>COIMBRA</b> embutida		<b>428-429</b>	
<b>COLES</b> luz de teto		<b>120-121</b>	
<b>COLES</b> direcional de teto		<b>120-121</b>	
<b>COLIN</b> teto		<b>116-117</b>	
<b>COMODO</b> na parede		<b>672-673</b>	
<b>CONDU</b> teto		<b>126-127</b>	
<b>CONFETTI</b> suspenso		<b>20-21</b>	
<b>CONNOR</b> para calha monofásica		<b>542-543</b>	
<b>CONNOR</b> para calha trifásica		<b>506-507</b>	
<b>CONNOR</b> teto		<b>130-131</b>	
<b>CONNOR</b> abajur		<b>574-575</b>	
<b>CONNOR</b> abajures de mesa		<b>574-575</b>	
<b>CONNOR</b> abajur		<b>574-575</b>	
<b>COPA</b> para calha monofásica		<b>546-547</b>	
<b>COPA</b> para calha trifásica		<b>516-517</b>	
<b>COPA</b> suspenso		<b>64-65</b>	
<b>CORAZON</b>		<b>204-205</b>	
<b>CORDOBA</b> com espigão		<b>698-699</b>	
<b>COROA</b> suspenso		<b>44-45</b>	
<b>CORONA</b> suspenso		<b>42-43</b>	
<b>CORTINA</b> base candeeiro de pé		<b>616-617</b>	
<b>CORTINA</b> abajur de mesa		<b>616-617</b>	
<b>CORTINA/JAKARANDA</b> de pé		<b>362-363</b>	
<b>COSMO</b> com espigão		<b>700-701</b>	
<b>COWLEY</b> na parede		<b>230-231</b>	
<b>COZY</b> de mesa		<b>346-347</b>	
<b>CRESCENDO</b> na parede		<b>200-201</b>	
<b>CRESCENT</b> na parede		<b>232-233</b>	
<b>D</b>			
<b>DADA</b> embutida		<b>450-451</b>	
<b>DADOS</b> suspenso		<b>50-51</b>	
<b>DAFFY</b> na parede		<b>242-243</b>	
<b>DAG</b> embutida		<b>418-419</b>	

<b>DAISY</b> abajur suspenso	572-573	<b>ESSEX</b> na parede	248-249	<b>GUN</b> com espigão	698-699
<b>DAN</b> embutida	426-427	<b>ESTRA</b> suspenso	48-49		
<b>DANDY</b> embutida	418-419	<b>ETESIAN</b> de pé	360-361	<b>H</b>	
<b>DANTE</b> de pé	358-359	<b>EUTRAC</b> calha trifásica	490-491	<b>HAREN</b> de superfície	278-279
<b>DARIO</b> anel decorativo	128-129	<b>EZRA</b> suspenso	22-23	<b>HAY</b> na parede	234-235
<b>DARIO</b> para calha monofásica	542-543			<b>HEAVY DUTY</b> refletor exterior	702-703
<b>DARIO</b> para calha trifásica	506-507	<b>F</b>		<b>HEIDI</b> de mesa	338-339
<b>DARIO</b> teto	128-129	<b>FABIO</b> conjunto suspenso	602-603	<b>HEIDI</b> suspenso	14-15
<b>DARK SENSOR</b> de superfície	750-751	<b>FACA</b> embutida	722-723	<b>HEX</b> conjunto suspenso	598-599
<b>DARK SENSOR</b> incorporado	750-751	<b>FADO</b> na parede	280-281	<b>HIDE</b> na parede	668-669
<b>DEJAVU</b> embutida	480-481	<b>FADO</b> de pé	370-371	<b>HUDSON</b> na parede	218-219
<b>DELISA</b> abajur	580-581	<b>FADO</b> de mesa	346-347	<b>HUE DIMM</b> de teto	152-153
<b>DELTA</b> na parede	666-667	<b>FANCY</b> suspenso	28-29	<b>HUE DIMM</b> embutida	454-455
<b>DELTA</b> de superfície	664-665	<b>FANGIO</b> para calha trifásica	504-505	<b>HUE</b> teto	150-151
<b>DESMOND</b> na parede	250-251	<b>FAO</b> na parede	204-205	<b>HUE</b> embutida	452-453
<b>DESTY</b> para calha monofásica	554-555	<b>FAROS</b> exterior	704-705		
<b>DESTY</b> para calha trifásica	526-527	<b>FAX</b> para calha trifásica	512-513	<b>I</b>	
<b>DESTY</b> suspenso	64-65	<b>FIATLUX</b> suspenso	28-29	<b>ICAR</b> para calha monofásica	552-553
<b>DEZA</b> quadrado	112-113	<b>FIT</b> cabo PPM	618-619	<b>ICAR</b> suspenso	26-27
<b>DIDO</b> na parede	248-249	<b>FIT</b> cabo têxtil PPM	618-619	<b>ILLUSION</b> abajur	578-579
<b>DIFFUSER</b>	588-589	<b>FIT</b> cabo têxtil	618-619	<b>ILUSIA</b> suspenso	16-17
<b>DIFFUSER PRISM</b>	582-583	<b>FIZZ</b> direcional	440-441	<b>IMPERIA</b> na parede	196-197
<b>DINGO</b> direcional	424-425	<b>FLAP</b> na parede	308-309	<b>IMPERISO</b>	184-185
<b>DINGO</b> fixo	422-423	<b>FLATLINE</b> para calha trifásica	496-497	<b>INCA</b>	404-405
<b>DINGO</b> embutida	426-427	<b>FLORIDA</b> suspenso	14-15	<b>INEZ</b>	392-393
<b>DINO</b> direcional	426-427	<b>FLORIO</b> parede	202-203	<b>INTRO</b>	476-477
<b>DIREZZA</b> com espigão	698-699	<b>FOCUS DIMM</b> para calha monofásica	536-537	<b>IP-BOX</b>	748-749
<b>DIREZZA</b> na parede	694-695	<b>FOCUS DIMM</b> para calha trifásica	498-499	<b>IP-BOX</b> para sensor G12755	750-751
<b>DIXIE</b> na parede	688-689	<b>FOND</b> na parede	238-239	<b>IPSO</b>	428-429
<b>DOUBLE</b> abajur	586-587	<b>FORZA</b> para calha monofásica	540-541	<b>IPSO</b> fixo	428-429
<b>DRIVER</b>	746-747	<b>FORZA</b> para calha trifásica	508-509	<b>IRIA</b> embutida	464-465
<b>DRIVER DIMM</b>	748-749	<b>FOX</b> refletor exterior	694-695	<b>ISLA</b> embutida	404-405
<b>DUBLIN</b> de superfície	208-209	<b>FRISCO</b> na parede	304-305	<b>ITAKA</b> na parede	710-711
<b>DUDE</b> na parede	290-291	<b>FRISCO</b> de mesa	344-345		
<b>DUDE</b> para calha monofásica	540-541	<b>FRUTTI</b> para calha trifásica	528-529	<b>J</b>	
<b>DUDE</b> para calha trifásica	508-509	<b>FRUTTI</b> suspenso	18-19	<b>JACK</b> na parede	234-235
<b>DUDE</b> montado à superfície	290-291			<b>JACK</b> para calha trifásica	528-529
<b>DUGME</b>	292-293	<b>G</b>		<b>JACK</b> teto	118-119
<b>DURANT</b> na parede	662-663	<b>GAN</b> na parede	230-231	<b>JACK</b> suspenso	16-17
		<b>GAP</b> embutida	722-723	<b>JAKARANDA</b> abajur	578-579
<b>E</b>		<b>GARBO</b> de mesa	342-343	<b>JAMAICA</b> suspenso	24-25
<b>EDIKA</b> de pé	360-361	<b>GARDETTE</b> de pé	356-357	<b>JAMES</b> DIMM teto	140-141
<b>EDIKA</b> de mesa	330-331	<b>GARDETTE</b> de mesa	324-325	<b>JERSEY</b> na parede	218-219
<b>EIGHT</b> suspensa para calha trifásica	518-519	<b>GARDIEN</b> vertical	642-643	<b>JOLI</b> na parede	310-311
<b>EIGHT</b> teto	108-109	<b>GARNISH</b> para calha trifásica	518-519	<b>JOLI</b> de mesa	344-345
<b>EIGHT</b> suspenso	46-47	<b>GARNISH</b> suspenso	46-47	<b>JULIETTA</b> para calha monofásica	550-551
<b>EILEEN</b> teto	110-111	<b>GARRET</b> na parede	636-637	<b>JULIETTA</b> para calha trifásica	516-517
<b>EKE</b> na parede	304-305	<b>GARY</b> com espigão	700-701	<b>JULIETTA</b> suspenso	40-41
<b>EL PASO</b> de mesa	324-325	<b>GAVIN</b> na parede	670-671		
<b>ELECTRA</b>	430-431	<b>GAYA</b>	136-137	<b>K</b>	
<b>ELIA</b> na parede	632-633	<b>GERI</b> na parede	680-681	<b>KANE</b> na parede	678-679
<b>ELIA</b> de pé	632-633	<b>GIFT</b> suspenso	48-49	<b>KAY</b> embutida	416-417
<b>ELICA</b> exterior	466-467	<b>GIGI</b> na parede	680-681	<b>KAYA</b> na parede	308-309
<b>ELICA</b> embutida	466-467	<b>GINA</b> parede	228-229	<b>KEIG</b> teto	650-651
<b>ELISA</b> para calha monofásica	554-555	<b>GINA</b> teto	116-117	<b>KEITH</b> base de suporte com USB	614-615
<b>ELISA</b> para calha trifásica	530-531	<b>GINO</b> na parede	662-663	<b>KEITH/ALVIS</b> de mesa com USB	326-327
<b>ELISA</b> conjunto suspenso	600-601	<b>GIULIA</b> para calha monofásica	550-551	<b>KEITH/AMBITUS</b> de mesa com USB	328-329
<b>ELISEO</b> na parede	284-285	<b>GIULIA</b> para calha trifásica	520-521	<b>KEITH/DELISA</b> de mesa com USB	326-327
<b>ELISEO</b> montado à superfície	300-301	<b>GIULIA</b> suspenso	58-59	<b>KEITH/RON</b> de mesa com USB	334-335
<b>ELLA</b> suspenso	14-15	<b>GLAMOUR</b> suspenso	28-29	<b>KELLY</b> DIMM na parede	298-299
<b>ENCOMBRE</b> suspenso	20-21	<b>GLANS</b> na parede	212-213	<b>KELLY</b> DIMM semi embutida	296-297
<b>ENKI</b>	138-139	<b>GLOSSY</b>	302-303	<b>KELLY</b> DIMM teto	130-131
<b>ENZO</b> conjunto suspenso	602-603	<b>GLOSSY</b> em braço articulado	302-303	<b>KELLY</b> DIMM embutida	432-433
<b>EQUA</b>	398-399	<b>GOLDIE</b> suspenso	72-73	<b>KELLY</b> na parede	296-297
<b>ESICA</b> teto	108-109	<b>GORDIQ</b> embutida	478-479	<b>KELLY</b> para calha trifásica	512-513
<b>ESME</b> suspenso	18-19	<b>GORRA</b> teto	100-101	<b>KENNY</b> anel decorativo	288-289
<b>ESPLANADE</b> de pé	358-359	<b>GRANADA</b>	434-435	<b>KENNY</b> de superfície	288-289
<b>ESPLANADE</b> de mesa	330-331	<b>GRANDE</b> teto	96-97	<b>KENNY</b> teto	288-289
<b>ESPLANADE</b> suspenso	26-27	<b>GRANITA</b> na parede	228-229	<b>KICK</b> embutida	472-473





<b>PRIO LED</b> na parede	254-255	<b>SHARP</b> na parede	218-219	<b>TRICA</b> para calha trifásica	510-511
<b>PRODIGI</b> para calha trifásica	504-505	<b>SHOW</b> na parede	306-307	<b>TRIDENT</b> corpo	84-85
<b>PUC</b> fonte de luz	742-743	<b>SID</b> na parede	232-233	<b>TRIDENT</b> conjunto suspenso 2 pçs	84-85
<b>PULIRE</b> para calha monofásica	548-549	<b>SIENA</b> na parede	284-285	<b>TRIP</b> na parede	248-249
<b>PULIRE</b> suspenso	44-45	<b>SIENA</b> para calha monofásica	542-543	<b>TRIX</b> conjunto suspenso	604-605
<b>PURINA</b> para calha monofásica	544-545	<b>SINTRA</b> para calha trifásica	524-525	<b>TUBA</b> na parede	242-243
<b>PURINA</b> para calha trifásica	510-511	<b>SINTRA</b> suspenso	68-69	<b>TUBA</b> teto	132-133
		<b>SIV</b> superfície	682-683	<b>TUTTI</b> para calha trifásica	528-529
<b>Q</b>		<b>SLENDER</b> superfície	168-169	<b>TUTTI</b> suspenso	18-19
<b>QUADRA</b> teto	650-651	<b>SLENDER</b> embutida	460-461	<b>TWIST</b> na parede	254-255
<b>QUO</b> embutida	420-421	<b>SNAZZY</b>	128-129		
		<b>SOBER</b> embutida	442-443	<b>U</b>	
<b>R</b>		<b>SOCORRO</b> de superfície	168-169	<b>UKKO</b> na parede	250-251
<b>RADICAL</b> suspenso	14-15	<b>SOCORRO</b> embutida	460-461		
<b>RAGG</b> embutida	476-477	<b>SOLARIS</b> montado à superfície	122-123	<b>V</b>	
<b>RALLONG</b> base para teto	594-595	<b>SOLO</b> base de teto	604-605	<b>VADE</b>	132-133
<b>RALLONG</b> base para teto suspenso	594-595	<b>SONET</b> na parede	638-639	<b>VADIS</b> na parede	636-637
<b>RARA</b> suspenso	22-23	<b>SONET</b> vertical	638-639	<b>VADIS</b> vertical	636-637
<b>RASQ</b> embutido na parede	476-477	<b>SONNY</b> teto	652-653	<b>VALE</b> na parede	308-309
<b>REDO</b> direcional	316-317	<b>SONYA</b>	652-653	<b>VALTO</b> na parede	206-207
<b>REEM</b> na parede	246-247	<b>SORANO</b> na parede	644-645	<b>VALTO</b> de superfície	206-207
<b>RENO</b> na parede	708-709	<b>SORANO</b> teto	644-645	<b>VARIA</b> de pé	368-369
<b>RENO</b> de superfície	708-709	<b>SPECTACLE</b> superfície	114-115	<b>VECINO</b> na parede	670-671
<b>REWA</b> fixa	442-443	<b>SPIDER</b> conjunto suspensos	606-607	<b>VENICE</b> teto	104-105
<b>RIDICK</b> Abajur	578-579	<b>SPIDER</b> junta	606-607	<b>VERIA</b> na parede	666-667
<b>RIGA</b> teto	130-131	<b>SPLASH</b> embutida	402-403	<b>VERITA</b> na parede	230-231
<b>RIGA</b> suspenso	60-61	<b>SPRAY</b> embutida	434-435	<b>VERO</b> embutida	400-401
<b>RINA</b> na parede	642-643	<b>STIG</b> na parede	282-283	<b>VERSA</b> na parede	306-307
<b>RINA</b> de pé	642-643	<b>STIG</b> de pé	368-369	<b>VERSA</b> parede com abajur	220-221
<b>RINO</b> capa decorativa	390-391	<b>STIG</b> suspenso	60-61	<b>VERSINA</b> com abajur	220-221
<b>RINO</b>		<b>STRUCTURAL</b> de superfície	174-175	<b>VESCO</b> suspenso	24-25
embutido sem tampa	390-391	<b>STRUCTURAL</b> embutida	462-463	<b>VIENNA</b> de superfície	238-239
<b>RIO</b> embutida	468-469	<b>STRUCTURAL</b> suspenso	80-81	<b>VIP</b> dobrar	442-443
<b>RITZY</b> de pé	358-359	<b>SWAY</b> casa de banho	184-185	<b>VIPER</b> de mesa	346-347
<b>RITZY</b> de mesa	340-341	<b>SWING</b> topo de quadro	256-257	<b>VIRGO</b> na parede	672-673
<b>RIZZ</b>	724-725			<b>VOLCA</b> teto	120-121
<b>RODGE</b> teto	650-651	<b>T</b>		<b>VOLTERA</b> na parede	284-285
<b>ROLO</b> na parede	236-237	<b>TACO</b> teto	122-123		
<b>RON</b> na parede	214-215	<b>TAINA</b> com abajur	222-223	<b>W</b>	
<b>RON</b> abajur	582-583	<b>TAMPA</b> terminais 2 pçs	202-203	<b>WATERBOY</b>	390-391
<b>ROSITA</b> na parede	302-303	<b>TAMPA</b> na parede sem terminais	202-203	<b>WIM</b> na parede	236-237
<b>ROSITA</b> de pé	368-369	<b>TAPA</b> na parede	246-247	<b>WISH DIMM</b> para calha monofásica	538-539
<b>ROSITA</b> de mesa	344-345	<b>TAPIO</b> na parede	280-281	<b>WISH DIMM</b> para calha trifásica	500-501
<b>ROSS</b> refletor exterior	702-703	<b>TAPIO</b> de mesa	346-347	<b>WOODY</b> base candeeiro de mesa	610-611
<b>ROSTAM</b> na parede com USB	278-279	<b>TARIS</b> de superfície	654-655	<b>WOOP</b> na parede	660-661
<b>ROZA</b> na parede	246-247	<b>TECH</b> fixa	444-445		
		<b>TELO</b> na parede	674-675	<b>X</b>	
<b>S</b>		<b>TEMPO</b> abajur	588-589	<b>XYLO</b> na parede	672-673
<b>SAMMY</b> teto	110-111	<b>TERRA</b> embutida	724-725		
<b>SAMPO</b> na parede	660-661	<b>TESS</b> embutida	474-475	<b>Y</b>	
<b>SANSSOUCI</b> para calha trifásica	518-519	<b>THALIA</b> na parede	282-283	<b>YOLO</b> acima de espelho	190-191
<b>SANSSOUCI</b> suspenso	46-47	<b>TIARA</b> na parede	222-223		
<b>SARA</b> teto	102-103	<b>TICO</b> na parede	262-263	<b>Z</b>	
<b>SASSARI</b> teto	102-103	<b>TIM</b> embutida	444-445	<b>ZACK</b>	684-685
<b>SAVOY</b> para armários	190-191	<b>TIRAS</b> na parede	658-659	<b>ZALA</b> suspenso	22-23
<b>SCOTT</b> teto	654-655	<b>TITO</b> DIMM na parede	240-241	<b>ZANE</b> na parede	690-691
<b>SEGNO</b> embutida	464-465	<b>TITO</b> na parede	240-241	<b>ZARA</b> teto	102-103
<b>SELENA</b> na parede	216-217	<b>TOLEDO</b>	394-395	<b>ZAZA</b> na parede	680-681
<b>SELMA</b> na parede	682-683	<b>TOMBA</b> suspenso	46-47	<b>ZIZI</b> embutida	432-433
<b>SEMPRE</b> sensor teto	172-173	<b>TOPIC</b> direcional	442-443	<b>ZUMA</b> DIMM para calha trifásica	500-501
<b>SEMPRE</b> teto	170-171	<b>TOPTOP</b>	704-705	<b>ZUMBA</b> de mesa	334-335
<b>SENSOR</b>	750-751	<b>TOPTOP</b> solo	704-705	<b>ZURI</b> embutida	446-447
<b>SENSOR</b> acima do teto	750-751	<b>TORINO</b> na parede	252-253		
<b>SENSOR</b> para encaixe numa luminária	750-751	<b>TRAF0</b>	748-749		
<b>SENSOR</b>		<b>TRAF0</b> DIMM	746-747		
para montagem em lâmpadas exteriores	750-751	<b>TRAX</b> para calhas trifásicas	502-503		
<b>SENSOR</b> teto	750-751	<b>TREEZA</b> vertical	640-641		
<b>SENZA</b> teto	648-649	<b>TRICA</b> na parede	294-295		
<b>SHARM</b> embutida	386-387	<b>TRICA</b> para calha monofásica	544-545		

G11837	740-741	G13119	736-737	G13944	732-733	R10437	660-661	R11296	170-171		492-493
G11840	740-741	G13120	740-741	G13945	732-733	R10438	660-661	R11297	170-171	R11352	490-491
G11841	740-741	G13122	738-739	G13946	736-737	R10439	660-661	R11299	160-161		492-493
G11849	736-737	G13123	736-737	G13947	734-735	R10441	640-641	R11300	490-491	R11353	490-491
G11852	740-741	G13124	746-747	G13948	734-735	R10444	426-427		492-493		492-493
G11859	742-743	G13125	746-747	G13949	734-735	R10445	234-235	R11301	490-491	R11354	490-491
G11860	742-743	G13147	742-743	G13950	734-735	R10446	236-237		492-493		492-493
G11861	742-743	G13148	742-743	G13951	734-735	R10448	234-235	R11302	490-491	R11355	490-491
G11862	742-743	G13149	742-743	G13952	734-735	R10451	232-233		492-493		492-493
G11867	584-585	G13150	734-735	G13953	734-735	R10454	120-121	R11303	490-491	R11356	490-491
	586-587	G13151	736-737	G13960	740-741	R10455	234-235		492-493		492-493
G11868	582-583	G13152	734-735	G14018	748-749	R10465	236-237	R11304	490-491	R11357	494-495
	586-587	G13154	734-735	R10119	140-141	R10478	38-39		492-493	R11358	490-491
G11869	582-583	G13155	738-739	R10120	140-141	R10479	38-39	R11305	490-491		492-493
G11870	588-589	G13185	742-743	R10122	142-143	R10491	204-205		492-493	R11359	492-493
G11871	588-589	G13306	736-737	R10123	142-143	R10492	108-109	R11306	494-495		494-495
G12065	740-741	G13307	736-737	R10124	134-135	R10493	46-47	R11307	490-491	R11360	490-491
G12067	742-743	G13308	734-735	R10129	244-245	R10500	100-101		492-493		492-493
G12068	742-743	G13309	734-735	R10132	244-245	R10501	46-47	R11308	490-491	R11361	490-491
G12206	740-741	G13310	734-735		690-691	R10509	46-47		492-493		492-493
G12207	740-741	G13311	734-735	R10133	244-245	R10510	48-49	R11309	490-491	R11362	490-491
G12209	742-743	G13406	740-741		740-741	R10511	46-47		492-493		492-493
G12232	740-741	G13407	740-741	R10148	440-441	R10513	32-33	R11310	494-495	R11365	214-215
G12234	740-741	G13453	736-737	R10166	112-113	R10515	66-67	R11311	490-491	R11368	214-215
G12237	736-737	G13454	736-737	R10170	244-245	R10516	34-35		492-493	R11370	574-575
G12243	736-737	G13455	736-737		690-691	R10517	34-35	R11312	490-491	R11371	574-575
G12244	734-735	G13456	738-739	R10171	142-143	R10518	34-35		492-493	R11372	574-575
G12245	734-735	G13457	736-737		316-317	R10519	344-345	R11313	490-491	R11377	214-215
G12246	734-735	G13458	734-735	R10173	316-317	R10520	370-371		492-493	R11381	214-215
G12251	742-743	G13459	734-735	R10178	262-263	R10521	316-317	R11314	490-491	R11383	214-215
G12299	584-585	G13460	734-735	R10204	440-441	R10522	76-77		492-493	R11461	586-587
	586-587	G13461	734-735	R10212	134-135	R10527	700-701	R11315	490-491	R11462	582-583
G12300	582-583	G13462	734-735	R10217	440-441	R10530	698-699		492-493	R11463	582-583
	586-587	G13464	738-739	R10218	440-441	R10532	724-725	R11316	490-491	R11464	214-215
G12340	742-743	G13465	740-741	R10219	446-447	R10536	24-25		492-493	R11465	584-585
G12366	560-561	G13466	740-741	R10251	618-619	R10538	306-307	R11317	490-491	R11466	572-573
G12367	560-561	G13467	738-739	R10252	618-619	R10539	30-31		492-493	R11467	572-573
G12368	560-561	G13468	738-739	R10253	618-619	R10540	30-31	R11318	490-491	R11468	574-575
G12369	560-561	G13469	742-743	R10254	618-619	R10541	304-305		492-493	R11469	574-575
G12370	560-561	G13470	742-743	R10262	194-195	R10542	302-303	R11319	490-491	R11471	590-591
G12371	560-561	G13477	736-737	R10263	194-195	R10543	302-303		492-493	R11472	590-591
G12372	560-561	G13478	738-739	R10264	194-195	R10545	722-723	R11320	490-491	R11473	592-593
G12373	560-561	G13518	734-735	R10265	194-195	R10546	722-723		492-493	R11474	592-593
G12374	560-561	G13528	750-751	R10266	232-233	R10547	636-637	R11321	490-491	R11475	588-589
G12375	560-561	G13545	728-729	R10269	424-425	R10548	636-637	R11321	492-493	R11476	588-589
G12377	560-561	G13546	728-729	R10270	424-425	R10552	654-655	R11322	490-491	R11477	586-587
G12378	560-561	G13547	728-729	R10271	422-423	R10553	646-647		492-493	R11478	586-587
G12582	748-749	G13572	736-737	R10272	426-427	R10554	674-675	R11323	490-491	R11479	582-583
G12723	740-741	G13573	734-735	R10304	416-417	R10555	724-725	R11323	492-493	R11480	582-583
G12724	740-741	G13574	738-739	R10326	140-141	R10557	722-723	R11324	490-491	R11481	584-585
G12725	740-741	G13575	738-739	R10351	670-671	R10558	470-471		492-493	R11482	572-573
G12726	740-741	G13576	738-739	R10352	688-689		714-715	R11325	490-491	R11483	572-573
G12752	750-751	G13577	730-731	R10353	688-689	R10565	394-395		492-493	R11484	590-591
G12753	750-751	G13578	730-731	R10354	688-689	R10566	394-395	R11326	490-491	R11485	590-591
G12754	750-751	G13579	730-731	R10355	688-689	R10572	392-393		492-493	R11486	592-593
G12755	750-751	G13581	734-735	R10356	688-689	R10574	402-403	R11327	490-491	R11487	592-593
G12756	750-751	G13655	740-741	R10361	652-653	R10576	100-101		492-493	R11488	588-589
G12757	750-751	G13656	740-741	R10362	652-653	R10578	66-67	R11328	490-491	R11489	588-589
G12758	750-751	G13657	740-741	R10363	652-653	R10580	220-221		492-493	R11490	582-583
G12759	750-751	G13670	84-85	R10364	692-693		776-777	R11329	490-491	R11491	582-583
G12983	748-749		174-175	R10365	692-693	R10581	76-77		492-493	R11492	214-215
G12984	748-749	G13671	84-85	R10366	692-693	R10582	160-161	R11330	490-491	R11493	584-585
G12985	738-739		174-175	R10367	640-641	R10584	78-79		492-493	R11494	572-573
G13002	746-747	G13672	84-85	R10368	640-641	R10586	392-393	R11331	490-491	R11495	572-573
G13003	746-747	G13700	730-731	R10372	630-631	R10587	392-393		492-493	R11496	574-575
G13004	746-747	G13705	740-741	R10374	134-135	R10588	190-191	R11332	490-491	R11497	574-575
G13006	748-749	G13706	740-741	R10379	710-711	R10591	316-317		492-493	R11498	574-575
G13008	746-747	G13715	738-739	R10380	640-641	R10598	476-477	R11333	490-491	R11500	590-591
G13009	748-749	G13722	740-741	R10382	652-653	R10602	306-307		492-493	R11501	590-591
G13013	734-735	G13723	740-741	R10383	652-653	R10604	302-303	R11334	490-491	R11502	592-593
G13014	736-737	G13724	740-741	R10384	674-675	R10605	30-31		492-493	R11503	592-593
G13015	736-737	G13725	736-737	R10385	650-651	R10612	188-189	R11335	490-491	R11504	214-215
G13020	742-743	G13728	730-731	R10386	650-651	R10613	188-189		492-493	R11505	588-589
G13021	734-735	G13749	86-87	R10387	662-663	R10614	188-189	R11336	490-491	R11506	588-589
G13022	734-735	G13750	86-87	R10388	694-695	R10615	604-605		492-493	R11507	586-587
G13023	734-735	G13751	86-87	R10395	400-401	R10616	602-603	R11337	490-491	R11508	586-587
G13024	734-735	G13798	558-559	R10395/12	400-401	R10617	602-603		492-493	R11509	214-215
G13026	736-737	G13799	558-559	R10398	680-681	R10618	602-603	R11338	490-491	R11510	584-585
G13027	736-737	G13800	556-557	R10399	680-681	R10620	26-27		492-493	R11511	592-593
G13028	736-737	G13801	556-557	R10400	248-249	R10622	602-603	R11339	490-491	R11512	214-215
G13029	736-737		558-559	R10401	246-247	R10623	602-603		492-493	R11513	588-589
G13032	742-743	G13802	556-557	R10402	444-445	R10624	602-603	R11340	490-491	R11514	588-589
G13033	742-743		558-559	R10404	444-445	R10625	602-603		492-493	R11515	586-587
G13034	738-739	G13803	556-557	R10407	400-401	R10626	76-77	R11341	494-495	R11516	586-587
G13035	738-739		558-559	R10418	416-417	R10639	466-467	R11342	494-495	R11517	582-583
G13036	738-739	G13804	556-557	R10419	416-417		716-717	R11343	494-495	R11518	582-583
G13037	738-739		558-559	R10420	442-443	R10640	512-513	R11344	494-495	R11519	214-215
G13038	738-739	G13806	746-747	R10421	442-443	R10641	512-513	R11345	494-495	R11520	584-585
G13040	740-741	G13820	556-557	R10427	698-699	R10644	512-513	R11346	490-491	R11522	214-215
G13041	740-741	G13828	738-739	R10428	112-113	R10645	512-513		492-493	R11523	588-589
G13043	738-739	G13829	738-739	R10428	648-649	R11169	666-667	R11347	490-491	R11524	588-589
G13044	738-739	G13830	738-739	R10429	112-113	R11170	638-639		492-493	R11535	586-587
G13045	738-739	G13831	736-737	R10429	648-649	R11171	638-639	R11348	490-491	R11541	592-593
G13047	738-739	G13832	736-737	R10430	11						

R11549	584-585		R11753	670-671	R11909	598-599	R12046	428-429	R12267	532-533	R12365	230-231
R11550	592-593			694-695	R11910	598-599	R12047	134-135		534-535	R12379	338-339
R11551	588-589			702-703	R11911	598-599	R12048	100-101	R12268	532-533	R12380	14-15
R11552	588-589	R11754		702-703	R11912	598-599	R12050	430-431		534-535	R12381	20-21
R11553	586-587	R11755		702-703	R11913	598-599	R12052	430-431	R12269	532-533	R12382	20-21
R11554	586-587			704-705	R11914	598-599	R12053	430-431		534-535	R12383	20-21
R11555	582-583	R11756		46-47	R11915	598-599	R12054	32-33	R12270	532-533	R12384	20-21
R11556	582-583	R11758		306-307	R11916	598-599	R12055	42-43		534-535	R12388	580-581
R11557	214-215	R11759		346-347	R11917	598-599	R12056	42-43	R12271	532-533	R12389	580-581
R11558	584-585	R11761		32-33	R11918	598-599	R12057	66-67		534-535	R12392	578-579
R11559	592-593	R11765		70-71	R11919	598-599	R12059	504-505	R12272	532-533	R12393	578-579
R11560	214-215	R11766		70-71	R11920	598-599	R12060	504-505		534-535	R12394	66-67
R11561	588-589	R11768		512-513	R11922	598-599	R12062	462-463	R12273	532-533	R12395	66-67
R11562	588-589	R11769		512-513	R11923	598-599	R12063	162-163		534-535	R12396	68-69
R11563	586-587	R11770		128-129	R11924	598-599	R12064	174-175	R12274	532-533	R12397	68-69
R11564	586-587	R11771		128-129	R11925	598-599	R12072	490-491		534-535	R12398	190-191
R11565	582-583	R11772		128-129	R11926	598-599		492-493	R12275	532-533	R12399	190-191
R11566	582-583			314-315	R11927	598-599	R12073	490-491		534-535	R12400	190-191
R11567	214-215	R11773		128-129	R11929	598-599		492-493	R12276	532-533	R12401	192-193
R11568	584-585			314-315	R11930	598-599	R12074	490-491		534-535	R12402	192-193
R11569	592-593	R11774		594-595	R11931	598-599		492-493	R12277	532-533	R12403	192-193
R11570	214-215	R11775		594-595	R11932	598-599	R12076	292-293		534-535	R12404	192-193
R11573	582-583	R11776		594-595	R11933	598-599	R12077	292-293	R12278	532-533	R12405	192-193
R11574	582-583	R11777		594-595	R11934	598-599	R12078	292-293		534-535	R12406	192-193
R11575	214-215	R11778		596-597	R11935	598-599	R12081	70-71	R12279	532-533	R12407	200-201
R11576	584-585	R11779		596-597	R11936	598-599	R12082	70-71		534-535	R12409	200-201
R11577	572-573	R11780		596-597	R11937	598-599	R12083	70-71	R12280	532-533	R12412	502-503
R11578	572-573	R11781		596-597	R11938	598-599	R12084	70-71		534-535	R12413	502-503
R11579	574-575	R11782		596-597	R11939	598-599	R12085	64-65	R12281	532-533	R12416	14-15
R11580	574-575	R11783		596-597	R11940	598-599	R12086	64-65		534-535	R12418	26-27
R11581	574-575	R11784		596-597	R11941	598-599	R12091	254-255	R12282	532-533	R12420	632-633
R11582	590-591	R11785		596-597	R11942	598-599	R12092	254-255		534-535	R12421	632-633
R11583	590-591	R11786		596-597	R11943	598-599	R12094	518-519	R12283	532-533	R12434	170-171
R11584	582-583	R11787		596-597	R11944	598-599	R12095	518-519		534-535	R12439	170-171
R11585	582-583	R11788		596-597	R11945	598-599	R12100	522-523	R12284	532-533	R12440	172-173
R11586	214-215	R11789		596-597	R11946	672-673	R12101	524-525		534-535	R12441	172-173
R11587	584-585	R11791		610-611	R11947	642-643	R12102	524-525	R12285	532-533	R12442	172-173
R11588	572-573	R11795		594-595	R11948	702-703	R12103	528-529		534-535	R12443	172-173
R11589	572-573	R11796		594-595	R11949	708-709	R12106	530-531	R12286	532-533	R12446	72-73
R11590	574-575	R11797		594-595	R11950	708-709	R12107	530-531		534-535	R12447	72-73
R11591	574-575	R11798		594-595	R11951	708-709	R12108	530-531	R12287	532-533	R12448	130-131
R11592	574-575	R11799		604-605	R11953	708-709	R12109	530-531		534-535	R12449	130-131
R11593	590-591	R11800		574-575	R11954	708-709	R12110	530-531	R12288	532-533	R12450	130-131
R11594	590-591	R11802		584-585	R11957	118-119	R12111	530-531		534-535	R12451	130-131
R11597	574-575	R11803		584-585	R11959	228-229	R12112	530-531	R12289	532-533	R12452	130-131
R11599	586-587	R11804		584-585	R11960	234-235	R12113	530-531		534-535	R12453	130-131
R11600	586-587	R11805		584-585	R11963	704-705	R12114	530-531	R12290	532-533	R12454	130-131
R11607	582-583	R11806		584-585	R11964	674-675	R12115	154-155		534-535	R12455	130-131
R11608	582-583	R11809		584-585	R11967	114-115	R12120	160-161	R12291	532-533	R12458	60-61
R11611	592-593	R11810		584-585		654-655	R12121	160-161		534-535	R12459	60-61
R11616	592-593	R11811		584-585	R11968	114-115	R12181	460-461	R12292	532-533	R12461	280-281
R11634	592-593	R11812		590-591		654-655	R12187	460-461		534-535	R12462	346-347
R11639	592-593	R11813		590-591	R11973	336-337	R12196	100-101	R12293	532-533		370-371
R11676	16-17	R11814		590-591	R11976	218-219	R12197	100-101		534-535	R12464	332-333
R11678	48-49	R11815		590-591	R11978	54-55	R12198	108-109	R12294	532-533	R12465	332-333
R11679	48-49	R11816		590-591	R11982	222-223	R12199	108-109		534-535	R12466	364-365
R11680	116-117	R11817		590-591	R11983	336-337	R12201	100-101	R12295	532-533	R12467	364-365
R11682	390-391	R11819		590-591	R11984	366-367	R12202	100-101		534-535	R12470	360-361
R11683	390-391	R11820		590-591	R11986	326-327	R12214	618-619	R12296	532-533	R12471	122-123
R11684	390-391	R11822		590-591	R11989	52-53	R12216	618-619		534-535	R12473	280-281
R11685	390-391	R11823		64-65	R11990	616-617	R12217	196-197	R12297	532-533	R12474	346-347
R11686	390-391	R11824		64-65	R11991	616-617	R12218	196-197		534-535	R12475	370-371
R11687	72-73	R11872		600-601	R11992	614-615	R12219	196-197	R12298	532-533	R12476	282-283
R11688	72-73	R11873		600-601	R11993	198-199	R12220	200-201		534-535	R12477	52-53
R11689	72-73	R11874		600-601	R11996	198-199	R12222	618-619		510-511	R12478	52-53
R11690	72-73	R11875		600-601	R11998	198-199	R12223	618-619	R12305	510-511	R12479	54-55
R11691	72-73	R11876		600-601	R12006	510-511	R12224	618-619	R12306	510-511	R12480	224-225
R11692	72-73	R11877		600-601	R12007	510-511	R12225	618-619	R12307	510-511	R12481	218-219
R11694	502-503	R11878		600-601	R12009	444-445	R12226	618-619	R12308	544-545	R12482	224-225
R11698	68-69	R11879		600-601	R12010	680-681	R12227	618-619	R12310	544-545	R12482	224-225
R11699	68-69	R11880		600-601	R12012	692-693	R12228	618-619	R12311	510-511	R12483	26-27
R11700	68-69	R11881		600-601	R12013	474-475	R12229	618-619	R12312	510-511	R12484	330-331
R11701	68-69	R11882		600-601	R12013	716-717	R12230	618-619	R12313	510-511	R12485	358-359
R11706	32-33	R11883		600-601	R12014	474-475	R12254	532-533	R12314	544-545	R12486	340-341
R11707	68-69	R11884		600-601		716-717		534-535	R12316	544-545	R12487	358-359
R11715	38-39	R11885		600-601	R12015	474-475	R12255	532-533	R12317	510-511	R12488	324-325
R11724	512-513	R11886		600-601		716-717		534-535	R12318	510-511	R12489	356-357
R11725	390-391	R11887		600-601	R12018	666-667	R12256	532-533	R12319	510-511	R12493	62-63
R11726	390-391	R11888		600-601	R12021	686-687		534-535	R12320	544-545	R12494	62-63
R11727	390-391	R11889		600-601	R12022	684-685	R12257	532-533	R12321	544-545	R12495	62-63
R11728	390-391	R11890		600-601	R12024	470-471		534-535	R12322	544-545	R12496	62-63
R11729	390-391	R11891		600-601	R12024	714-715	R12258	532-533	R12332	296-297	R12497	126-127
R11730	390-391	R11892		600-601	R12025	700-701		534-535	R12333	296-297		312-313
R11731	442-443	R11893		600-601	R12027	684-685	R12259	532-533	R12334	296-297	R12498	126-127
R11732	446-447	R11894		600-601	R12028	686-687		534-535	R12335	296-297		312-313
R11733	402-403	R11895		600-601	R12029	470-471	R12260	532-533	R12336	296-297	R12499	126-127
R11734	402-403	R11896		600-601	R12029	714-715		534-535	R12337	296-297		312-313
R11735	402-403	R11897		600-601	R12030	470-471	R12261	532-533	R12338	512-513	R12500	126-127
R11736	402-403	R11898		600-601	R12030	714-715		534-535	R12339	512-513		312-313
R11738	442-443	R11899		600-601	R12033	314-315	R12262	532-533	R12350	468-469	R12502	286-287
R11740	390-391	R11900		600-601	R12033	694-695	</					

R12515	642-643		R12615	712-713	R12743	246-247	R12888	450-451	R13067	458-459	R13243	386-387
R12516	134-135			472-473	R12744	246-247	R12889	450-451	R13068	458-459	R13244	386-387
R12517	134-135			712-713	R12745	132-133	R12890	450-451	R13069	458-459	R13245	386-387
R12525	654-655	R12616		472-473	R12746	398-399	R12894	124-125	R13070	458-459	R13246	386-387
R12527	428-429			712-713	R12747	398-399	R12896	306-307	R13071	458-459	R13247	386-387
R12528	466-467	R12618		472-473	R12748	446-447	R12897	306-307	R13072	458-459	R13248	386-387
	714-715			712-713	R12749	398-399	R12898	308-309	R13073	152-153	R13249	386-387
R12529	466-467	R12619		472-473	R12750	446-447	R12900	418-419	R13076	152-153	R13250	388-389
	716-717			712-713	R12751	118-119	R12901	204-205	R13077	152-153	R13251	388-389
R12530	480-481	R12621		472-473	R12760	452-453		260-261	R13078	152-153	R13252	388-389
	720-721			712-713	R12761	452-453	R12902	204-205	R13082	152-153	R13253	388-389
R12531	480-481	R12626		638-639	R12763	452-453	R12902	260-261	R13083	166-167	R13254	388-389
	720-721	R12627		476-477	R12764	452-453	R12903	202-203	R13084	166-167	R13255	388-389
R12533	478-479			716-717	R12765	452-453		260-261	R13085	166-167	R13256	388-389
	718-719	R12628		476-477	R12766	452-453	R12904	202-203	R13086	166-167	R13257	388-389
R12534	478-479			716-717	R12767	452-453		260-261	R13087	166-167	R13258	388-389
	718-719	R12633		130-131	R12768	452-453	R12905	202-203	R13088	166-167	R13259	388-389
R12535	478-479	R12634		130-131	R12770	452-453	R12906	202-203	R13089	166-167	R13260	388-389
	718-719	R12635		432-433	R12771	452-453	R12907	202-203	R13090	166-167	R13261	388-389
R12536	478-479	R12636		432-433	R12772	452-453	R12908	202-203	R13091	166-167	R13262	388-389
	718-719	R12637		296-297	R12773	452-453	R12911	398-399	R13104	298-299	R13263	388-389
R12537	478-479			432-433	R12774	452-453	R12912	288-289	R13105	298-299	R13264	388-389
	718-719	R12638		296-297	R12775	456-457	R12913	288-289	R13106	298-299	R13267	158-159
R12538	478-479			432-433	R12776	456-457	R12914	288-289	R13107	298-299	R13268	158-159
	718-719	R12639		194-195	R12777	456-457	R12915	288-289	R13108	298-299	R13271	28-29
R12539	262-263	R12640		194-195	R12778	456-457	R12916	288-289	R13109	298-299	R13275	30-31
	710-711	R12641		194-195	R12780	456-457	R12917	288-289	R13113	576-577	R13276	18-19
R12540	262-263	R12651		226-227	R12781	456-457	R12918	288-289	R13113	610-611	R13278	572-573
	710-711	R12652		226-227	R12782	456-457	R12919	288-289	R13114	576-577	R13279	572-573
R12541	262-263	R12654		608-609	R12783	456-457	R12920	288-289	R13114	610-611	R13280	24-25
	710-711	R12655		468-469	R12784	456-457	R12921	288-289	R13126	420-421	R13281	572-573
R12542	262-263	R12656		468-469	R12785	456-457	R12922	288-289	R13127	454-455	R13282	226-227
	710-711	R12657		404-405	R12786	456-457	R12923	288-289	R13128	454-455	R13283	340-341
R12544	262-263	R12659		404-405	R12787	456-457	R12924	288-289	R13130	454-455	R13284	218-219
	710-711	R12660		404-405	R12788	456-457	R12925	288-289	R13131	454-455		608-609
R12545	262-263	R12661		390-391	R12789	456-457	R12926	288-289	R13132	458-459	R13285	20-21
	710-711			724-725	R12790	150-151	R12927	616-617	R13133	458-459	R13288	428-429
R12547	262-263	R12663		44-45	R12791	150-151	R12930	616-617	R13134	458-459	R13289	18-19
	710-711	R12664		44-45	R12792	150-151	R12931	16-17	R13135	458-459	R13290	18-19
R12548	636-637	R12665		330-331	R12794	150-151	R12932	56-57	R13137	152-153	R13293	338-339
R12551	238-239	R12666		360-361	R12795	150-151	R12933	56-57	R13138	152-153	R13294	338-339
	656-657	R12667		136-137	R12798	150-151	R12934	56-57	R13139	152-153	R13295	338-339
	666-667	R12668		136-137	R12799	150-151	R12935	56-57	R13141	152-153	R13296	16-17
R12552	248-249	R12669		132-133	R12800	150-151	R12940	344-345	R13142	166-167	R13297	16-17
R12552	688-689	R12670		128-129	R12804	150-151	R12942	304-305	R13143	166-167	R13298	14-15
R12553	248-249	R12672		138-139	R12805	164-165	R12943	308-309	R13144	166-167	R13300	434-435
	688-689	R12673		138-139	R12806	164-165	R12944	304-305	R13145	166-167	R13302	434-435
R12555	250-251	R12674		354-355	R12807	164-165	R12945	304-305	R13157	148-149	R13303	612-613
	688-689	R12675		342-343	R12808	164-165	R12947	610-611	R13158	158-159	R13304	612-613
R12556	240-241	R12677		250-251	R12810	164-165	R12949	184-185	R13163	538-539	R13315	22-23
	676-677	R12678		250-251	R12811	164-165	R12950	184-185	R13164	148-149	R13316	22-23
R12557	240-241	R12679		248-249	R12812	164-165		256-257	R13171	502-503	R13319	22-23
	676-677	R12680		248-249	R12813	164-165	R12951	184-185	R13172	502-503	R13320	334-335
R12559	662-663	R12681		136-137	R12814	164-165		256-257	R13173	502-503	R13321	22-23
R12560	668-669	R12682		136-137	R12815	164-165	R12954	256-257	R13177	148-149	R13324	330-331
R12561	668-669	R12684		136-137	R12816	164-165	R12955	220-221	R13178	148-149	R13325	330-331
R12562	672-673	R12685		470-471	R12817	164-165		276-277	R13182	60-61	R13328	74-75
R12563	664-665			714-715	R12818	164-165	R12956	222-223	R13183	60-61		144-145
R12564	664-665	R12686		470-471	R12823	504-505		276-277	R13184	60-61	R13329	74-75
R12565	664-665			714-715	R12824	504-505	R12957	222-223	R13201	554-555		144-145
R12566	664-665	R12687		466-467	R12825	238-239		280-281	R13202	554-555	R13330	74-75
R12567	666-667	R12688		466-467		656-657	R12960	690-691	R13203	554-555	R13331	74-75
R12568	662-663	R12690		474-475	R12827	250-251	R12963	460-461	R13204	554-555	R13332	74-75
R12569	662-663	R12691		692-693		688-689	R12965	460-461	R13205	546-547		144-145
R12571	692-693	R12695		432-433	R12829	686-687	R12973	168-169	R13206	546-547	R13333	74-75
R12573	252-253	R12696		432-433	R12831	248-249	R12977	544-545	R13207	516-517		144-145
	660-661	R12697		436-437		686-687	R12978	544-545	R13208	516-517	R13334	74-75
R12574	252-253	R12699		436-437	R12832	248-249	R12982	696-697	R13209	548-549		144-145
	660-661	R12700		436-437		686-687	R12986	310-311	R13210	548-549	R13335	74-75
R12575	246-247	R12702		436-437	R12839	126-127	R12989	368-369	R13211	554-555	R13337	186-187
R12576	474-475	R12703		436-437	R12840	126-127	R12990	60-61	R13212	552-553	R13338	324-325
	716-717	R12704		436-437	R12842	146-147	R12991	60-61	R13213	552-553	R13339	612-613
R12577	474-475	R12705		436-437	R12843	146-147	R12992	60-61	R13214	552-553	R13340	612-613
	716-717	R12707		434-435	R12844	146-147	R12993	538-539	R13215	526-527	R13344	578-579
R12578	696-697	R12709		436-437	R12845	146-147	R12994	538-539	R13216	526-527	R13345	18-19
R12579	698-699	R12710		436-437	R12846	76-77	R12995	502-503	R13217	526-527	R13346	540-541
R12580	700-701	R12711		436-437	R12848	156-157	R12996	502-503	R13218	522-523	R13347	540-541
R12581	192-193	R12712		436-437	R12849	156-157	R12997	502-503	R13221	384-385	R13348	506-507
R12583	604-605	R12713		436-437	R12850	156-157	R12998	232-233	R13222	384-385	R13349	506-507
R12584	604-605	R12716		394-395	R12851	156-157	R12999	228-229	R13223	384-385	R13350	504-541
R12585	242-243	R12717		394-395	R12852	78-79	R13000	504-505	R13224	384-385	R13351	504-541
	684-685	R12718		82-83	R12853	78-79	R13048	70-71	R13225	384-385	R13352	508-509
R12587	252-253	R12719		82-83	R12854	438-439	R13049	584-585	R13226	384-385	R13353	508-509
R12589	238-239	R12720		82-83	R12856	438-439	R13050	584-585	R13227	384-385	R13360	24-25
R12590	246-247	R12721		82-83	R12857	438-439	R13051	582-583	R13228	384-385	R13361	140-141
R12591	246-247	R12722		462-463	R12858	438-439	R13052	582-583	R13229	384-385	R13362	140-141
R12592	242-243	R12729		136-137	R12870	450-451	R13053	454-455	R13230	384-385	R13363	126-127
R12593	242-243	R12730		136-137	R12871	450-451	R13054	454-455	R13231	384-385		312-313
R12595	252-253	R12731		136-137	R12872	450-451	R13055	454-455	R13232	384-385		126-127
R12596	238-239	R12732		136-137	R12875	450-451	R13056	454-455	R13233	384-385	R13364	312-313
R12598	248-249	R12733		136-137	R12876	450-451	R13058	454-455	R13234	384-38		

R13374	294-295	R13554	188-189	R13652	42-43	R13776	500-501	R13897	64-65	R14004	408-409
R13375	294-295		258-259	R13653	358-359	R13777	62-63	R13898	64-65	R14005	412-413
R13376	294-295	R13555	184-185	R13654	642-643	R13778	62-63	R13899	64-65	R14006	414-415
R13377	208-209		258-259	R13658	42-43	R13779	312-313	R13900	64-65	R14007	410-411
	274-275	R13556	310-311	R13660	368-369	R13780	312-313	R13901	310-311	R14008	410-411
R13378	208-209	R13558	344-345	R13661	220-221	R13781	536-537	R13902	310-311	R14009	410-411
	274-275	R13559	682-683		276-277	R13782	536-537	R13903	342-343	R14010	414-415
R13379	208-209	R13560	682-683	R13662	220-221	R13783	500-501	R13904	342-343	R14011	406-407
	274-275	R13561	680-681		276-277	R13784	500-501	R13905	342-343	R14012	412-413
R13380	208-209	R13562	246-247	R13663	328-329	R13788	14-15	R13906	342-343	R14013	412-413
	274-275		670-671	R13664	328-329	R13789	116-117	R13907	338-339	R14014	414-415
R13391	446-447	R13563	658-659	R13665	366-367	R13790	118-119	R13908	58-59	R14015	414-415
R13394	356-357	R13564	658-659	R13666	366-367	R13791	116-117	R13909	58-59	R14016	406-407
R13397	24-25	R13565	658-659	R13667	394-395	R13792	228-229	R13910	58-59	R14017	408-409
R13398	28-29	R13566	464-465	R13668	394-395		678-679	R13911	58-59	R14019	50-51
R13401	452-453		722-723	R13676	96-97	R13793	678-679	R13912	58-59	R14020	50-51
R13402	452-453	R13567	464-465	R13677	96-97	R13794	678-679	R13913	58-59	R14021	50-51
R13404	150-151		722-723	R13678	96-97	R13795	120-121	R13914	284-285	R14022	50-51
R13405	150-151	R13568	700-701	R13679	96-97	R13796	646-647		300-301	R14023	50-51
R13417	578-579	R13569	658-659	R13680	98-99	R13797	646-647	R13915	284-285	R14024	50-51
R13418	28-29	R13570	148-149	R13681	98-99	R13807	122-123		300-301	R14025	50-51
R13419	28-29	R13571	278-279	R13682	104-105	R13808	122-123	R13916	300-301	R14026	50-51
R13423	280-281	R13582	448-449	R13683	104-105	R13809	616-617	R13917	300-301	R14027	50-51
R13429	346-347	R13583	448-449	R13684	104-105	R13814	516-517	R13918	290-291	R14028	50-51
R13430	396-397	R13584	448-449		124-125	R13815	518-519	R13919	290-291	R14029	50-51
R13432	396-397	R13585	448-449	R13685	104-105	R13816	528-529	R13920	290-291	R14030	50-51
R13433	228-229	R13586	448-449		124-125	R13817	528-529	R13921	290-291	R14031	340-341
R13435	230-231	R13587	448-449	R13686	102-103	R13818	528-529	R13922	290-291	R14032	340-341
R13436	236-237	R13588	448-449	R13687	102-103	R13819	524-525	R13923	290-291	R14033	326-327
R13437	614-615	R13589	448-449	R13688	102-103	R13821	50-51	R13924	290-291	R14034	332-333
R13438	120-121	R13590	448-449	R13689	106-107	R13822	50-51	R13925	290-291	R14035	328-329
R13439	724-725	R13591	448-449	R13690	106-107	R13823	50-51	R13926	540-541	R14036	334-335
R13441	454-455	R13598	400-401	R13691	206-207	R13824	44-45	R13927	540-541	R14037	326-327
R13442	454-455	R13599	400-401		272-273	R13825	44-45	R13928	508-509	R14038	326-327
R13444	152-153	R13600	400-401	R13692	36-37	R13826	40-41	R13929	508-509	R14039	328-329
R13445	152-153	R13601	400-401	R13693	106-107	R13827	40-41	R13930	632-633	R14040	322-323
R13446	538-539	R13602	392-393	R13694	106-107	R13841	576-577	R13931	632-633	R14041	322-323
R13450	110-111	R13603	404-405	R13695	206-207	R13842	238-239	R13932	632-633	R14042	324-325
	648-649	R13604	398-399		272-273	R13843	148-149	R13933	264-265	R14043	352-353
R13451	110-111	R13605	404-405	R13696	206-207	R13844	148-149		706-707	R14044	352-353
	648-649	R13606	110-111		272-273	R13848	538-539	R13934	264-265	R14045	352-353
R13452	110-111	R13607	110-111	R13697	114-115	R13849	538-539		706-707	R14046	352-353
	648-649	R13608	110-111	R13698	114-115	R13851	158-159	R13935	264-265	R14047	332-333
R13471	132-133	R13609	250-251	R13703	206-207	R13852	188-189		706-707	R14048	332-333
R13472	132-133	R13609	674-675	R13703	272-273		258-259	R13936	642-643	R14049	332-333
R13473	132-133	R13610	250-251	R13704	206-207	R13853	186-187	R13938	158-159	R14050	332-333
R13474	132-133		674-675		272-273		258-259	R13939	158-159	R14051	332-333
R13475	132-133	R13611	250-251	R13707	162-163	R13854	518-519	R13940	60-61	R14052	332-333
R13476	132-133		674-675	R13708	162-163	R13855	516-517	R13941	282-283	R14053	332-333
R13479	146-147	R13612	278-279	R13709	80-81	R13856	516-517	R13942	368-369	R14054	332-333
R13480	146-147	R13613	278-279	R13710	80-81	R13857	526-527	R13943	466-467	R14055	334-335
R13481	146-147	R13614	630-631	R13711	162-163	R13858	526-527	R13945	466-467	R14056	334-335
R13482	146-147	R13615	254-255	R13712	162-163	R13859	524-525	R13956	466-467	R14057	334-335
R13483	146-147		656-657	R13713	80-81	R13860	550-551	R13957	466-467	R14058	334-335
R13484	146-147		672-673	R13714	80-81	R13861	550-551	R13958	474-475	R14059	334-335
R13485	146-147	R13616	254-255	R13720	552-553	R13862	552-553	R13963	548-549	R14060	334-335
R13486	146-147		656-657	R13721	520-521	R13863	552-553	R13964	546-547	R14061	334-335
R13487	156-157	R13616	672-673	R13726	554-555	R13864	564-565	R13965	546-547	R14062	334-335
R13488	156-157	R13617	704-705	R13730	154-155	R13865	564-565	R13966	546-547	R14063	336-337
R13489	156-157	R13618	704-705	R13731	496-497	R13866	564-565	R13967	514-515	R14064	336-337
R13490	156-157	R13619	600-661	R13732	496-497	R13867	128-129	R13968	514-515	R14065	354-355
R13492	606-607	R13620	476-477	R13735	186-187		314-315	R13969	514-515	R14066	354-355
R13493	606-607		718-719		258-259	R13868	128-129	R13970	554-555	R14067	356-357
R13494	606-607	R13621	476-477	R13736	240-241		314-315	R13971	554-555	R14068	356-357
R13495	606-607	R13621	718-719		676-677	R13869	128-129	R13972	554-555	R14069	362-363
R13496	130-131	R13622	648-649	R13737	240-241		314-315	R13973	554-555	R14070	362-363
R13497	542-543	R13623	648-649		676-677	R13870	542-543	R13974	522-523	R14071	362-363
R13498	542-543	R13624	650-651	R13738	240-241	R13871	542-543	R13975	522-523	R14072	362-363
R13499	506-507	R13625	650-651		676-677	R13872	542-543	R13976	522-523	R14073	360-361
R13500	506-507	R13626	112-113	R13739	240-241	R13873	506-507	R13977	522-523	R14074	364-365
R13501	130-131		648-649		676-677	R13874	506-507	R13978	548-549	R14075	364-365
R13502	682-683	R13627	112-113	R13742	98-99	R13875	506-507	R13979	520-521	R14076	364-365
R13503	650-651		648-649	R13743	148-149	R13876	128-129	R13980	552-553	R14077	364-365
R13504	668-669	R13628	112-113	R13745	36-37		314-315	R13981	552-553	R14078	364-365
R13505	644-645		650-651	R13746	36-37		506-507	R13982	552-553	R14079	362-363
R13507	644-645	R13629	112-113	R13747	36-37		542-543	R13983	526-527	R14080	362-363
R13508	644-645		650-651	R13748	28-29	R13877	128-129	R13984	526-527	R14081	362-363
R13509	644-645	R13630	698-699	R13752	40-41		314-315	R13985	526-527	R14082	362-363
R13510	650-651	R13631	650-651	R13753	40-41		506-507	R13986	550-551	R14083	362-363
R13511	650-651	R13632	650-651	R13754	98-99		542-543	R13987	550-551	R14084	362-363
R13512	672-673	R13633	644-645	R13755	646-647	R13878	536-537	R13988	550-551	R14085	366-367
R13513	682-683	R13634	644-645	R13756	670-671	R13879	536-537	R13989	550-551	R14086	562-563
R13514	682-683	R13635	634-635	R13757	684-685	R13880	536-537	R13990	520-521	R14087	562-563
R13515	682-683	R13636	634-635	R13758	642-643	R13881	536-537	R13991	520-521	R14088	562-563
R13520	228-229	R13637	634-635	R13759	542-543	R13882	498-499	R13992	520-521	R14089	562-563
R13521	396-397	R13638	634-635	R13760	542-543	R13883	498-499	R13993	520-521	R14090	562-563
R13522	396-397	R13639	614-615	R13761	284-285	R13884	498-499	R13994	122-123	R14091	562-563
R13524	576-577	R13640	614-615	R13762	284-285	R13885	498-499		216-217	R14092	562-563
R13526	576-577	R13641	660-661	R13763	284-285	R13886	498-499	R13995	122-123	R14093	562-563
R13527	660-661	R13642	102-103	R13764	284-285	R13887	498-499		216-217	R14094	562-563
R13529	500-501	R13643	646-647	R13765	282-283	R13888	186-187	R13996	122-123	R14095	562-563
R13531	500-501	R13644	280-281	R13767	542-543	R13889	186-187		216-217		
R13535	512-513	R13645	280-281	R13769	538-539	R13890	278-279	R13997	210-211		
R13537	512-513	R13646									